

GETTING STARTED WITH MULTIBODY DYNAMICS

Joyce Tang – Application Engineer – September 2021

Inspire Motion

Agenda



What is MBD?



Software Demo



Benefits and Q&A

Evolution of Simulation-Driven Design

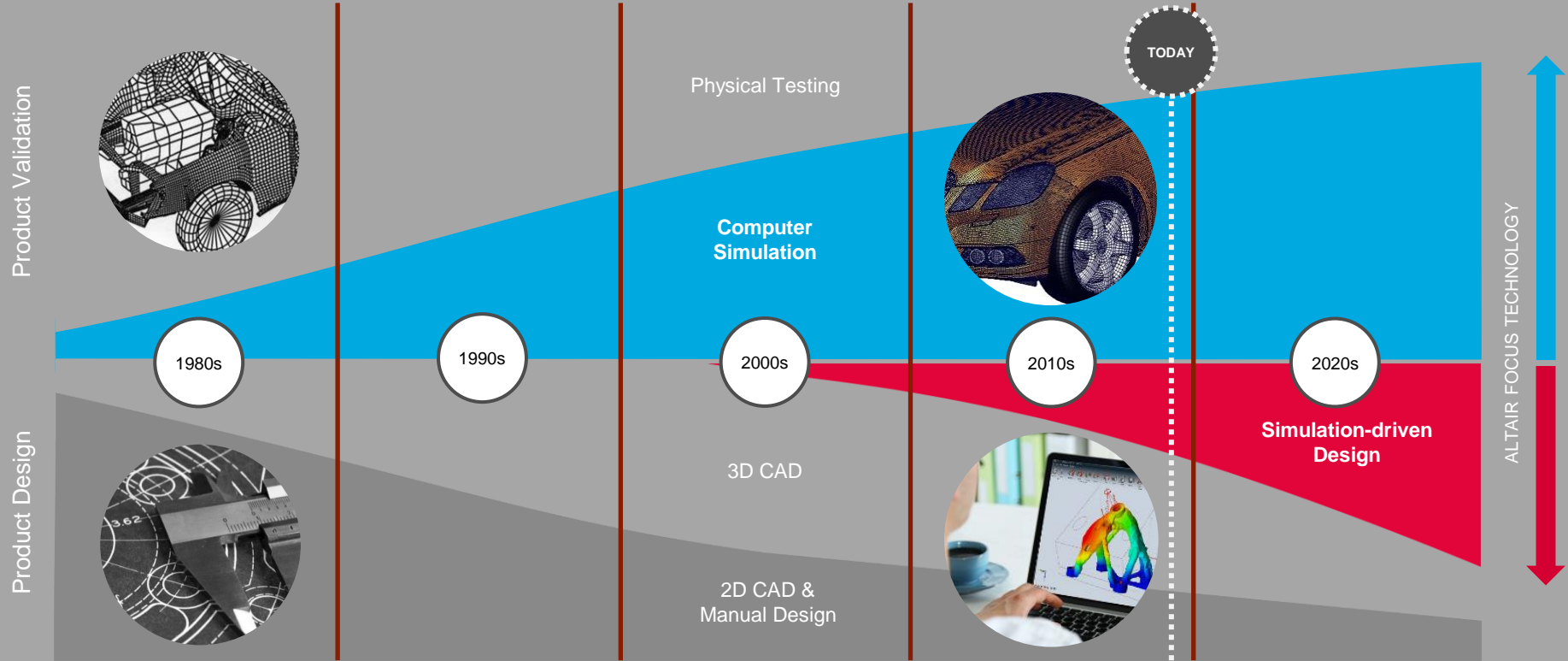

The Balancing Act

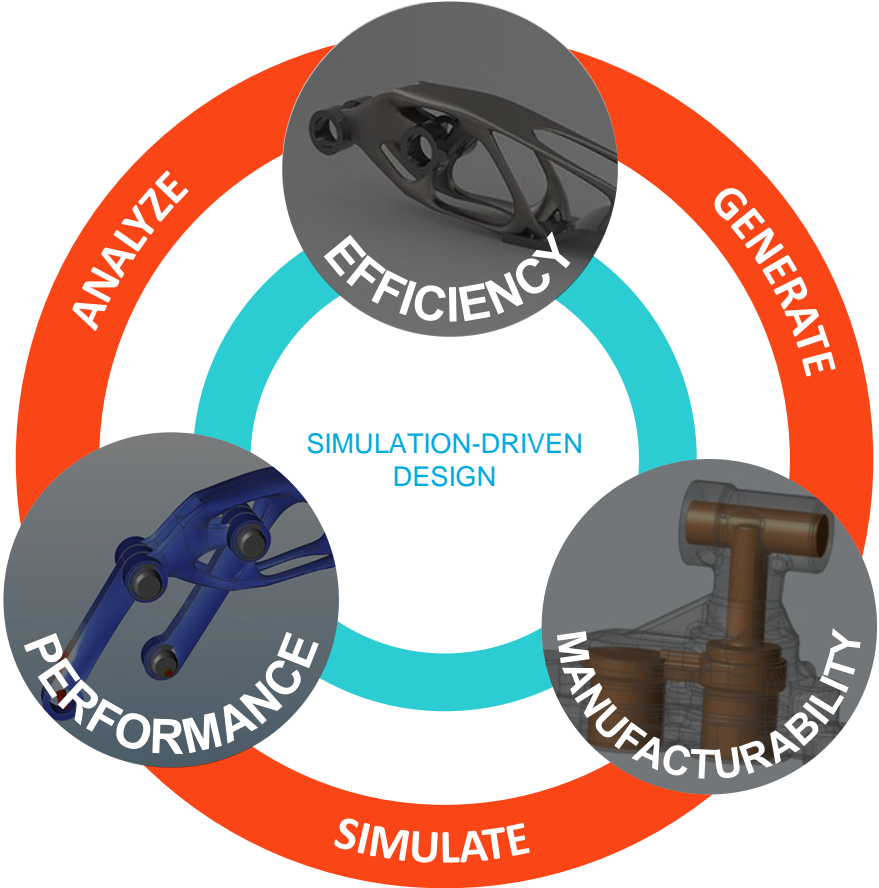

Disciplines

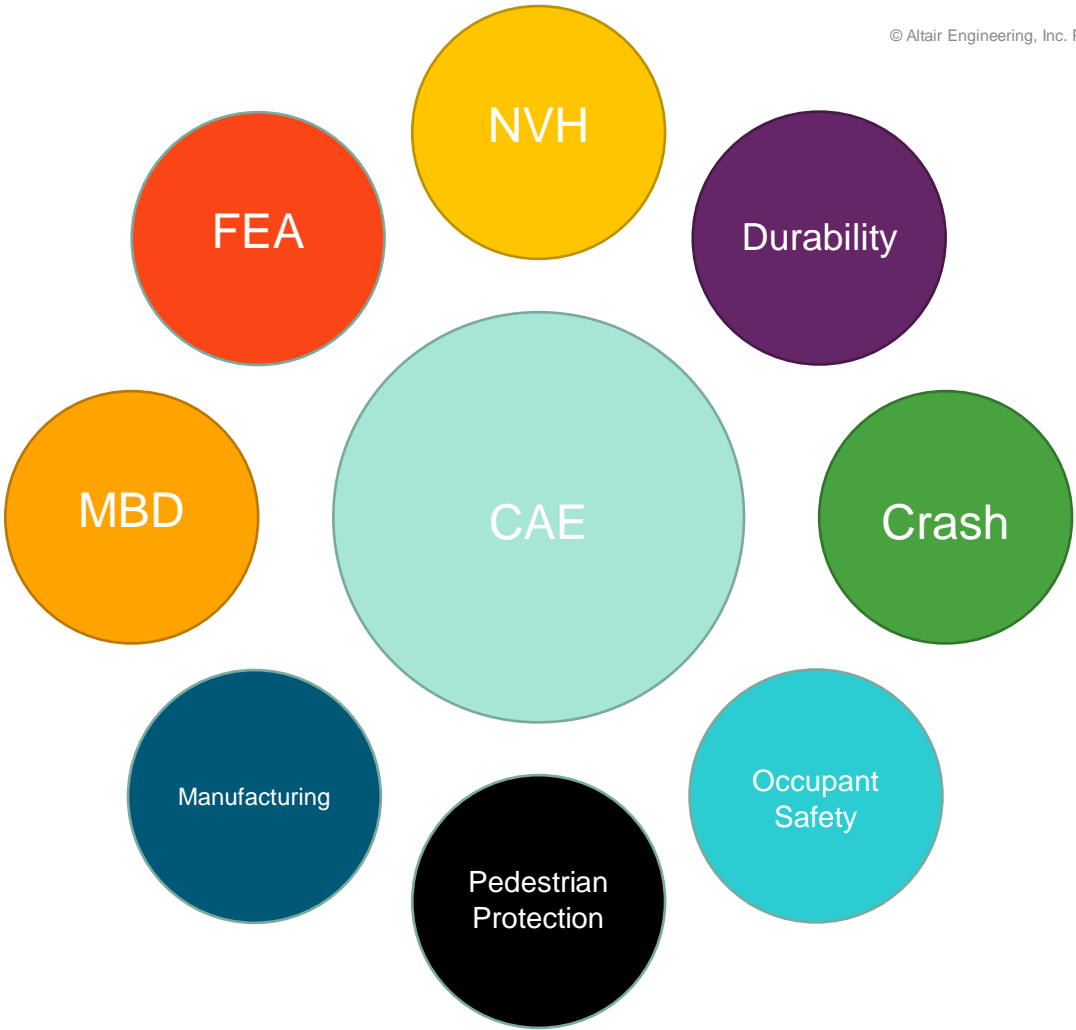

Disciplines

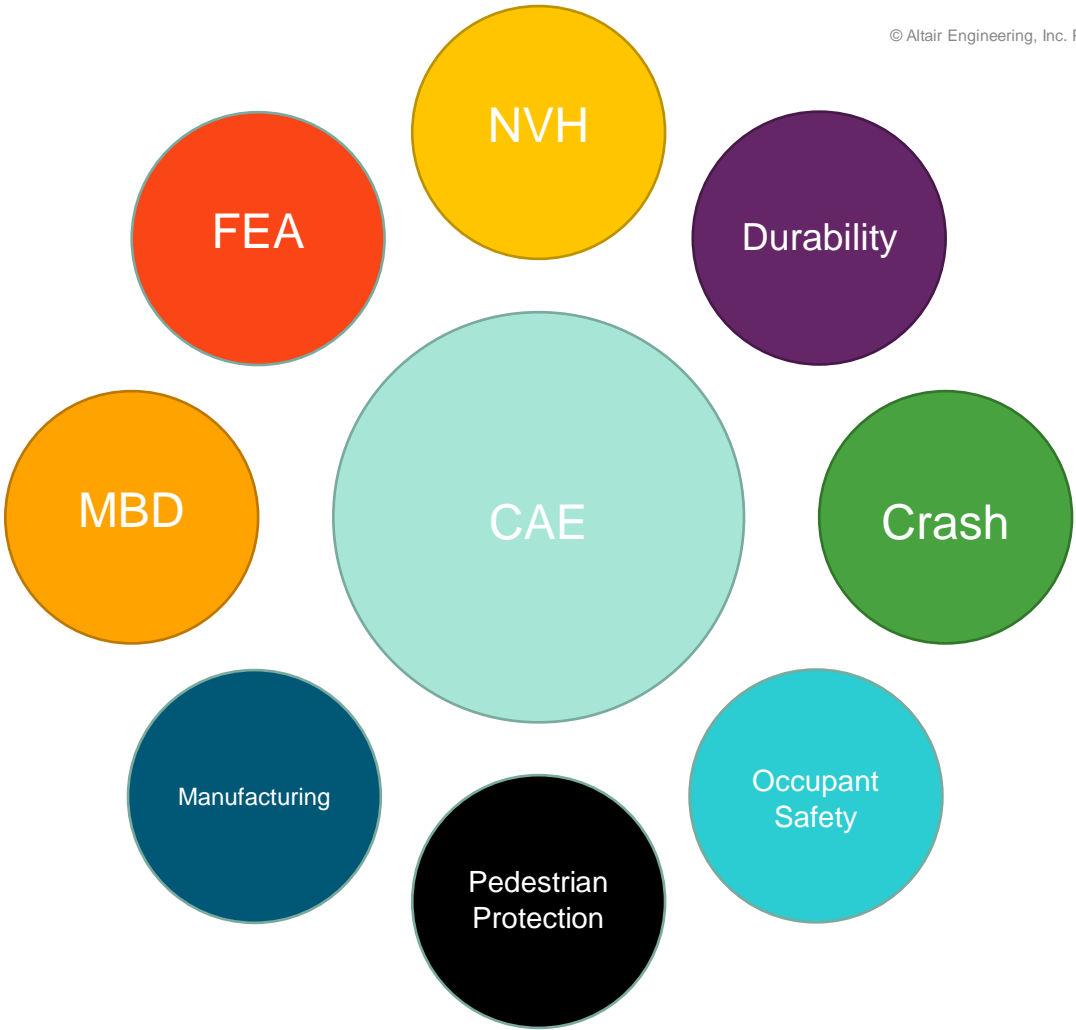

Workflows - FEA

How do we simulate our designs?

- 1) Physical Test -> Replicate
- 2) How it's used in real life -> Repli
- 3) MBD to Linear Static Analysis to O

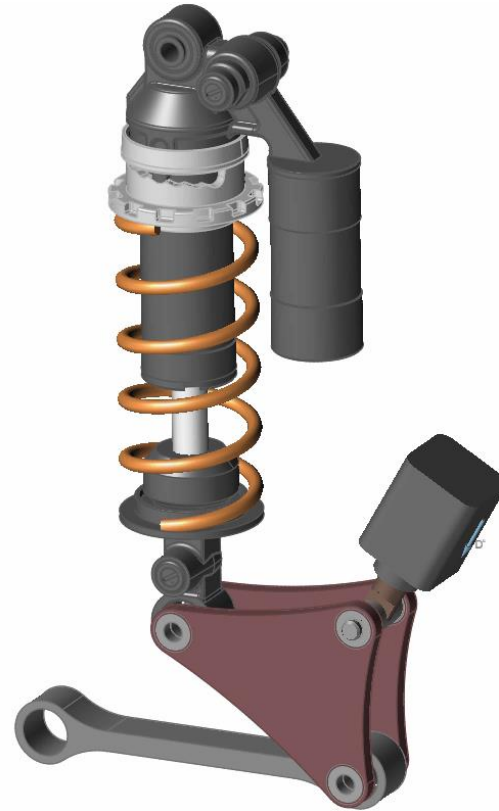

The Workflow

Structures



Multi-Body Dynamics



Structural Analysis



Optimisation

Multi-Body Dynamics

Why do we do it?

- To understand part assembly mechanisms
- To comprehend motion characteristics
- To design for its intended use
- To find generated loads on each component
- To take it through for a structural analysis

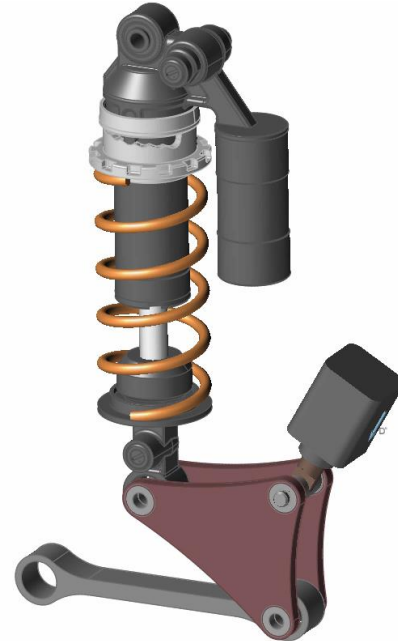

SOFTWARE DEMONSTRATION

Why do we use Inspire Motion?



Visualise

See how your mechanisms will move



Understand

Know what our component loads are



Optimise

Improve component behaviour given its motion



Save Time & Costs

Get results quickly and derive load cases for FE studies



Integrational

Easily share functional model between software and design teams

For More Advance MBD – use MotionView

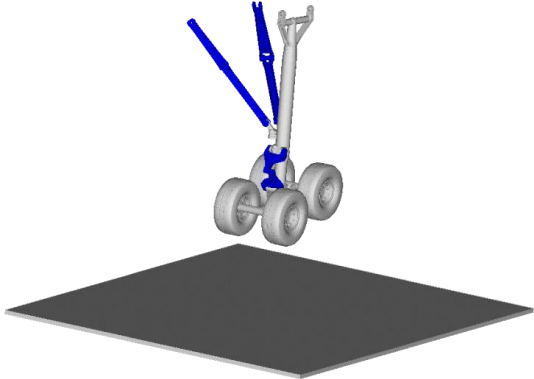
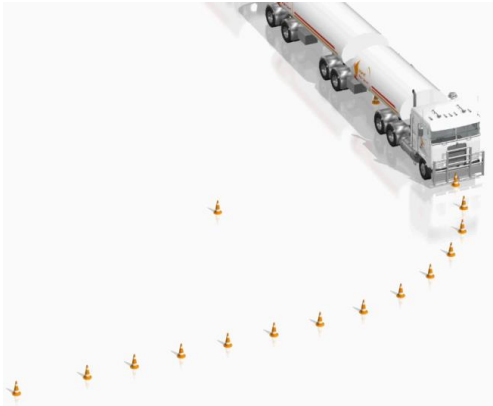
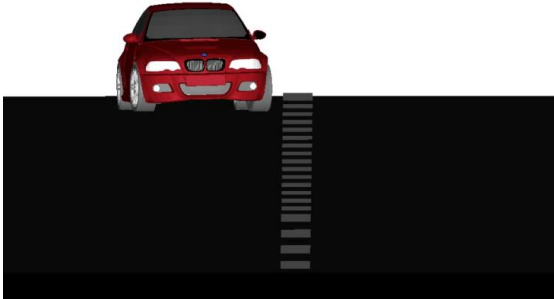

MotionView

Vehicle Library Wizard

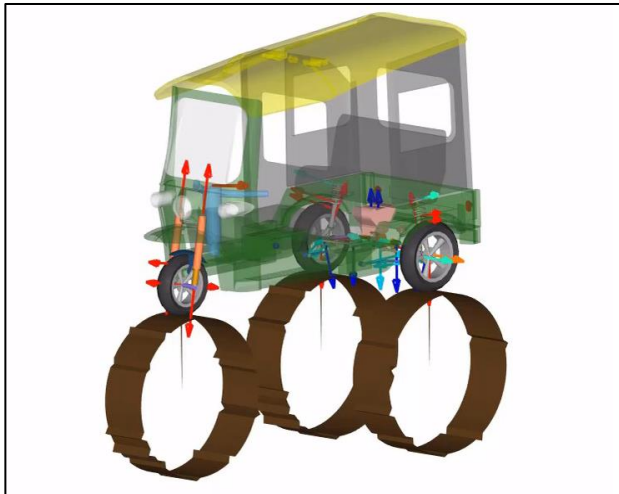
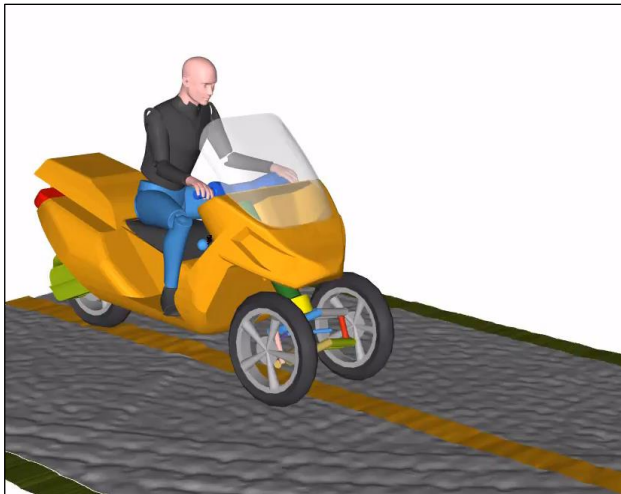
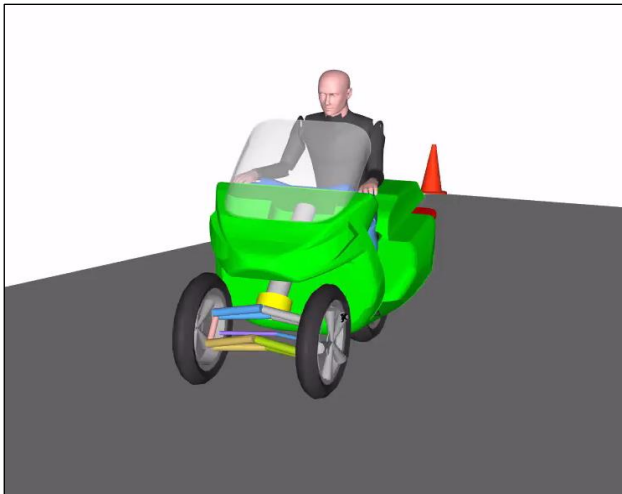

Vehicle Dynamics & Control

- Rider-machine interactions
- Vehicle stability and control
- Driver/passenger safety

Durability

- Component loads
- Component fatigue life
- Component damage

Ride and Comfort

- Vehicle response to road
- Rider response to road
- Active systems behavior

Benefits of Inspire Motion

Let's use MBD!

- ✓ Simulation Driven Design – full comprehension of your designs
- ✓ Quick and Efficient
- ✓ Uses MotionSolve – full capability and accurate MBD Solver
- ✓ Easily take it through to MotionView for more complex MBD analyses
- ✓ Optimisation derived from your MBD analysis

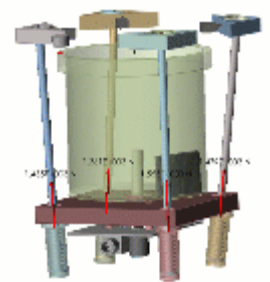
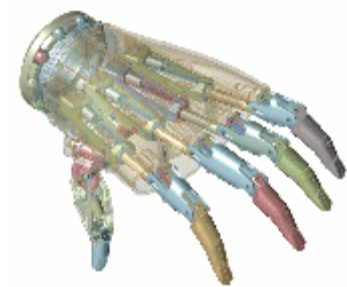
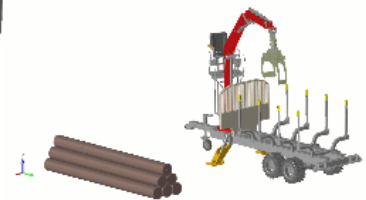
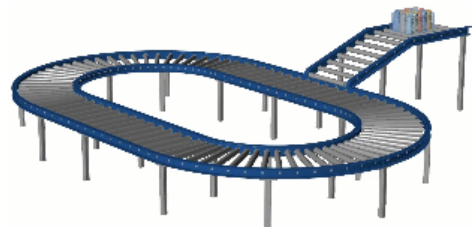



THANK YOU

altair.com



#ONLYFORWARD