

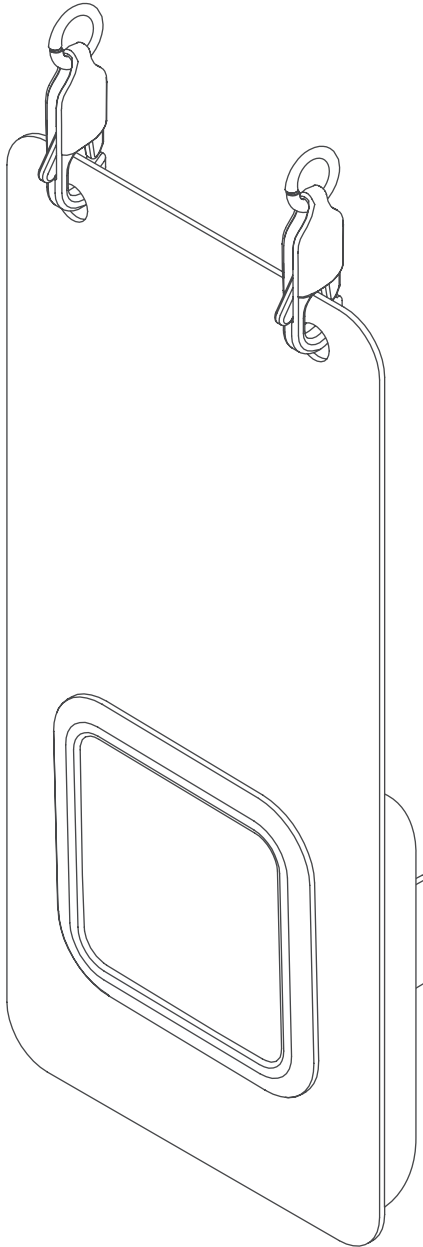



Backstage Pass with Lanyard

Assembly Instructions

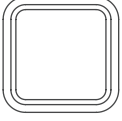

Keep the packaging box
for the return shipment.

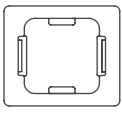
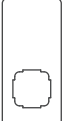
Parts List

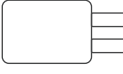
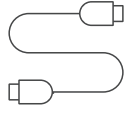
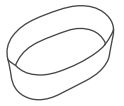
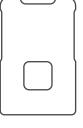
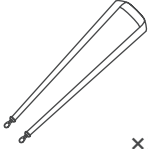
| | | | | | | | |
|---|--|--|--|---|--|---|--|
| Front Gasket  x1 | Device  x1 | Back Gasket  x1 | Signage  x1 | Battery Pack  x1 | Wall Plug  x1 | Charging Cable  x1 | Rubber Band  x1 |
| Back Plate  x1 | Lanyard  x1 | | | | | | |

Installation Steps

- 1 Attach front gasket to the device and insert it into the signage.
- 2 Secure the device and signage by attaching the back gasket.
- 3 Pull out rubber cap from the battery pack and plug it into the device.

- 4 Pull the rubber band to widen it and wrap around the battery pack and back gasket.

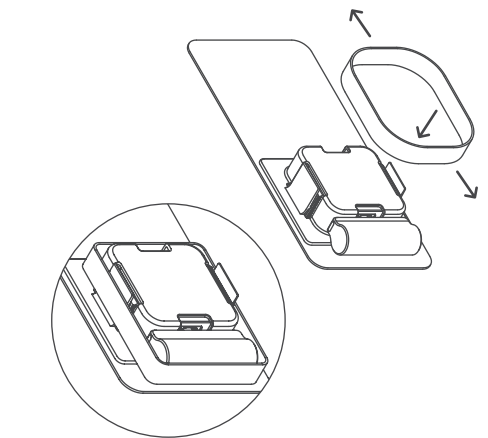

- 5 Peel off double sided tape covers on the back plate and attach it at the back gasket.

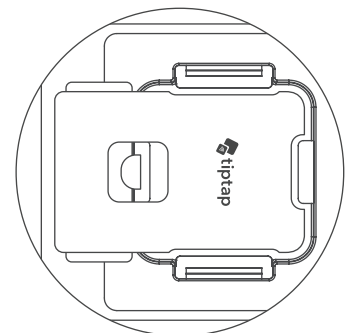

! Complete a full charge cycle before use.
Battery life is approximately 10 hours.

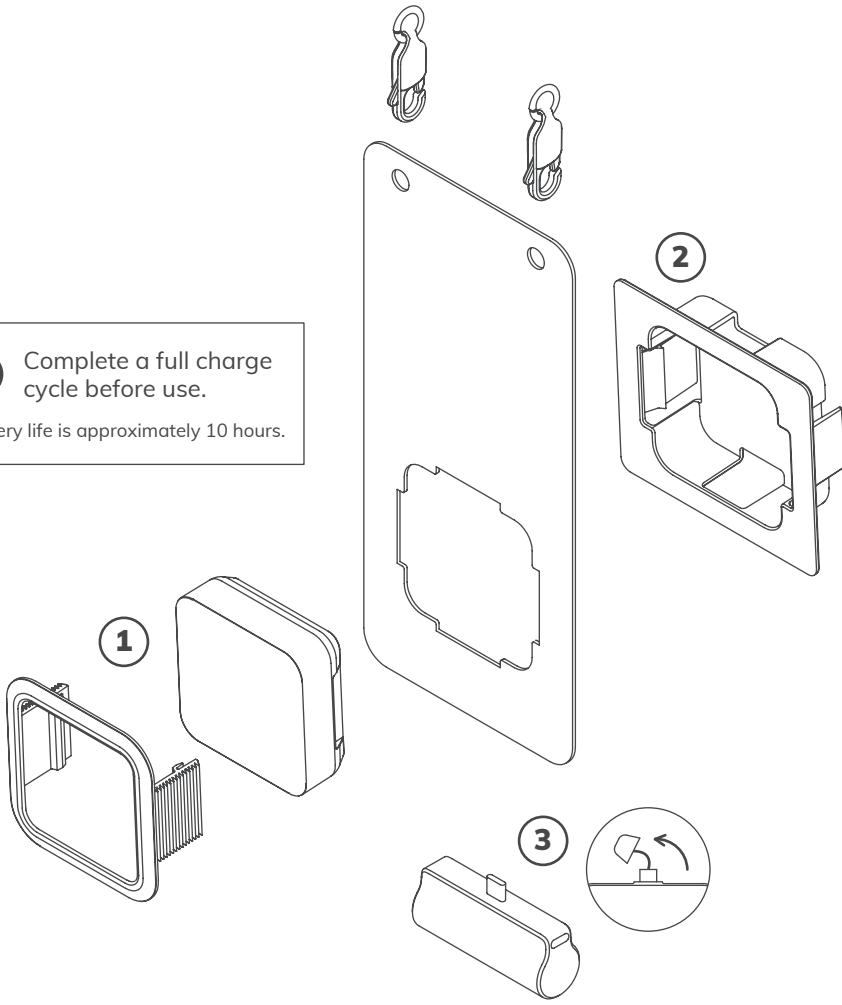

Return Shipping

Once the program has ended, pack the original contents in the box it arrived in and affix the return shipping label provided to the outside of the box. If you have misplaced the shipping label please email support@tiptappay.com and we will happily email you a replacement.