

THE WILDERNESS COLLECTION

44H Right side / Left side Double Glass/Protective Screen - Flush

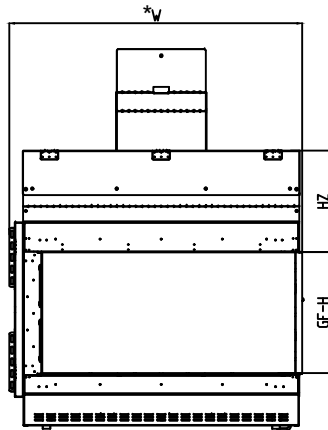

Front View

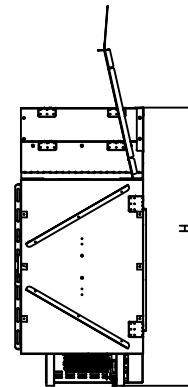

Side View

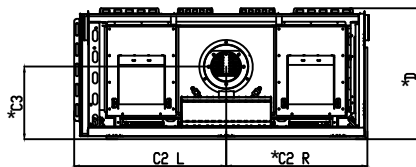

Top View

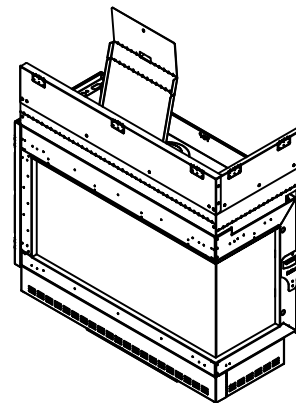

- Note : 1. on RS/LS Units C2 dimension is measured from glass side to the center of flue
 2. This drawing shows RS units. for LS units swap between C2 L and C2 R dimension

Model	(H) Height	(W) Width	(D) Depth	HZ	C1	C2 L	C2 R	C3	Glass Opening	
									(GF) Front	(GS) Side
44 H	49 1/4"	51 15/16"	23 1/4"	18"	7 7/8"	24 7/16"	25"	12 13/16"	46 3/16" W X 21 5/8" H	16 1/4" W X 21 5/8" H

* Dimensions include 1/2" lip (for drywall)

- Note : 1. Drawings are not to Scale
 2. All dimensions are in inches
 3. The dimensions are both for Double Glass and Protective Screen

THE WILDERNESS COLLECTION

44H Right side / Left side Double Glass/Protective Screen - Flush

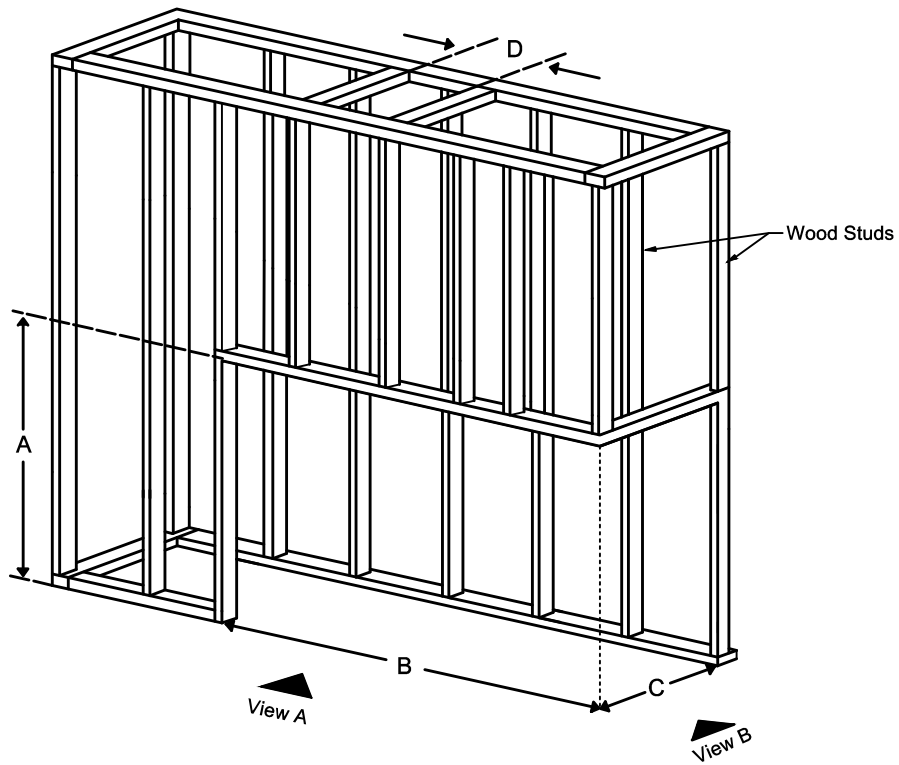

Model	A	B	C	D
44 H	49 1/4"	51 15/16"	22 3/4"	10"

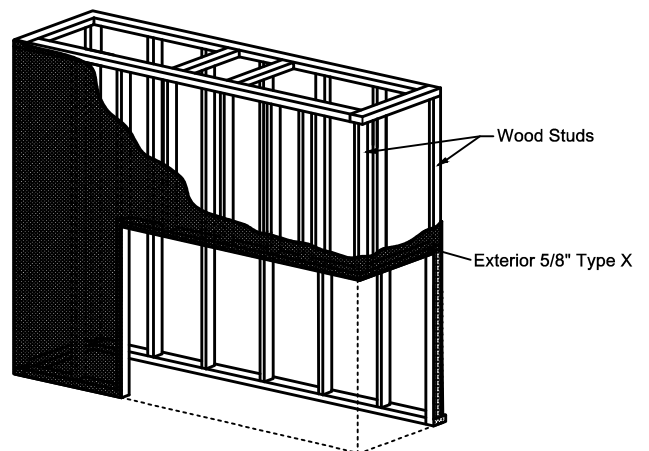

- Note :
1. Drawings are not to Scale
 2. All dimensions are in inches
 3. The dimensions are both for Double Glass and Protective Screen

THE WILDERNESS COLLECTION

44H Right side / Left side Double Glass/Protective Screen - Flush

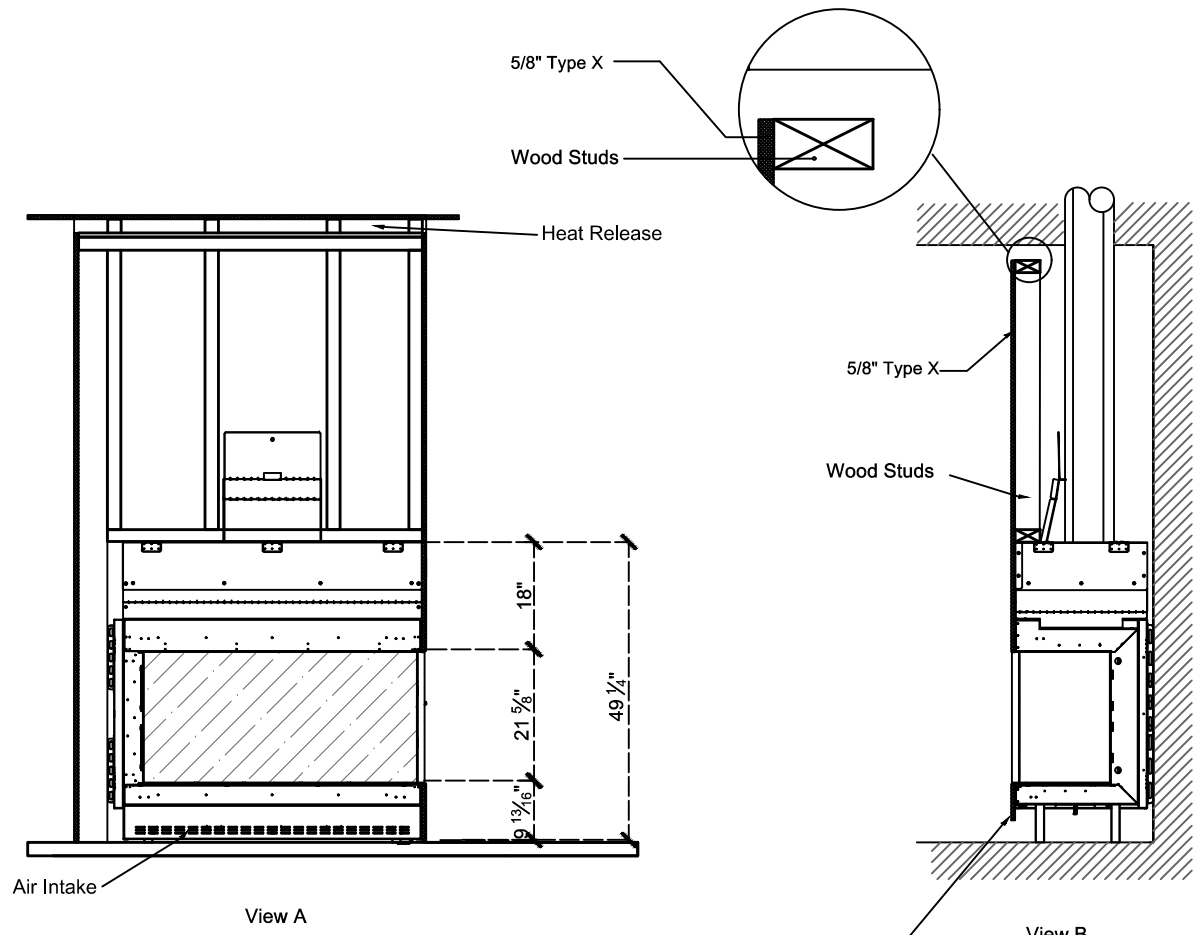

Add Drywall nailer as needed maintain 2" clearance to any part of Fireplace

Clearance 2" from each side to non combustible material.

The valve can be moved 36" - 40" from the center of the fireplace in any direction.

- Note :**
1. Drawings are not to Scale
 2. All dimensions are in inches
 3. The dimensions are both for Double Glass and Protective Screen