



TC-25CSS B-Chain Frequency and Temporal Response Analysis of Theatres and Dubbing Stages

*Prepared By The
Theatre Testing Data Report B-Chain Study Group*

1 October 2014



Table of Contents		Page
1	INTRODUCTION.....	1
2	SCOPE.....	1
3	OVERALL REPORT STRUCTURE.....	2
4	DEFINITIONS/TERMINOLOGY/ABBREVIATIONS/GLOSSARY.....	3
5	GOALS OF THE B-CHAIN STUDY GROUP.....	6
	5.1 Problems Identified.....	6
	5.2 Specific Goals.....	7
	5.3 Overview of Tasks.....	8
	5.4 Relationship Between Measured Acoustic Response and Aural Perception.....	8
6	OVERVIEW OF THE WORK OF THE THEATRE TESTING STUDY GROUP.....	9
	6.1 Specific goals addressed in this report.....	9
	6.2 Benchmark Measurement.....	9
	6.3 Venues Measured.....	9
	6.4 Calibration and equalization comparisons.....	11
	6.5 Close versus far field measurements.....	11
	6.6 Test signal comparisons.....	11
	6.7 Data Analysis Techniques.....	11
	6.8 Low Frequency Summation.....	12
7	MEASUREMENT METHODOLOGY.....	13
	7.1 Microphones.....	13
	7.2 Test Signals and Data Recording.....	13
	7.3 Matrix of Tests and Results.....	14
	7.4 Listening.....	26
8	FOUNDATION FOR THE DATA PROCESSING AND ANALYSIS.....	27
	8.1 Linearity.....	27
	8.2 Impulse Response.....	27
	8.3 Computation of Impulse Responses.....	28
	8.4 Computation of Frequency Response.....	29
	8.5 Time Windowing for Analysis.....	29
	8.6 Comparison of Real Time Analysis Method with Transfer Function Method.....	33
	8.7 Comparison of Pink Noise and Sine Sweep Test Signals.....	37
9	PROCESSING OF TEMPORAL RESPONSES.....	39
	9.1 Reverberation Time.....	39
	9.2 Cumulative Energy.....	41
10	PROCESSING OF FREQUENCY RESPONSES.....	42
	10.1 Normalization.....	42
	10.2 Spatial Averaging.....	44



10.3	Range of Responses Maximum and Minimum extremes	44
10.4	Smoothing.....	44
11	RESPONSES PRESENTED.....	45
11.1	Comparison of microphone position and time windows for left, center, right channels at listening positions	46
11.2	Comparison of microphone position for LFE channel at listening positions	46
11.3	Comparison of microphone position for surround channels at listening positions.....	46
11.4	Effect of Microphone Responses	46
11.5	Figure Numbering, Labeling and Missing Responses.....	47
12	COMPARATIVE ANALYSIS OF VENUES.....	47
12.1	Consideration of Frequency Responses	47
12.2	Summary of Venue Frequency Responses	52
12.3	Summary of Venue Temporal Responses	58
12.4	Comparison of Frequency Responses of Cinemas and Dubbing Stages.....	63
12.5	Applied Equalization	66
13	ANALYSIS, CONCLUSIONS AND SUMMARY	80
13.1	General Notes on the Testing	80
13.2	Data Analysis.....	80
13.3	Screen Channels	80
13.4	Surround Loudspeakers.....	81
13.5	LFE Responses	81
13.6	Low Frequency Response and Source Summation.....	82
13.7	Mid and High Responses.....	82
13.8	Close Field Responses	83
13.9	Temporal Responses	84
13.10	Effect of cinema screens	84
13.11	Current Deficiencies	85
13.12	Answers to Study Group Questions.....	85
13.13	“Lessons Learned”	87
13.14	General Observations	87
13.15	The future relies on education	88
13.16	Moving Forward.....	88
14	RECOMMENDATIONS FOR FURTHER WORK	89
15	RESPONSES OF CINEMA A	89
15.1	Centre Channel.....	89
15.2	Comparison of close-field (tree) and listening-area microphone positions for Center Channel.....	92
15.3	Comparison of Center Channel responses with different time windows at reference position.....	92
15.4	Effect of equalization on Center Channel and X curve.....	93



15.5	Comparison of front channels and time windows at Reference position	95
15.6	LFE Channel	98
15.7	Surround channels.....	100
15.8	Room Acoustic Measures	102
16	RESPONSES OF CINEMA B	104
16.1	Centre Channel.....	104
16.2	Close-field responses	107
16.3	Comparison of Center Channel responses with different time windows at reference position.....	108
16.4	Effect of equalization on Center Channel and X curve.....	108
16.5	Comparison of front channels and time windows at Reference position	110
16.6	LFE Channel	113
16.7	Surround channels.....	115
16.8	Room Acoustic Measures	119
17	RESPONSES OF CINEMA C	121
17.1	Centre Channel.....	121
17.2	Comparison of Center Channel responses with different time windows at reference position.....	124
17.3	Effect of equalization on Center Channel and X curve.....	124
17.4	Comparison of front channels and time windows at Reference position	126
17.5	LFE Channel	129
17.6	Surround channels.....	131
17.7	Room Acoustic Measures	134
18	RESPONSES OF CINEMA D	136
18.1	Centre Channel.....	136
18.2	Comparison of Center Channel responses with different time windows at reference position.....	139
18.3	Effect of equalization on Center Channel and X curve.....	139
18.4	Comparison of front channels and time windows at Reference position	141
18.5	LFE Channel	144
18.6	Surround channels.....	146
18.7	Room Acoustic Measures	149
19	RESPONSES OF DUBBING STAGE E	151
19.1	Centre Channel.....	151
19.2	Comparison of close-field (tree) and listening-area microphone positions for Center Channel	154
19.3	Comparison of Center Channel responses with different time windows at reference position.....	154
19.4	Effect of equalization on Center Channel and X curve.....	155
19.5	Comparison of front channels and time windows at Reference position	157



19.6	LFE Channel	160
19.7	Surround channels.....	162
19.8	Room Acoustic Measures	165
20	RESPONSES OF DUBBING STAGE F	167
20.1	Centre Channel.....	167
20.2	Comparison of close-field (tree) and listening-area microphone positions for Center Channel	170
20.3	Comparison of Center Channel responses with different time windows at reference position.....	170
20.4	Effect of equalization on Center Channel and X curve.....	170
20.5	Comparison of front channels and time windows at Reference position	173
20.6	LFE Channel	176
20.7	Surround channels.....	178
20.8	Room Acoustic Measures	181
Annex A	VENUE MICROPHONE LOCATIONS	183
A.1	Microphones Used	183
A.2	General Location of Microphones in Cinemas	183
A.3	Venue E (Dubbing Stage)	184
A.4	Venue F (Dubbing Stage).....	186
Annex B	BLOCK DIAGRAM OF TEST SETUP	188
Annex C	MATLAB CODE FOR DECONVOLUTION.....	189
Annex D	MEASUREMENT MICROPHONE TESTS BY THE STUDY GROUP	190
D.1	Introduction	190
D.2	The Measurement Microphone Comparison Test.....	190
D.3	Measurement Methodology.....	191
D.4	Conclusions.....	191
D.5	Measurement Data	191
Annex E	BIBLIOGRAPHY.....	219
Annex F	CREDITS.....	221



1 INTRODUCTION

The Theatre B-Chain Study Group was formed in March 2010 in response to the work statement that was approved by the SMPTE Standards Committee on 4 March 2010. The goal of the group was to study the current standards and practices regarding B-chain electroacoustic response and calibration, and make recommendations for work that SMPTE should undertake in these areas. During this 2.5-year study, the group tested many aspects of the subject.

The “Bench Testing” subgroup began by testing current electro-acoustic measurement analyzers under equal conditions, current calibration microphones with various angles of incidence, and created a set of test procedures to test actual theatres. These procedures included the creation of a detailed spreadsheet to capture data.

The “Theatre Testing” subgroup then set out to perform these tests on a reference theatre, dubbing stages and exhibition theatres. During the testing period, the group raised many questions and possible theories, and additional tests were devised to test them. These items became part of the tests conducted at the later venues. A large amount of data was amassed during the testing period.

The study group was able to glean some cogent observations from this work, and on June 22, 2012 submitted a report to the SMPTE Standards Committee with these observations and recommendations for further work. This resulted in the formation of the SMPTE Technology Committee on Cinema Sound Systems, TC-25CSS, on September 29, 2012.

A thorough analysis of the measured data was not possible during the tenure of the study group due to timing and resources. Therefore, one of the subgroups formed under TC-25CSS, the B-Chain Theatre Testing Data Report Study Group, was given this task. This report, with its analysis and conclusions, presents the work of the Data Report group and the B-Chain Study Group.

The analysis presented in this report has used the most up-to-date audio analysis techniques to evaluate the electro-acoustic performance of the tested systems, and their compliance with SMPTE ST202 and related Recommended Practices.

This work would not have been possible without the efforts of many dedicated people who gave their time and interest to the cause.

2 SCOPE

This report covers the theatre testing that was undertaken by the SMPTE B-chain Study Group and the subsequent analysis of the results undertaken by the 25CSS B-chain Theatre Testing Data Report Study Group.

The testing and analysis methodology, measurement response data and data analysis are presented, followed by conclusions and recommendations for further work.

3 OVERALL REPORT STRUCTURE

This report is divided in to the following sections:

- Section 4 provides a glossary with definitions of terms and abbreviations
- Section 5 notes the problems that were initially identified by the B-Chain Study Group and the specific goals and tasks that were formulated in response to those problems.
- Section 6 gives an overview of the work of the Theatre Testing Study Group, the measurement process that was implemented, and salient physical details of the six venues that were measured.
- Section 7 provides substantial detail about the measurement process.
- Section 8 discusses the technical foundations for the analysis of the measurement data using the transfer function method based on the impulse response. Discussion is given about the selection of a suitable time window. Comparison is made of the method used with RTA measurement methods and swept-sine stimuli.
- Section 9 describes the processing of the measured impulse responses to obtain a range of acoustic responses and metrics.
- Section 10 describes the processes that were applied to the frequency responses to aid analysis and comparison.
- Section 11 details the responses that have been developed.
- Section 12 presents the Part 1 analysis of the venue frequency and temporal responses. This is a summary analysis of each room highlighting details of the frequency and temporal response of the various systems in the venues.
 - Section 12.1 shows a summary of the frequency responses of each venue
 - Section 12.3 gives the temporal responses of each venue.
 - Section 12.4 compares the frequency responses of the cinemas and dubbing stages.
- Section 13 provides analysis, conclusions and a summary. This information is placed ahead of the detailed test responses for ease of readability.
- Section 14 makes recommendations for further work.
- Sections 15 to Section 20 present Part 2 of the Analysis. These sections provide an analysis of the frequency and temporal responses of each venue tested.
- Annexes and Attachments:
 - Annex A shows the locations of the microphones used to acquire the measurement data.
 - Annex B shows the block diagram of the test setup.
 - Annex C lists the code for MATLAB[®] software that was used to derive the impulse responses from the pink noise source and receive signals.
 - Annex D discusses microphone tests undertaken by the study group and contains their report.
 - Annex E provides a bibliography.
 - Annex F notes the credits for the work and report.



4 DEFINITIONS/TERMINOLOGY/ABBREVIATIONS/GLOSSARY

AHG – ad hoc group

B-chain – The portion of the sound system in a cinema space that reproduces the soundtrack in the theatre and includes signal processing specific to the loudspeakers, power amplifiers, and the screen channels, surround, and sub-woofer loudspeakers. It also includes the screen and the theatre acoustics.

Close-field – An arbitrary measurement location used in this report such that the distance from the microphone to the source is greater than the near-field and less than far-field locations.

Continental Seating – Seating where there is no center aisle, the row extends from side aisle to side aisle.

dB – decibel

DFT – Discrete Fourier Transform

EQ – equalization

Far-field – A measurement location such that the distance from the microphone to a sound source is many times greater than the physical dimensions of the source itself.

In this report, the distance of the audience microphones from the loudspeaker is sufficiently great to place those microphones in the far field of the loudspeakers.

FFT – Fast Fourier Transform

Flat Response – An adjective that describes a system's frequency response wherein the level across the frequency range of interest is within certain bounds, sometimes taken as ± 0 dB, but in practice is within a defined tolerance. In practice, the frequency response of a system is a system's response to a known signal, which typically can have equal amplitude per Hertz (white) or equal amplitude per fractional octave (pink). When represented graphically, a system with consistent response vs. frequency will describe a flat line when displayed with the appropriate bandwidth along the frequency axis. For white noise, the frequency axis steps are in unit Hertz. For pink noise the axis unit steps are fractions of an octave in bandwidth. It is this graphic representation to which we refer when we describe a system as having a flat response.

HF – high frequency

Hz – Hertz

Impulse Response – The impulse response function of a system is the output that results when the system is presented with a brief input signal called an impulse. The impulse response describes the reaction of the system as a function of time. As the impulse function contains all frequencies, the impulse response defines the response of a linear time-invariant system for all frequencies. (see below for a definition of "linear")

Linear System – An electronic system where the system output is linearly proportional, in some way, to the system input. In common terms, "linear" means that there is no non-linear distortion in the signal, such as THD or IMD. That is to say, signals A + B at the input give rise to only signals A + B at the output, independent of amplitude. Note: even if a linear system is equalized, such that the frequency response is no longer flat, the system remains linear.

LF – low frequency



Measurement Channels:

Single Channel: measurements where the signal fed to single input (e.g. from a microphone) is analyzed without reference to any other signal.

Dual Channel: measurements where the signal is effectively fed to two “inputs” and the signal on one input is analyzed with reference to the other input. The reference signal on the one of the “inputs” can take the form of an internal reference signal, or it can be a discrete signal fed to the second input of the system. The reference signal is usually a replica of the input signal to the system under test. Dual channel measurements can therefore be undertaken with a single actual channel. Dual channel measurements yield the transfer function of the system under test.

Minimum Phase – A minimum phase signal/system is one in which the phase shift associated with the amplitude response is the minimum that can be allowed while still exhibiting the properties of a causal system (one in which the output never arrives before the input). As there is a strict relationship between amplitude and phase in such systems, correcting either one will inevitably tend to correct the other. The essential factor is that there is no appreciable delay between the generation of the signal and the effect of whatever is influencing it. The low-frequency boost produced by mounting a loudspeaker flush into a wall is an example of a minimum phase response. Equalization of the boost to flatten the response will affect both amplitude and phase in the correct relationship, and hence will also restore the time (transient) response.

'Non–minimum phase' responses are those where correction of the amplitude response, including the associated phase response of that correction, cannot correct phase disturbances in the response. The far–field response of a loudspeaker in a reflective room is an example of a non–minimum phase system. In this situation, there is both a delay between the emitted signal and the superimposition of boundary reflections onto the overall response. In this situation, it is not possible to simultaneously equalize both the amplitude and phase responses. It is noted that the non–minimum phase component of the frequency response varies in greatly over a listening area.

ms – milliseconds

Near–field – A measurement location such that the distance from the microphone to a sound source is less than the physical dimensions of the source itself.

Pink Noise – A signal where the spectrum has a $1/f$ power spectral density, or the energy per Hz. It is inversely proportional to frequency such that each octave, or similar log bandwidth, and contains an equal amount of energy. The amplitude of the noise is characterized by the probability measures mean, standard deviation, skew (asymmetry), and kurtosis.

PPO– Points Per Octave – An expression of frequency resolution referring to the number of frequency divisions or analysis points within an octave bandwidth.

RTA – Real Time Analyzer (usually a single channel measurement system - see under Measurement Channels)

Schroeder Decay Plot. – 'A reverse time integration method that transforms the room impulse response into a decay plot. This decay plot is identical to the average over infinitely many decay plot that would be obtained from energizing the room with bandpass–filtered noise - see Refs (5),(6).

Sloped Seating – The increase in height of the floor from front to back is sufficiently small to not require steps as one moves back in the seating area.

Spatial Averaging – The mathematical mean value of the sound pressure level over multiple points in space. The mean value can be determined using an arithmetic or power average.

$$\text{Arithmetic average: } SPL_{ave} = \frac{1}{N} \cdot (SPL_1 + SPL_2 + SPL_3 \dots SPL_N)$$

$$\text{power average: } SPL_{ave} = 10 * \log \left(10^{\left(\frac{SPL_1}{10}\right)} + 10^{\left(\frac{SPL_2}{10}\right)} + 10^{\left(\frac{SPL_3}{10}\right)} \dots 10^{\left(\frac{SPL_N}{10}\right)} \right) - 10 * \log(N)$$

where N is the number of positions

Stadium Seating – Seating where the change in elevation from front seating to rear seating is sufficiently steep to preclude a sloped seating configuration and which requires a stepped floor surface between the front and rear seating.

Time Blind Measurement – A technique that involves measurement of a system’s output signal by a device with a single measurement channel without any reference to the relative phase of the input signal. Measurements of this type cannot establish a system’s transfer function. As the measurement is blind to time-related data, it aggregates all sounds arriving at the measurement microphone regardless of their arrival time. The measurement therefore cannot differentiate between the direct sound field, reflections and reverberant sounds. This is unlike human hearing, which responds differently to sounds arriving from different directions and at different times.

Time Window – A mathematical function that is zero–function outside a chosen interval and has the specific value inside the interval. The equations given below are discrete equations, for an interval of N samples of n .

Hann Window – A mathematical function that is zero outside a chosen interval and has the value of a raised cosine function inside the interval, reaching the value 1 at the center of the interval and zero at each end. It has the form:

$$\omega(n) = 0.5 \left(1 - \cos \left(\frac{2\pi n}{N - 1} \right) \right)$$

half Tukey Window – A mathematical function that is zero–function outside a chosen interval and has the specific value inside the interval: The equations given below are discrete equations, for an interval of N samples of n .

$$T(n) = \left\{ \begin{array}{ll} 0 & \text{for } n < 0, n \geq N \\ 0.5 \left[1 + \cos \left(\pi \frac{n - \alpha N}{1 - \alpha N} \right) \right] & \text{for } \alpha N \leq n < N \\ 1 & \text{for } 0 \leq n \leq \alpha N \end{array} \right\}$$

The half Tukey window consists of half of a cosine lobe of width $N \alpha/2$ that is appended to a rectangular window of length $N(1 - \alpha/2)$.

When $\alpha=0$, a Tukey window becomes a rectangular window, and with $\alpha=1$ it becomes a Hann window. In the half Tukey windows used for this analysis, the value of α is 0.75, meaning that the rectangular portion of the window is 75% of the stated duration, with the cosine portion constituting the remaining 25%.

Rectangular Window – a mathematical function that is zero–function outside a chosen interval and has the value of 1 inside the interval. It has the form:

$$T(n) = \left\{ \begin{array}{l} 0 \text{ for } n < 0, n > N \\ 1 \text{ for } 0 \leq n \leq N \end{array} \right\}$$



Transfer Function – A mathematical function describing the response of a system to a defined input stimulus. The transfer function is the output of a system divided by the input to the system and includes both time and frequency components. In the frequency domain, the transfer function takes the form of the Frequency Response Function, which shows the amplitude and phase response of the system. In the time domain, the transfer function is expressed as the Impulse Response (see definition above), which shows the time-pattern of arrivals of the output signal.

The transfer function of a system can only be measured by an analyzer that is not “time blind.” Transfer function analyzers usually allow the user to examine the impulse response in order to differentiate the direct sound from reflections and reverberant sounds, which allows the acoustic measurement to more closely approximate human hearing.

5 GOALS OF THE B-CHAIN STUDY GROUP

The current SMPTE standards and practices regarding theatre B-chain electroacoustic response and calibration (8), (9) were formulated in the 1970’s using the sound systems and technology available at the time. Those standards have since remained essentially the same although the soundtrack format delivered to theatres with Digital Cinema Distribution Masters has now become uncompressed digital audio. When the B-Chain Study Group undertook their effort, one of the primary aims was to determine if the underlying principles still applied in the current landscape, or if recent research and modern measurement techniques indicated the need for a change. Therefore, the group sought to test these principles and evaluate the results of the calibration methods under the current standards to determine if they are providing consistent and reliable results.

The overarching goal was to gain an understanding of the state of the industry today, learn about methods currently employed, and determine if better methods exist.

5.1 Problems Identified

At the beginning of the project, the group identified these problems that needed to be addressed:

1. Cinema sound quality is inconsistent:
 - between dubbing theatres and exhibition theatres, and
 - between exhibition theatres.

These issues are discussed by Vessa and Weinberg in (7).
2. Attaining sound in a commercial theatre that is consistent with the best dubbing theatres currently requires a combination of an above-average sound system, a skilled technician who understands how to make and interpret measurements, and one or more sets of highly trained ears. While this is realistically possible for dubbing rooms, high-end theatres that have the resources, and facilities that host special events (such as premier screenings), it is not possible for most theatres. Therefore, the sound in theatres varies greatly and is often underwhelming.

Notable contributors to this situation are:

- Inadequate sound-system performance;
- Incorrect B-chain set-up and calibration;
- Excessive processing (such as equalization); and
- Inappropriate room acoustics and screen characteristics.



3. Electro-acoustic measurement methods systems continue to improve, with the result that users may not understand how to properly apply modern measurement tools and audio processing techniques in the setup of the cinema B-chain.
4. The current active standard documents SMPTE ST 202, SMPTE RP 200 and ISO 2969 are specific to measurement techniques and values involving single channel (and therefore time blind) measurements with pink noise, deep into the theatre seating area.

A number of experts have found problems with such techniques, and have suggested the existing procedures be reviewed (1),(2),(3),(4). More recent measurement techniques such as dual channel measurement systems are available and their use should be explored.

5. Sound reproduction equipment has improved and continues to improve. Some of today's cinema sound systems do not utilize advantages that could be derived from the use of more contemporary equipment and acoustic measuring techniques. Cinema sound reproduction might benefit from many of these newer technologies including better audience coverage, higher intelligibility, and increased fidelity, clarity and naturalness.
6. This sound reproduction system improvement and the overall improvement in the quality of source material may indicate that the reproduction EQ curve parameters be revisited.

5.2 Specific Goals

The group established the following specific goals for the study:

1. Find a measurement system and procedure that can objectively reflect what we aurally perceive as close as is reasonably possible, and does not require aural evaluation to finalize calibration
2. Report on aspects where additional guidance and direction is needed in the measurement and setup for the audio B-chain in screening rooms and cinemas.
3. Review current B chain components and implementations in small, medium and large rooms.
4. Report on any issues found with the currently specified X curve which may result in a recommendation to revise or supplement the ST 202 "X curve" characteristics.
5. Review current sound reproduction systems that are being used for cinema exhibition and their appropriateness for standardization. Editorial Note: This has not yet been done.
6. Examine the task of measuring the acoustical response of current playback equipment systems in the cinema environment. This is the subject of the remainder of this report.
7. Submit recommendations for further standards work as appropriate based on the findings of the study group.

After initial study and discussion, the group determined that basic scientific data was needed and determined the following related goals:

- Provide insight into the electroacoustic frequency response performance of the sound systems in the theatres and dubbing suites that have been measured, noting their similarities and differences.
- Gain an understanding of the causes of differences in frequency responses and time-domain performances, which can vary with a microphone's or a listener's room position.



- Use a method in which the summarized, comparative results are traceable back to the original measurement data. In this way, the source of details underpinning trends can be examined.

The method used to calculate the responses should yield results that can be shown to be consistent with other techniques.

5.3 Overview of Tasks

The group laid out the following specific tasks:

1. Investigate B-chain sound system measurement methods that might improve the calibrated-performance quality and uniformity of movie-theatre and dubbing/screening-room B-chains, and reduce the variability of technicians' system calibration results. This work includes:
 - Review and report on electro-acoustic measurement techniques not addressed in ST 202.
 - Analyzing the SMPTE ST 202 X-curve measured room-response target and tolerances.
2. Review and report on current and alternative equipment setup techniques.
3. Review and report on equipment design parameters, such as required headroom, as it relates to modern cinema sound systems. Editorial note: This has not yet been done.
4. Consider B-chain system-components' performance characteristics with respect to the demands of movie soundtracks and other theatre programming, which might warrant SMPTE B-chain system-components' performance standards, engineering guidelines, or recommended practices.
5. Review and report on the need for either updating the current X-curve, or creating a new B-chain document which delineates a new playback EQ curve that reflects the state-of-the-art in audio reproduction equipment and theatre screens. Editorial note: This is proposed to follow after this report.
6. Recommend to the SMPTE Standards Committee specific topics for further efforts toward modifying or generating SMPTE standards, recommended practices, and engineering guidelines plus suggestions for related activities.
7. Investigate possible liaisons with other interested bodies to participate in this work.

5.4 Relationship Between Measured Acoustic Response and Aural Perception

It was determined early in the process that the ultimate goal was to attempt to correlate measured electroacoustic response with aural perception. The group defined this goal as follows:

Determine if one or more measurement methods and technologies exist that can be used to measure and calibrate dubbing-stage and exhibition-theatre B-chains such that aurally perceived sound is:

- Substantially more consistent theatre-to-theatre;
- Satisfactorily repeatable with successive calibrations in a given theatre;
- Less dependent on the theatre technician's skill, talent, and hearing acuity; and
- To a reasonable degree independent of a theatre's equipment and acoustics.

The group recognizes that scientific, subjective testing is a necessary audio test tool. To this end, test material was collected for playing at the venues, with the goal of undertaking subjective testing along with the objective testing.



The intention was to listen to this material for each calibration undertaken in the theatre and attempt to correlate what was heard with what was measured. The group did this when possible, but unfortunately time did not permit a thorough and rigorous aural testing at each venue. Therefore, while the group did agree on some subjective impressions, there is insufficient hard data to actually present in this report.

The group did agree that what is measured with current technology and what is heard do not necessarily correlate. Systems that measure similarly and comply with the current standard often sound very different.

Acoustics experts currently see frequency response data derived from impulse response (IR) measurements as most accurately reflecting what we will hear. With IR measurements, it is possible to determine the frequency response of the direct sound without the effect of later arriving reflections and reverberation. The human process makes determinations regarding clarity, intimacy and engagement and some timbre determinations on the direct sound and early reflections without the effects of reverberation (10),(11),(12). However, some aspects of timbre are strongly related to the reverberant field.

More work is needed in this area, which will be undertaken by TC-25CSS in the future.

6 OVERVIEW OF THE WORK OF THE THEATRE TESTING STUDY GROUP

As one of the specific tasks of the 2010 B-Chain Study Group, the acoustical performance a number of cinema venues was examined using the procedures developed by the Bench Testing Subgroup. The six venues included a reference theatre, dubbing stages and exhibition theatres.

A large amount of data was amassed during the testing period; however, a thorough analysis of the measured data was not possible during the tenure of the B-Chain Study Group due to time and resource limitations. The remaining tasks were to analyze the measured data, formalize procedures, compile lessons learned, generate recommendations from the sub-group measurement work, and prepare a final report. This analysis is the subject of this report.

6.1 Specific goals addressed in this report

1. The large amount of data needs to be reduced, using methods agreed by group consensus, to a form that enables analysis by the study group members.
2. Develop charts, graphs, and other graphic elements necessary for interpretation of the data.
3. Analyze the data and reach consensus on the results and presentation format.
4. Generate a report that summarizes the sub-group measurement set-up and measurement procedures, the data, the analysis, and a conclusion with recommendations to the 25CSS parent committee.

6.2 Benchmark Measurement

At the beginning of the testing process, the theatre testing group agreed to test a “benchmark” cinema, which was a well-known and well-regarded reference theatre, and compare the sound and its measured responses to the other mixing and exhibition theatres. This is Venue B in this report.

6.3 Venues Measured

This report presents the analysis of the data collected at the six venues.

The venues included three commercial cinemas (type 1), the reference theatre (type 2)], and two dubbing theatres (type 3). A condition for SG access to these venues was to keep their identity anonymous. A summary identifying the venues by number is presented in Table 1.

Table 1 Characteristics of Theatre B-chain SG measurement venues

Venue/ Attribute	A	B (g)	C	D	E	F
Type	1	2	1	1	3	3
# of seats (a)	697/2 L	288/2 L	317/2 S	485/2 S	4/4	2/2
Seat pitch	0.97 m (3'-2")	1.04 m (3'-5")	1.27 m (4'-2")	1.15 m (3'-9")	A/C	A/U
Seat width	0.56 m (1'-10")	0.61 m (2'-0")	0.61 m (2'-0")	0.61 m (2'-0")	A/C	A/U
Depth (b)	31.0 m (101'-6")	18.1 m (59'-2")	23.9 m (78'-8")	26.1 m (85'-9")	18.82 m (65'-0")	16.51 m (54'-2")
Width (c)	17.6 m (57'-10")	13.3 m (43'-6") at screen to 18.3 m (60'-0") at last row	18.1 m (59'-4")	23.7 m (77'-9")	13.72 m (45'-0")	9.71 m (31'-10")
B-chain (d)	5.1/7.1	5.1/7.1	5.1/7.1	5.1/7.1	5.1/7.1	5.1/7.1
Screen Size (e)	12.0 m x 5.3 m (39'-6" x 17'-6")	12.8 m x 6.1 m (42'-0" x 20'-0")	17.1 m x 8.5 m (56'-0" x 28'-0")	20.1 m x 12.8 m (66'-0" x 42'-0")	11.6 m x 5.2 m (38'-0" x 17'-0")	7.6 m X 3.0 m (25'-0" x 10'-0")
Screen Type (f)	Theatre Perforated Vinyl	Perforated Vinyl Cinemaparf	Theatre Perforated Vinyl	Theatre Perforated Vinyl	Perforated Vinyl - Cinemaparf	Woven

Notes:

- a. 1 = center longitudinal aisle; 2 = two longitudinal aisles; S = stadium profile L = sloped profile, A = Aeron, C = Couch, U = Leather seat
- b. distance from screen center to last row of seating
- c. distance from side wall to side wall
- d. B-chain playback configuration (5.1, 7.1, etc.)
- e. Screen size is approximate
- f. Screen type information was given by the individual venues
- g. Theatre has a reduced height non-seating area behind the last row of seats.

6.3.1 Screen, surrounds and subwoofer testing

The group noted that surround and subwoofer test procedures have not received the same attention as the screen speakers in the literature, and the standard for subwoofer calibration is especially lacking. In each venue, the group tested at a minimum the following systems:

- The center screen loudspeaker.
- One set of surround arrays e.g. Left Surround in 5.1 configuration and Left Side Surround and Left Rear Surround in 7.1 configuration.
- The subwoofer (LFE) response with all subwoofer loudspeaker drivers on.



If time permitted, the other channels were tested as well. In some venues a complete set of data was not captured due to time constraints.

6.4 Calibration and equalization comparisons

An important aspect of the testing was to determine the effect of system equalization on both measured response and aural perception. In Venues A, E and F,, the systems were measured twice – first with the equalization “as found”, and then with the equalization bypassed. In some of the venues, the system was equalized by the testing group based on real-time analysis performed at the venue. In some cases it was possible to try two different equalizations. The group-equalized settings were used in listening evaluation, but the measured responses are not presented here.

The results of the measured responses for the “as found” and “bypassed” equalization states are presented for the center screen loudspeaker, surround and LFE channels. In some cases time did not permit measurement of both the “as found” and “bypassed” equalization states. The amount of equalization that was applied in the “as found” condition is determined for the center screen loudspeaker of three venues

6.5 Close versus far field measurements

The group also wished to determine if acoustic measurements made in the close-field of the loudspeakers would provide additional information and insight into the sound system’s behavior beyond that obtained using far-field measurements.

Issues to be explored were:

- Would measuring in the close field and measuring in the far field give significantly different results?
- Would the X-curve still manifest in the close field, or is this only a far field phenomenon?
- Would the high frequency response be flatter in the close field measurement and exhibit more roll-off in the far field?

For the venues where the time on site allowed making these measurements the comparisons are presented.

6.6 Test signal comparisons

Fundamental to the current SMPTE ST 202 and RP 200 is the use of wideband pink noise. The study group wished to test other signals as well to determine if some may be better suited for certain test criteria. Testing was done in later venues by performing the same measurement with sweep tones and then different pink noise files, such as those on a commercially available test disk, hardware platforms, or software programs. While the testing was not exhaustive, some data was gathered, which is presented here.

6.7 Data Analysis Techniques

An important aspect of the testing was to determine if different analysis techniques produced results that were more consistent and useful than the 1/3 octave real time analyzer (RTA) technique described in SMPTE ST 202.

It was of interest to determine the difference between the “time-blind” 1/3rd octave-band RTA, single-channel, measurements and “time-smart”, dual-channel analyzers which measure the system impulse response in order to compute the frequency response.

Being time blind, single-channel analyzers:



- cannot provide the complex response of the device under test, which by definition would include both the magnitude and phase response
Although the phase response of the systems is not presented in this report, phase information is essential to the checking of driver polarities and development of crossovers (if needed).
- cannot show the way that the total system (loudspeaker plus room) frequency response evolves over time at a specific location
- cannot differentiate between direct (first arrival) sound and later sound (reflections) and therefore cannot indicate how the reproduced sound would be perceived by our hearing system which is dependent on the direct sound.

As the size of a room and its acoustic finishes affect the temporal response of a sound system, the effects of different time window sizes on the responses obtained with a dual channel FFT method are presented.

For this report, the computation of the impulse response and the associated frequency responses in batch format was undertaken using MATLAB[®] software. The code was written by Glenn Leembruggen and colleagues in Australia.

An important benefit of using the MATLAB[®] method was the ability to automatically process a very large set of recorded .WAV files. This process eliminated the need for any manual loading, processing and saving of the results by the operator, thereby removing the risk of errors.

It is important to note that the MATLAB[®] code is intended to replicate the calculations provided by commercially available dual-channel analyzers that are capable of:

- Deriving the impulse response of a transmission system.
- Truncating the impulse response with different length windows.
- Smoothing the response with a moving average.

6.8 Low Frequency Summation

The perception of low frequency sound in a cinema depends on the way in which the re-recording sound mixer allocated the low frequency (bass and sub-bass) content among the playback channels. This artistic decision can affect the perception, and measurement, of these sounds.

For example, if the re-recording engineer mixed the bass and sub-bass content into many channels, the result may sound, and therefore measure, quite differently than if the sub-bass content is sent only to the LFE channel. This is an artistic decision, as there are many possibilities open to the re-recording mixer, and therefore the results can vary.

The measurements undertaken in this study are of the loudspeaker chain by specific channel, and not the summation of the various sources that could contain low frequency content. In this sense, the measurement results will not necessarily reflect what is heard in the room with movie soundtrack content.

7 MEASUREMENT METHODOLOGY

7.1 Microphones

The group wished to test the effects of different microphones and setup techniques on the measured data. The baseline microphone setup used was as depicted in ST-202, and other techniques were tested in various venues. In addition, a comparison of current measurement microphones was performed by the Bench Testing group, which is presented in Annex D.

7.1.1 Types

A common set of five microphones; Audix[®] TM1 (omnidirectional free-field), was used in Venues A and C through F, while a different set of five microphones, Beyer MM-1 (omnidirectional pressure), was used in Venue B. All microphones within a set were the same make and model. The general placement of the microphone for the venues is described in Annex A, Microphone Locations.

Each measurement microphone was calibrated to read 94 dB SPL on the analyzers using a Bruel & Kjaer[®] 4230 Portable Microphone Calibrator that was calibrated by Odin Metrology. The signal from each microphone calibration test was recorded into Pro Tools as well.

7.1.2 Measurement Platforms

The bench-testing subgroup 'laboratory-tested' modern acoustic analyzers and technologies in theatres of various sizes and seating configurations. The tests showed that different manufacturers' systems yield essentially identical results when subjected to the same test conditions. This validated the hypothesis that the technology's measurements are not dependent on a specific test-system design.

7.1.3 Room Set-Ups

Annex A shows the set ups in the rooms.

- In the commercial and reference theatres, the far-field microphones were generally located as per the layout specified in SMPTE ST 202. The reference microphone location was 2/3 of the distance back from the screen along the longitudinal centerline.
- For the dubbing stages, the microphones were located in the area behind the mixing console in front of the "producers" desk, and along a transverse line. The reference microphone was at the main mix position, and the other microphones were distributed around the area described in order to obtain spatial averaging.
- The height of the microphones was varied as the testing proceeded. The baseline testing had the room microphones approximating ear level at the seats. Later testing raised the microphones to 1.42 m (56") in order to test if this would eliminate the common "seat dip". This has not been considered in this report due to time constraints.

7.2 Test Signals and Data Recording

7.2.1 Signal Sources

The test signals were played from the same Pro Tools[®] workstation that recorded the data.

- The pink noise signal used in Venues A, B, C, D and F was from the TMH test CD, which was a 44.1 kHz 16 bit stream that was converted to 48 kHz, 24 bit and inserted into Pro Tools[®] for playback.

- The pink noise signal used in Venues E was supplied by Meyer Sound[®] which was a 48 kHz, 24 bit native resolution.
- In Venue E, a 15 s exponential sine-sweep (chirp) signal was also used for comparison. Each test was performed with both the Meyer Pink Noise and the exponential sine-sweep.
- A Dolby[®] DMU pink noise sample was in the Pro Tools[®] and referenced at each testing session, but was not used for any of the measurements.

7.2.2 Signal Flow

Annex B provides a drawing of the signal flow used in the testing.

7.2.3 Recording devices and settings

At each venue, two or more analyzers from different manufacturers were employed that displayed the data in real time, which provided the means to both verify the tests and facilitate real-time B-chain calibration changes. Data from these analyzers was saved by the operators. In addition, all data was recorded into a Pro Tools workstation for later analysis. Both the source signal and microphone signals were fed simultaneously to the analyzers and the Pro Tools recording system. The Pro Tools data is utilized in this report except where noted. Annex B shows the block diagram of the equipment set up and signal flow.

7.2.4 Real time analyzers used and (basic) settings for each

The following real time analyzers were employed during the testing. Note that not all were used for every venue, but a minimum of two were utilized at each venue. Each analyzer received the source signal and inputs from each microphone. This measurement data was not used for this report.

- SMAART, Multi-Channel Sound System Measurement, Optimization and Control Software, Rational Acoustics
- SIM-3, Audio Analyzer System, Meyer Sound Laboratories, Inc
- AFMG Systune, Live Sound Measurements in Real Time! Software, Ahnert Feistel Media Group[®]
- D2, Acoustical Measurement System, AcoustX[®]

7.2.5 Pro Tools/BWF recording and settings

The Pro Tools workstation was configured to play the source signal and to record the source signal and each microphone.

- Sampling Rate = 48 kHz
- Bit Depth = 24 bits
- Audio File Format = Broadcast Wave (.WAV)

7.3 Matrix of Tests and Results

Table 2 shows a comprehensive matrix of all the measurements that have been presented in this report.



Table 2 Reference table of measurements

Figure No	Average and/or Reference	10 ms	50 ms	48 PPO	2 sec	Multiple position Or Range	Tree Mics	C	L	R	Surround						LFE	X-Curve	EQ In	EQ Out	IR	Schroeder Decay	RT	Cum'tve Energy
											5.1	7.1	L-S	R-S	L-R	R-R								
FIG 14	Cin A	Ref		x				x	x	x								x						
	Cin B	Ref		x				x	x	x								x						
	Cin C	Ref		x				x	x	x								x						
	Cin D	Ref		x				x	x	x								x						
	Dub E	Ref		x				x	x	x								x						
	Dub F	Ref		x				x	x	x								x						
FIG 15	Cin A	Ref			x			x									x	x	x					
	Cin B	Ref			x			x									x	x	x					
	Cin C	Ref			x			x									x	x						
	Cin D	Ref			x			x									x	x						
	Dub E	Ref			x			x									x	x	x					
	Dub F	Ref			x			x									x	x	x					
FIG 16	Cin A	Avg/Ref			x	Multiple											x		x					
	Cin B	Avg/Ref			x	Multiple											x		x					
	Cin C	Avg/Ref			x	Multiple											x		x					
	Cin D	Avg/Ref			x	Multiple											x		x					
	Dub E	Avg/Ref			x	Multiple											x		x					
	Dub F	Avg/Ref			x	Multiple											x		x					
FIG 17	Cin A	Ref			x	Range											x		x					
	Cin B	Ref			x	Range											x		x					
	Cin C	Ref			x	Range											x		x					
	Cin D	Ref			x	Range											x		x					
	Dub E	Ref			x	Range											x		x					
	Dub F	Ref			x	Range											x		x					
FIG 18	Cin A	Average			x	Range											x		x					
	Cin B	Average			x	Range											x		x					
	Cin C	Average			x	Range											x		x					



Figure No	Average and/or Reference	10 ms	50 ms	48 PPO	2 sec	Multiple position Or Range	Tree Mics	C	L	R	Surround						LFE	X-Curve	EQ In	EQ Out	IR	Schroeder Decay	RT	Cum'tve Energy
											5.1	7.1	L-S	R-S	L-R	R-R								
	Cin D	Average			x	Range										x		x						
	Dub E	Average			x	Range										x		x						
	Dub F	Average			x	Range										x		x						
FIG 19	Cin A	Avg/Ref		x		Multiple					x		x					x						
	Cin B	Avg/Ref		x		Multiple						x	x		x			x						
	Cin C	Avg/Ref		x		Multiple							x					x						
	Cin D	Avg/Ref		x		Multiple							x					x						
	Dub E	Avg/Ref		x		Multiple							x					x						
	Dub F	Avg/Ref		x		Multiple							x					x						
FIG 20	Cin A	Acoustic																			x			
	Cin B	Acoustic																			x			
	Cin C	Acoustic																			x			
	Cin D	Acoustic																			x			
	Dub E	Acoustic																			x			
	Dub F	Acoustic																			x			
FIG 21	Cin A	Acoustic						x																x
	Cin B	Acoustic						x																x
	Cin C	Acoustic						x																x
	Cin D	Acoustic						x																x
	Dub E	Acoustic						x																x
	Dub F	Acoustic						x																x
FIG 22	Cin A	Ref						x										x				x		
	Cin B	Ref						x										x				x		
	Cin C	Ref						x										x				x		
	Cin D	Ref						x										x				x		
	Dub E	Ref						x										x				x		
	Dub F	Ref						x										x				x		



Figure No	Average and/or Reference	10 ms	50 ms	48 PPO	2 sec	Multiple position Or Range	Tree Mics	C	L	R	Surround						LFE	X-Curve	EQ In	EQ Out	IR	Schroeder Decay	RT	Cum'tve Energy
											5.1	7.1	L-S	R-S	L-R	R-R								
FIG 23	Cin A	Ref						x										x						x
	Cin B	Ref						x										x						x
	Cin C	Ref						x										x						x
	Cin D	Ref						x										x						x
FIG 24	Dub E	Ref						x										x						x
	Dub F	Ref						x										x						x
FIG 25	Cin A	Avg/Ref			x		Range	x										x						
	Cin B	Avg/Ref			x		Range	x										x						
	Cin C	Avg/Ref			x		Range	x										x						
	Cin D	Avg/Ref			x		Range	x										x						
FIG 26	Dub E	Avg/Ref			x		Range	x										x						
	Dub F	Avg/Ref			x		Range	x										x						
FIG 27	Cin A	Avg/Ref			x		Range		x									x						
	Cin B	Avg/Ref			x		Range		x									x						
	Cin C	Avg/Ref			x		Range		x									x						
	Cin D	Avg/Ref			x		Range		x									x						
FIG 28	Dub E	Avg/Ref			x		Range		x									x						
	Dub F	Avg/Ref			x		Range		x									x						
FIG 29	Cin A	Avg/Ref			x		Range			x								x						
	Cin B	Avg/Ref			x		Range			x								x						
	Cin C	Avg/Ref			x		Range			x								x						
	Cin D	Avg/Ref			x		Range			x								x						
FIG 30	Dub E	Avg/Ref			x		Range			x								x						
	Dub F	Avg/Ref			x		Range			x								x						
FIG 31	Cin A	Avg/Ref			x		Range										x		x					
	Cin B	Avg/Ref			x		Range										x		x					
	Cin C	Avg/Ref			x		Range										x		x					
	Cin D	Avg/Ref			x		Range										x		x					



Figure No	Average and/or Reference	10 ms	50 ms	48 PPO	2 sec	Multiple position Or Range	Tree Mics	C	L	R	Surround						LFE	X-Curve	EQ In	EQ Out	IR	Schroeder Decay	RT	Cum'tve Energy	
											5.1	7.1	L-S	R-S	L-R	R-R									
FIG 32	Dub E	Avg/Ref			x		Range										x		x						
	Dub F	Avg/Ref			x		Range										x		x						
FIG 33	Cin A	Avg/Ref			x		Range												x						
	Cin B	Avg/Ref			x		Range												x						
	Cin C	Avg/Ref			x		Range												x						
	Cin D	Avg/Ref			x		Range												x						
FIG 34	Dub E	Avg/Ref			x		Range												x						
	Dub F	Avg/Ref			x		Range												x						
FIG 35	Cin A					x		x												x					
	Dub E					x		x													x				
	Dub F					x		x													x				
A1	Cin A	Ref		x	x	x	Range		x											x					
A2	Cin A	Average		x	x	x	Range		x											x					
A3	Cin A	Ref			x			x	x											x					
A4	Cin A	Average			x			x	x											x					
A5	Cin A	Ref	x	x	x	x			x											x					
A6	Cin A	Ref				x			x										x	x	x				
A7-A	Cin A	Ref		x					x	x	x									x					
A7-B	Cin A	Ref			x				x	x	x									x					
A7-C	Cin A	Ref				x			x	x	x									x					
A7-D	Cin A	Ref			x		Range		x	x	x														
A8-A	Cin A	Average		x					x	x	x														
A8-B	Cin A	Average			x				x	x	x														
A8-C	Cin A	Average				x			x	x	x														
A9	Cin A	Ref				x	Range												x		x				
A10	Cin A	Average				x	Range													x		x			
A11	Cin A	Avg/Ref				x	Multiple													x		x			



Figure No	Average and/or Reference	10 ms	50 ms	48 PPO	2 sec	Multiple position Or Range	Tree Mics	C	L	R	Surround						LFE	X-Curve	EQ In	EQ Out	IR	Schroeder Decay	RT	Cum'tve Energy
											5.1	7.1	L-S	R-S	L-R	R-R								
A12	Cin A	Average				x											x		x	x				
A13	Cin A						No Response Available																	
A14	Cin A	Avg/Ref			x		Multiple												x					
A15	Cin A	Ref			x		Range												x					
A16	Cin A						No Response Available																	
A17	Cin A	Acoustic						x													x			
A18	Cin A	Acoustic						x														x		
A19	Cin A	Acoustic						x															x	
A20	Cin A	Acoustic						x																x
B1	Cin B	Ref		x	x	x	Range		x										x					
B2	Cin B	Average		x	x	x	Range		x										x					
B3	Cin B	Avg/Ref			x		Multiple		x										x					
B4	Cin B	Avg/Ref			x	x	Mult/Clo s		x															
B5	Cin B						No Response Available																	
B6	Cin B	Ref	x	x	x	x			x											x				
B7	Cin B	Ref				x			x									x	x	x				
B8-A	Cin B	Ref		x					x	x	x									x				
B8-B	Cin B	Ref			x				x	x	x									x				
B8-C	Cin B	Ref				x			x	x	x									x				
B8-D	Cin B				x		Range		x	x	x									x				
B9-A	Cin B	Average		x					x	x	x									x				
B9-B	Cin B	Average			x				x	x	x									x				
B9-C	Cin B	Average				x			x	x	x									x				
B10	Cin B	Ref				x	Range											x		x				
B11	Cin B	Average				x	Range												x		x			
B12	Cin B	Avg/Ref				x	Multiple													x		x		
B13	Cin B						No Response Available																	



Figure No	Average and/or Reference	10 ms	50 ms	48 PPO	2 sec	Multiple position Or Range	Tree Mics	C	L	R	Surround						LFE	X-Curve	EQ In	EQ Out	IR	Schroeder Decay	RT	Cum'tve Energy										
											5.1	7.1	L-S	R-S	L-R	R-R																		
B14.5	Cin B	Ref		x							x		x	x																				
B14.7	Cin B	Ref		x								x	x	x	x	x																		
B15.5	Cin B	Average		x							x		x	x																				
B15.7	Cin B	Average		x		Multiple						x	x	x	x	x																		
B16	Cin B	Avg/Ref		x		Multiple						x																						
B17	Cin B	Avg/Ref		x		Multiple							x																					
B18	Cin B	Avg/Ref		x		Multiple						x																						
B19	Cin B	Avg/Ref		x		Multiple							x																					
B20	Cin B	Avg/Ref		x		Multiple								x																				
B21	Cin B	Avg/Ref		x		Multiple									x																			
B22	Cin B	Acoustic						x										x			x													
B23	Cin B	Acoustic						x										x				x												
B24	Cin B	Acoustic						x										x					x											
B25	Cin B	Acoustic						x										x							x									
C1	Cin C	Ref		x	x	x	Range		x											x														
C2	Cin C	Average		x	x	x	Range		x											x														
C3	Cin C	Avg/Ref			x		Multiple		x											x														
C4	Cin C							No Response Available																										
C5	Cin C							No Response Available																										
C6	Cin C	Ref	x	x	x	x	Multiple		x											x														
C7	Cin C	Ref				x			x										x	x														
C8-A	Cin C	Ref		x					x	x	x									x														
C8-B	Cin C	Ref			x				x	x	x									x														
C8-C	Cin C	Ref				x			x	x	x									x														
C8-D	Cin C				x		Range		x	x	x									x														
C9-A	Cin C	Average		x					x	x	x									x														
C9-B	Cin C	Average			x				x	x	x									x														



Figure No	Average and/or Reference	10 ms	50 ms	48 PPO	2 sec	Multiple position Or Range	Tree Mics	C	L	R	Surround						LFE	X-Curve	EQ In	EQ Out	IR	Schroeder Decay	RT	Cum'tve Energy				
											5.1	7.1	L-S	R-S	L-R	R-R												
C9-C	Cin C	Average			x			x	x	x								x										
C10	Cin C	Ref			x	Range											x		x									
C11	Cin C	Average			x	Range											x		x									
C12	Cin C	Avg/Ref			x	Multiple											x		x									
C13	Cin C						No Response Available																					
C14	Cin C	Ref			x																							
C15	Cin C	Average			x																							
C16	Cin C	Avg/Ref			x	Multiple																						
C17	Cin C	Avg/Ref			x	Multiple																						
C18	Cin C						No Response Available																					
C19	Cin C						No Response Available																					
C20	Cin C						No Response Available																					
C21	Cin C						No Response Available																					
C22	Cin C	Acoustic																						x				
C23	Cin C	Acoustic																							x			
C24	Cin C	Acoustic																							x			
C25	Cin C	Acoustic																							x			
D1	Cin D	Ref		x	x	x	Range		x																x			
D2	Cin D	Average		x	x	x	Range		x																x			
D3	Cin D	Avg/Ref			x		Multiple		x																x			
D4	Cin D						No Response Available																					
D5	Cin D						No Response Available																					
D6	Cin D		x	x	x	x			x																x			
D7	Cin D					x			x																x			
D8-A	Cin D	Ref		x					x	x	x														x			
D8-B	Cin D	Ref			x				x	x	x														x			
D8-C	Cin D	Ref				x			x	x	x														x			



Figure No	Average and/or Reference	10 ms	50 ms	48 PPO	2 sec	Multiple position Or Range	Tree Mics	C	L	R	Surround						LFE	X-Curve	EQ In	EQ Out	IR	Schroeder Decay	RT	Cum'tve Energy	
											5.1	7.1	L-S	R-S	L-R	R-R									
D8-D	Cin D	Ref		x		Range		x	x	x								x							
D9-A	Cin D	Average		x				x	x	x								x							
D9-B	Cin D	Average			x			x	x	x								x							
D9-C	Cin D	Average				x		x	x	x								x							
D10	Cin D	Ref				x	Range										x		x						
D11	Cin D	Average				x	Range										x		x						
D12	Cin D	Avg/Ref				x	Multiple										x		x						
D13	Cin D						No Response Available																		
D14	Cin D	Ref			x								x	x	x	x	x								
D15	Cin D	Average			x								x	x	x	x	x								
D16	Cin D	Avg/Ref			x		Multiple							x											
D17	Cin D	Avg/Ref			x		Multiple								x										
D18	Cin D	Avg/Ref			x		Multiple									x									
D19	Cin D	Avg/Ref			x		Multiple									x									
D20	Cin D	Acoustic																				x			
D21	Cin D	Acoustic																					x		
D22	Cin D	Acoustic																						x	
D23	Cin D	Acoustic																							x
E1	Dub E	Ref		x	x	x	Range	x	x										x						
E2	Dub E	Average		x	x	x	Range	x	x										x						
E3	Dub E	Avg/Ref			x		Multiple	x	x										x						
E4	Dub E	Ref			x			x	x										x						
E5	Dub E	Average			x			x	x										x						
E6	Dub E	Ref	x	x	x	x		x											x						
E7	Dub E	Ref				x		x											x	x	x				
E8-A	Dub E	Ref		x				x	x	x									x						
E8-B	Dub E	Ref			x			x	x	x									x						
E8-C	Dub E	Ref				x		x	x	x									x						



Figure No	Average and/or Reference	10 ms	50 ms	48 PPO	2 sec	Multiple position Or Range	Tree Mics	C	L	R	Surround						LFE	X-Curve	EQ In	EQ Out	IR	Schroeder Decay	RT	Cum'tve Energy
											5.1	7.1	L-S	R-S	L-R	R-R								
E8-D	Dub E			x		Range		x	x	x								x						
E9-A	Dub E	Average	x					x	x	x								x						
E9-B	Dub E	Average		x				x	x	x								x						
E9-C	Dub E	Average			x			x	x	x								x						
E10	Dub E	Ref			x	Range										x		x						
E11	Dub E	Average			x	Range										x		x						
E12	Dub E	Avg/Ref			x	Multiple										x		x						
E13	Dub E	Average			x											x		x	x					
E14	Dub E	Ref		x								x	x		x			x						
E15	Dub E	Average		x								x	x		x			x						
E16	Dub E	Avg/Ref			x	Multiple							x					x						
E17	Dub E	Avg/Ref			x	Multiple								x				x						
E18	Dub E	Avg/Ref			x	Multiple							x		x			x						
E19	Dub E	Acoustic																			x			
E20	Dub E	Acoustic																				x		
E21	Dub E	Acoustic																					x	
E22	Dub E	Acoustic																						x
F1	Dub F	Ref		x	x	x	Range		x											x				
F2	Dub F	Average		x	x	x	Range		x											x				
F3	Dub F	Avg/Ref			x		Multiple		x											x				
F4	Dub F	Ref			x			x	x											x				
F5	Dub F	Average			x			x	x											x				
F6	Dub F	Ref	x	x	x	x			x											x				
F7	Dub F	Ref				x			x										x	x	x			
F8-A	Dub F	Ref		x					x	x	x									x				
F8-B	Dub F	Ref			x				x	x	x									x				
F8-C	Dub F	Ref				x			x	x	x									x				
F8-D	Dub F	Ref			x		Range		x	x	x									x				



Figure No	Average and/or Reference	10 ms	50 ms	48 PPO	2 sec	Multiple position Or Range	Tree Mics	C	L	R	Surround						LFE	X-Curve	EQ In	EQ Out	IR	Schroeder Decay	RT	Cum'tve Energy
											5.1	7.1	L-S	R-S	L-R	R-R								
F9-A	Dub F	Average	x					x	x	x								x						
F9-B	Dub F	Average		x				x	x	x								x						
F9-C	Dub F	Average			x			x	x	x								x						
F10	Dub F	Ref			x	Range										x		x						
F11	Dub F	Average			x	Range										x		x						
F12	Dub F	Avg/Ref			x	Multiple										x		x						
F13	Dub F	Average			x											x		x	x					
F14	Dub F	Ref		x					x			x	x		x									
F15	Dub F	Average		x					x			x	x		x									
F16	Dub F	Avg/Ref		x		Multiple							x		x									
F17	Dub F	Avg/Ref		x		Multiple								x										
F18	Dub F	Avg/Ref		x										x										
F19	Dub F	Acoustic																			x			
F20	Dub F	Acoustic																				x		
F21	Dub F	Acoustic																					x	
F22	Dub F	Acoustic																						x



7.3.1 Reverberation time measurements

Reverberation times are presented in the sections giving the venue data.

7.3.2 System mechanical/status measurements

The testing procedures included tests for distortion and polarity, among others. As time was of the essence in testing sessions, few venues received these tests; therefore the data is not presented.

7.3.3 Effects of system equalization measurements

In most venues, the effects of the system equalization were measured as follows:

- “As Found” (Note that EQ settings were saved so they could be recalled)
- “System EQ bypassed” (Global system EQ bypassed, e.g. from the Cinema Processor)

All EQ settings were saved so they could be recalled both for comparison and to restore the system EQ after testing was complete.

In some venues, the group performed their own system equalization based on what was observed on the real time analyzers. These were used for listening purposes but are not presented in the report.

- “Group EQ Settings 1”-- EQ the group did to the system based on real time analysis
- “Group EQ Settings 2” (If time permitted)

7.3.4 Center channel measurements

The following was measured on the Center channel in most venues:

- The response from the room microphones
- The response from the close-field microphones located on a “tree” (Venues A, E and F)
- Venue B (reference theatre) used one microphone that was progressively moved around the center loudspeaker and then mathematically averaged.
- Effects of system equalization
- The room microphones and close-field measurements were recorded simultaneously

7.3.5 Other screen channels

The other screen channels were tested in the same manner as the Center if time permitted, using the room microphones only. The close-field microphones were not used for these measurements.

7.3.6 Surround Measurements

The following was measured on the Surrounds in most venues:

- Left Surround (Ls) in 5.1 mode
- Left Side Surround (Lss) in 7.1 mode
- Left Rear Surround (Lrs) in 7.1 mode
- Effects of system equalization (if time permitted)



The Right Surrounds were done in a similar fashion if time permitted.

The surrounds were measured using the room microphones only. The Mic Tree was not used for these measurements.

7.3.7 Subwoofer Measurements

The following was measured on the Subwoofer system in all venues:

- the response with all subwoofers on
- effects of system equalization in Venues A, E and F.

The subwoofers were measured using the room microphones only. The close-field microphones were not used for these measurements.

7.3.8 Close-field setups

- In Venues A, E and F, a three-microphone system (dubbed “Mic Tree”) was placed close to the screen Center-channel loudspeaker, to i) allow the usefulness of responses at this position to be assessed and ii) for comparison with responses at the microphones located in the seating area or at the mixing console.
- The tree microphones were located 3 to 5 meters from the screen depending on the loudspeaker arrangement. The microphones were placed vertically, approximately 1 meter apart, at a height such that the top microphone lined up with the high frequency driver
- In the reference cinema, the close-field response of the center loudspeaker was measured using a single microphone that was moved around the center loudspeaker cabinet area in 7 positions. Mathematical averaging of the data from each position was undertaken to obtain the spatial average response of the center loudspeaker system.
- Inspection of the responses at the microphone position 2/3 back from the screen indicates that the presence of the microphone tree in front of the center loudspeaker had negligible impact on the measured response in the listening area.
- True near-field measurements are made much closer to the loudspeakers than the distance of the tree, and as such the term “close-field” is used to differentiate these “close” measurements from measurements made in the seating area.

7.4 Listening

A Pro Tools session was created for the listening tests using a sequence of excerpts from various movies that featured dialog, music or effects. Both quiet scenes and action scenes were represented. The session also contained non-movie material, such as voice and orchestral music.

The group listened to this material with the system equalization “as found”, “bypassed”, and also with Group EQ Settings 1 and Group EQ Settings 2 if these were done at the specific venue. At all venues, a minimum of one clip was heard in all EQ modes, and if time permitted, the entire sequence.

The group took informal notes and shared impressions at each venue. Unfortunately, time did not permit extensive analysis and comparisons as had been planned, so no listening data is presented in this report. However, the group did have significant agreement on what they heard and the audible effects of adjustment of the system equalization.



Research by Toole and others shows that it is possible to extrapolate subjective performance of loudspeaker systems from frequency response data presented, as long as the parameters of the test regime are known. Those experienced with these audio-testing systems will be able to extrapolate the subjective performance of these systems from the frequency response data presented.

8 FOUNDATION FOR THE DATA PROCESSING AND ANALYSIS

In (13Error! Reference source not found.) Holman discusses a range of topics that are pertinent to i) the processing and analysis work described in this section, and ii) the results presented in later sections. That report will provide readers with useful background information.

8.1 Linearity

Based on the assumption that the loudspeaker systems (crossover, amplifier, and loudspeaker) add little distortion to the signal, they can be regarded as linear systems within the range of the levels employed in the testing. In this report, the systems are assumed to be linear if their total harmonic distortion is less than 3% (14).

In particular it is important that the test signal maintain the linear time invariant nature of the system, by avoiding aliasing and clipping.

8.2 Impulse Response

Any system that is linear and time-invariant is completely characterized by its impulse response (IR). That is, for any input, the output can be calculated in terms of the input signal and its impulse response.

The impulse response function of a system is the output that results when the system is presented with an ultra-short input signal called an impulse. The IR describes the reaction of the system to this impulse as a function of time. As the impulse function contains all frequencies, the impulse response defines the response of a linear time-invariant system for all frequencies.

Since the systems are linear, the IR of the loudspeaker/room system measured with a given source and microphone position contains all the information necessary to assess the frequency response and temporal behavior of the B-chain and room acoustics.

As the impulse signal contains all frequencies, the IR defines the response of a linear time-invariant system for all frequencies.

The frequency response transfer function, often known simply as the transfer function, is the ratio of the output signal to the input signal in the frequency domain. The transfer function is also the Laplace transform of the impulse response. Note that the well-known Fourier Transform is a subset of the more general Laplace Transform.

The Laplace Transform of a system's output in the frequency domain can be determined by the multiplication of the transfer function with the Laplace Transform of the input signal in the complex frequency plane. (The complex frequency plane is the complete description of the frequency domain). An inverse Laplace transform of this result will yield the output in the time domain.

When measuring electro-acoustic systems, it is often more useful to use signals in the frequency domain to yield frequency response transfer functions as opposed to the use of signals in the time domain, such as impulse signal. The benefits of this approach include increased signal to noise ratios in the measurements as

well as avoiding clipping in the electronic signal chain and reducing potential strain and damage to the loudspeaker drivers.

To determine an output directly in the time domain requires the convolution of the input with the impulse response. When the transfer function and the Laplace transform of the input are known, this convolution may be more complicated than the alternative of multiplying two functions in the frequency domain.

The impulse response can be viewed on a decibel scale by computing the term $20 \cdot \log_{10}(\text{abs}[v(t)])$, where $v(t)$ is the instantaneous voltage at any point in time. Note that the resulting plot is not the same as an Energy Time curve (ETC), as the ETC uses both the real and imaginary terms in the impulse response.

Figure 1 shows an example of the impulse response expressed logarithmically for the frequency range 500 Hz to 4 kHz.

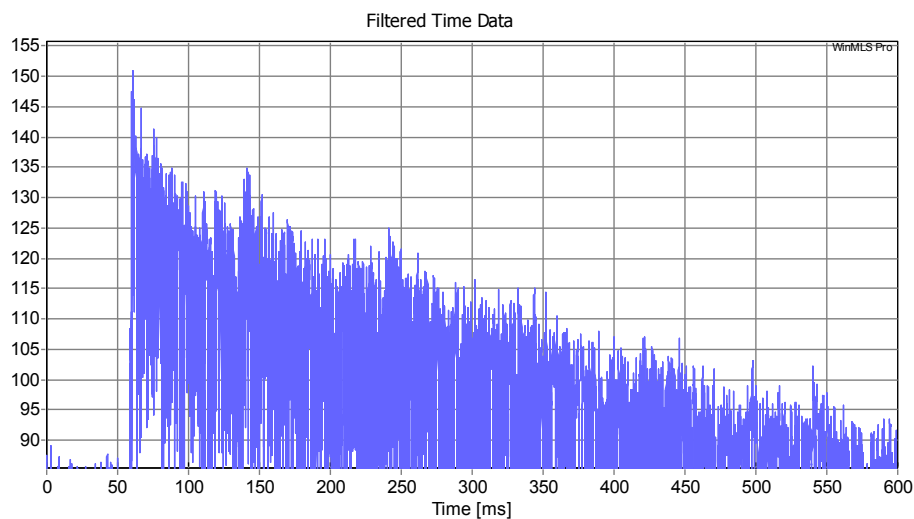

Figure 1 - Example of impulse response expressed in dB over frequency range 500 Hz to 4 kHz.

8.3 Computation of Impulse Responses

For this work, the impulse responses were extracted from the pink noise recordings at the microphones by a deconvolution process that cross-correlated each recording with the source (dry) pink noise signal. The deconvolution process was undertaken in a batch operation using MATLAB® 2012, which yielded the impulse responses for all the measurements for further processing and archiving. Densil Cabrera of Sydney University kindly supplied the deconvolution algorithm, which is used in their measurement software AARAE (18). This code is reproduced in Annex C.

Two lessons were learned during the process of deconvolving the pink files:

- a) It was discovered that not all deconvolution algorithms were suitable for the pink noise .WAV files recorded at each venue.

The problems that were encountered relate to the ability of the algorithm to cope with missing spectral content at high frequencies in the re-recorded pink noise due to the lower bandwidth of the re-recorded signal compared to the bandwidth of the microphone signal. This mismatch of bandwidth resulted in very high apparent gain at these high frequencies and produced a high amount of noise in the impulse response.



In this context, the bandwidth of the test signal should not be less than the bandwidth of the received signal, otherwise errors will occur. Note that this also applies to low frequencies.

- b) The TMH pink noise signal (used for nearly all venues) was originally sampled at 44.1 kHz and was converted to 48 kHz for the testing. This sample rate conversion resulted in the noise signal not having the true high frequency audio content of a 24 kHz sampled signal, which is required by the deconvolution algorithm to deal with the received noise floor of the system in this frequency region.

From the impulse responses, the frequency responses, the reverberation times and cumulative energy plots were computed.

8.4 Computation of Frequency Response

Time windows with a range of lengths were then applied to the impulse responses and their associated frequency responses were computed using the Fast Fourier Transform. MATLAB[®] 2012 was used for all windowing and frequency response calculations. The response data was exported to Excel for manipulation to produce the graphs. To prevent errors from creeping in due to “copy and paste” operations, all exporting and manipulation was conducted under macro control and formulae that addressed named ranges of data.

8.5 Time Windowing for Analysis

When the frequency content of a steady state signal is computed using the Fourier Transform, a Time Window must be applied to the signal to reduce the errors in the response due the Fourier Transform “chopping” through the beginning and end of the signal. These errors due to truncation are called spectral leakage.

Time windows are multiplied with the signal, and consist of a middle section that contains the signal, and start and stop sections that force the signal to zero value. Generally, the start and stop sections are tapered so the signal is gradually forced to zero value, rather than a rapid step.

With transient signals such as an impulse response, the time window has two functions:

1. A specific section of the impulse can be selected for analysis.
2. The parts of the signal that lie outside the selected section can be gradually forced to zero to minimize the effects of spectral leakage.

Time windowing is an integral part of deriving the frequency response from the impulse response using the Fourier Transform.

Time windows that have been used in the data analysis are described later in this Section. For further information on the use of signal processing in time-windows, the reader is directed to references (15) and (16).

8.5.1 Window Length

The theoretical low frequency cutoff for a time window of T seconds is $1/T$ Hz, which means that the lower limits of a 10 ms and 50 ms window would be 100 Hz and 20 Hz respectively. However, the frequency resolution is also $1/T$ Hz and therefore with these windows narrow-band audible effects and resonances can only be seen above a few hundred Hertz. At frequencies below approximately $4/T$, (80 Hz for the 50 ms window), the limited resolution means that the response is only useful in a broadband, and low-Q sense.

It is also noted that the group delay and non-minimum phase effects in loudspeakers can result in their impulse response lengths exceeding 10 ms, and therefore a 10 ms window cannot capture their entire free-field impulse response. However in a true anechoic environment, a 50 ms window is likely to capture the response down to 100 Hz.

Five window lengths are used in the analyses, which are listed in in Table 3.

Table 3 Time-window durations used for the analysis.

Window Duration	Rationale behind its use
10 ms	Shows direct field and very early reflections accurately down to 400 Hz. In some situations with few early reflections and low group delay in the loudspeaker system, this frequency limit can be lower, while in others it can be as high as 500 Hz.
50 ms	50 ms is an approximation of the precedence effect interval for speech only.
24 PPO	The decreasing length of time window provides i) higher resolution measurements at low frequencies, ii) direct field plus early reflections at mid-range frequencies, and iii) direct field at high frequencies. The principal disadvantage of this time window is that its short duration of 2 ms at 10 kHz, can often exclude important high frequency direct field information, particularly if the high frequency sound arrives after the mid frequency sound.
48 PPO	Similar to 24 PPO, but has twice the length for high frequency direct field signals that arrive late relative to the first direct-field arrival.
2 s	Equivalent to the steady state response, with overall similarity to the response shown by a 1/3 rd octave real-time analysis. If the response was integrated into 1/3 rd octave bands, it would replicate the result shown by an RTA.

Note: PPO means points per octave

For transient sounds the precedence effect interval is much shorter than 50 ms; as low as 5 ms. For sustained sounds such as music, the interval is longer. The precedence effect also depends on the reverberation time of the room. Rakerd and Hartman in (12) conclude this effect can be up to 100 ms for pure tones. Olive and Toole (17) present results for music and movies.

8.5.2 Window Shape

The half Tukey window is regarded by the Data Report Group as the most suitable window for this application and consists of a rectangular section joined to a half-Hann window. Two reasons support this conclusion:

- The rectangular section retains the direct field data and the very early reflections. The standard half-Hann or similar type of window highly attenuates the direct field and very early time information with shorter window lengths as the tapering begins at the start time of the window.
- The tapered cosine tail of the Tukey window reduces spectral leakage during the process of truncating the signal.

The durations of the rectangular and cosine components in the three fixed-length windows are listed in Table 4. Figure 2 shows the shapes of the half Tukey windows described in Table 4.

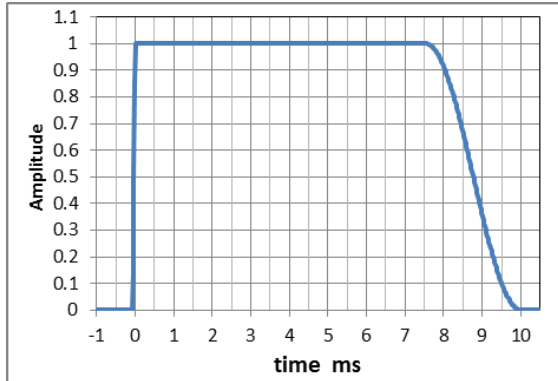

10 ms half Tukey window

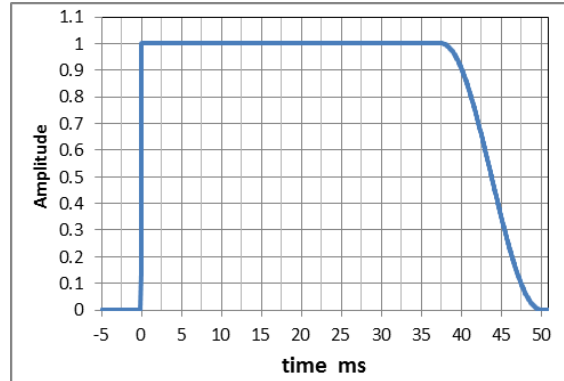

50 ms half Tukey window

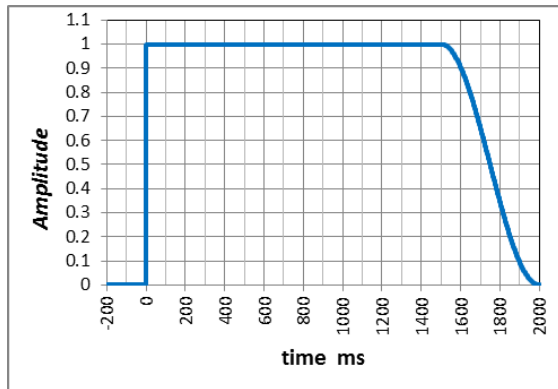

2 s half Tukey window

Note the change in time scale between the graphs

Figure 2 - Shapes of the fixed-length half Tukey windows with $\alpha=0.75$.

Table 4 Durations of rectangular and cosine components

Window	Rectangular section	Cosine section
10 ms	7.5 ms	2.5 ms
50 ms	37.5 ms	12.5 ms
2 s	1500 ms	500 ms

In the frequency response calculations, the rectangular portion of the half Tukey window is elongated by 2 ms, and the start time is automatically shifted to 2 ms before the peak of the impulse response. Thus, the impulse response is completely contained within the window, and the nominal window length is preserved.

8.5.3 Variable Length Windows (PPO)

When the number of data points in the frequency domain is fixed according to the specific octave frequency range, the FFT bin spacing becomes fixed in each octave, which in turn fixes the window duration. As the sample rate is fixed, the number of Discrete Fourier Transform (DFT) sample points changes according to the window duration. The nearest power of 2 to the DFT length is used as the FFT size.

Table 5 and Table 6 show the relationships between frequency resolution, window lengths and FFT sizes for 24 and 48 PPO processing. These relationships are the basis of the PPO algorithm.

The half Tukey window with $\alpha = 0.75$ is applied to each of the window durations listed in these tables, and are shown in right hand column in each table.

Table 5 24 PPO Relationships among frequency resolution, window durations and FFT sizes.

start	stop	octave no	DFT bin spacing (Hz)	window length assoc. with spacing (ms)	DFT points	nearest power of 2	FFT SIZE as power of 2 samples	time window size for FFT (ms)
10240	20480	10	426.7	2.3	112	7	128	2.67
5120	10240	9	213.3	4.7	225	8	256	5.33
2560	5120	8	106.7	9.4	450	9	512	10.67
1280	2560	7	53.3	18.8	900	10	1024	21.33
640	1280	6	26.7	37.5	1800	11	2048	42.67
320	640	5	13.3	75.0	3600	12	4096	85.33
160	320	4	6.7	150	7200	13	8192	170.67
80	160	3	3.3	300	14400	14	16384	341.33
40	80	2	1.7	600	28800	15	32768	682.67
20	40	1	0.8	1200	57600	16	65536	1365.33

Table 6 48 PPO Relationships among frequency resolution, window durations and FFT sizes

normalised octave band		octave no	DFT bin spacing (Hz)	window length assoc. with spacing (ms)	DFT points	Nearest power of 2	FFT size as Power of 2 samples	time window size for FFT (ms)
start	stop							
10240	20480	10	213.33	4.69	225	8	256	5.33
5120	10240	9	106.67	9.38	450	9	512	10.67
2560	5120	8	53.33	18.75	900	10	1024	21.33
1280	2560	7	26.67	37.5	1800	11	2048	42.67
640	1280	6	13.33	75.0	3600	12	4096	85.33
320	640	5	6.67	150	7200	13	8192	170.67
160	320	4	3.33	300	14400	14	16384	341.33
80	160	3	1.67	600	28800	15	32768	682.67
40	80	2	0.83	1200	57600	16	65536	1365.33
20	40	1	0.42	2400	115200	17	131072	2730.67

8.5.4 Graph Resolution

The display resolution of the frequency response graphs is $1/12^{\text{th}}$ octave, although the intrinsic resolution due to time-window length might be higher or lower.



8.6 Comparison of Real Time Analysis Method with Transfer Function Method

8.6.1 Steady state responses

The real time analyzer has no ability to determine the arrival-time of its signal, and as its integration time is long, it essentially measures the steady-state frequency response of a system.

Frequency responses derived from the IR are by definition, a transfer function, as the IR is the output signal with an impulse input signal. When the entire IR is used to calculate the frequency response, that response is equivalent to the steady state response of the system if the impulse response has fully decayed. The responses were computed using the method described above.

Some of the raw pink noise signals of the reference microphone were analyzed using an EASERA[®] SysTune Pro v1.3.5 real-time analyzer (RTA) and integrated into 1/12th octave bands. The entire recorded pink-noise segment was used for the analysis. There was no time constant on the measurement, and it simply an energy average. It should be noted that due to the stochastic nature of pink noise, the use of the entire segment would produce slightly different results than if shorter segments were used.

The RTA responses at the reference microphone were compared with the transfer function responses computed with a time window of 2 s, which is equivalent to the steady state for these rooms. The steady state and transfer function responses are shown in the following figures:

- Figure 3: center channel at Cinema A and Dubbing Stage E
- Figure 4: LFE channel at Cinemas A and C
- Figure 5: Left Surround at Cinemas A and C and Dubbing Stages E and F.

Although minor differences can be seen, the responses of the RTA and steady state IR methods are very similar. The differences with the IR method are due to the following factors.

- a) The inherent rejection of background noise provided by the cross-correlation method (used to compute the system's IR) is not present in the RTA spectrum analyzer, and therefore background noise can be revealed in RTA analyzers. This is often relevant at low frequencies with noise from HVAC systems.
- b) The RTA computes the energy in discrete bins of 1/12th octave wide, whereas the transfer function method uses a sliding 1/12th octave-wide window to produce a running average. This running average has the effect of slightly blurring the peaks and troughs in the response, whereas the RTA essentially locates the peaks in bins.
- c) The frequency response of the mixing console is included in the RTA response, but is not included in the transfer function method due to the recording of the test signal at the output of the console. If the console has a flat frequency response, this error is removed, however errors do occur, and the transfer function method helps to reduce them.

8.6.2 Benefits of IR Method

For computation of the frequency response, the impulse response method has a number of advantages over real-time analysis, which include:

- a) The measurement is intrinsically a transfer function and therefore imperfections in the test signal are inherently removed.
- b) Varying lengths of time data can be used for the response computation; ranging from short windows which allow a quasi-anechoic response to be derived, to long windows which include varying amounts of room reflections and reverberation. Using different window lengths, exploration can be made of the way



the response changes over time, which in turn provides insight into the factors underpinning the perceived tonality.

- c) The information gained from varying lengths of time data can be used to understand reasons for response anomalies.
- d) Unlike pink noise that is a stochastic signal, the impulse response is entirely repeatable, and therefore stable. This is particularly evident at frequencies below 50 Hz.
- e) Derivation of the impulse response from a test signal by cross-correlation provides some inherent rejection of background noise.
- f) An RTA response is never stable, particularly at low frequencies due to the random nature of the occurrence or otherwise of specific frequencies and levels.
- g) When viewing a RTA that is operating in real time or reading a streamed file, as distinct from loading a file whose length matches the FFT sample length of the analyzer, the time constant of the analyzer's display introduces uncertainty into the result. Often it is necessary to wait some 30 seconds for the display to settle to its steady state level.
- h) Strong echoes can be identified.
- i) As phase responses are available in an IR measurement, crossovers can be developed if needed.
- j) Polarity can be easily and reliably checked by careful examination of the first arrival of the impulse.
- k) The pink noise signal may have some spectral imperfections due to the filtering by the mixing console. The use of a dual-channel analyzer removes the effect of these imperfections.

Each of the above benefits is directly applicable to the cinema environment.

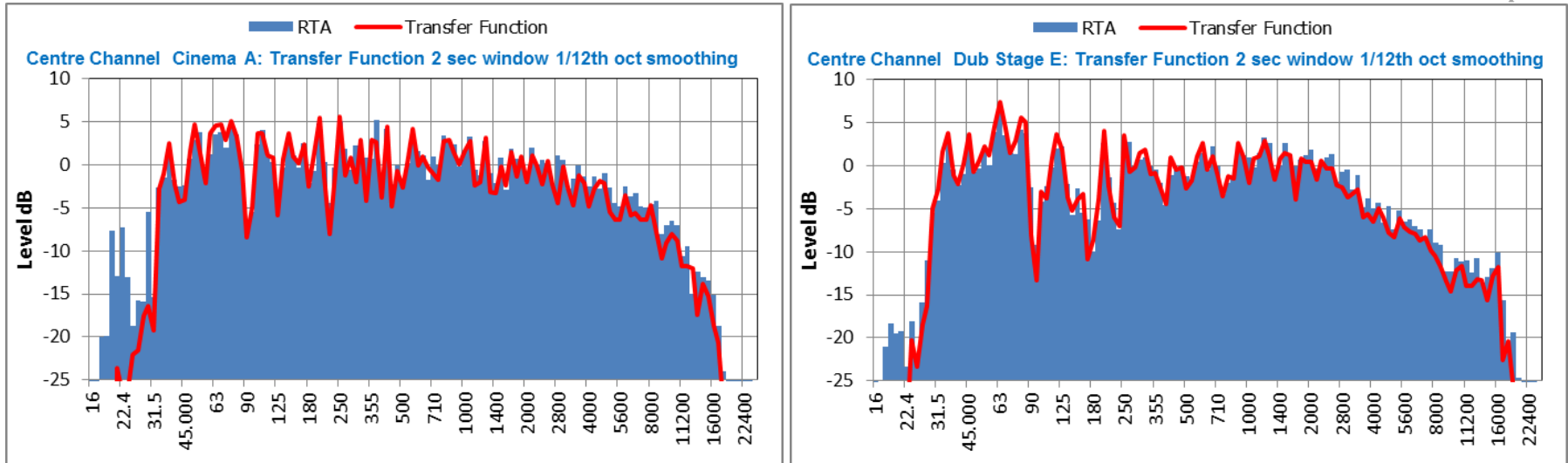

Figure 3 - Comparison of responses from RTA and transfer function of center channel at reference position for Cinema A and Dubbing Stage E

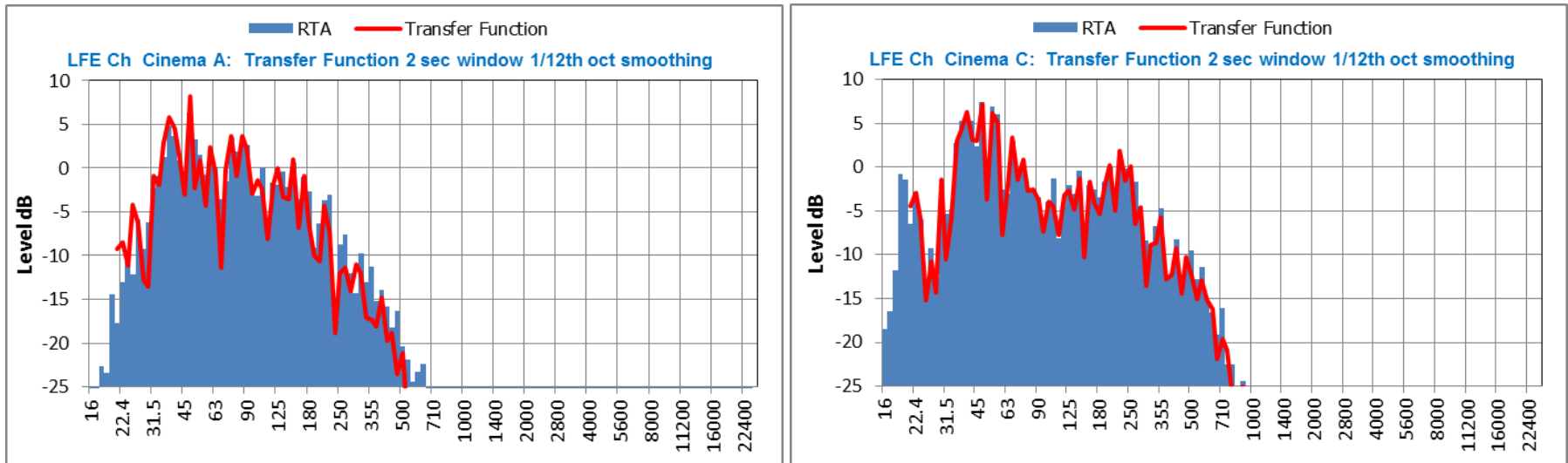

Figure 4 - Comparison of responses from RTA and transfer function of LFE channel at reference position for Cinema A and C

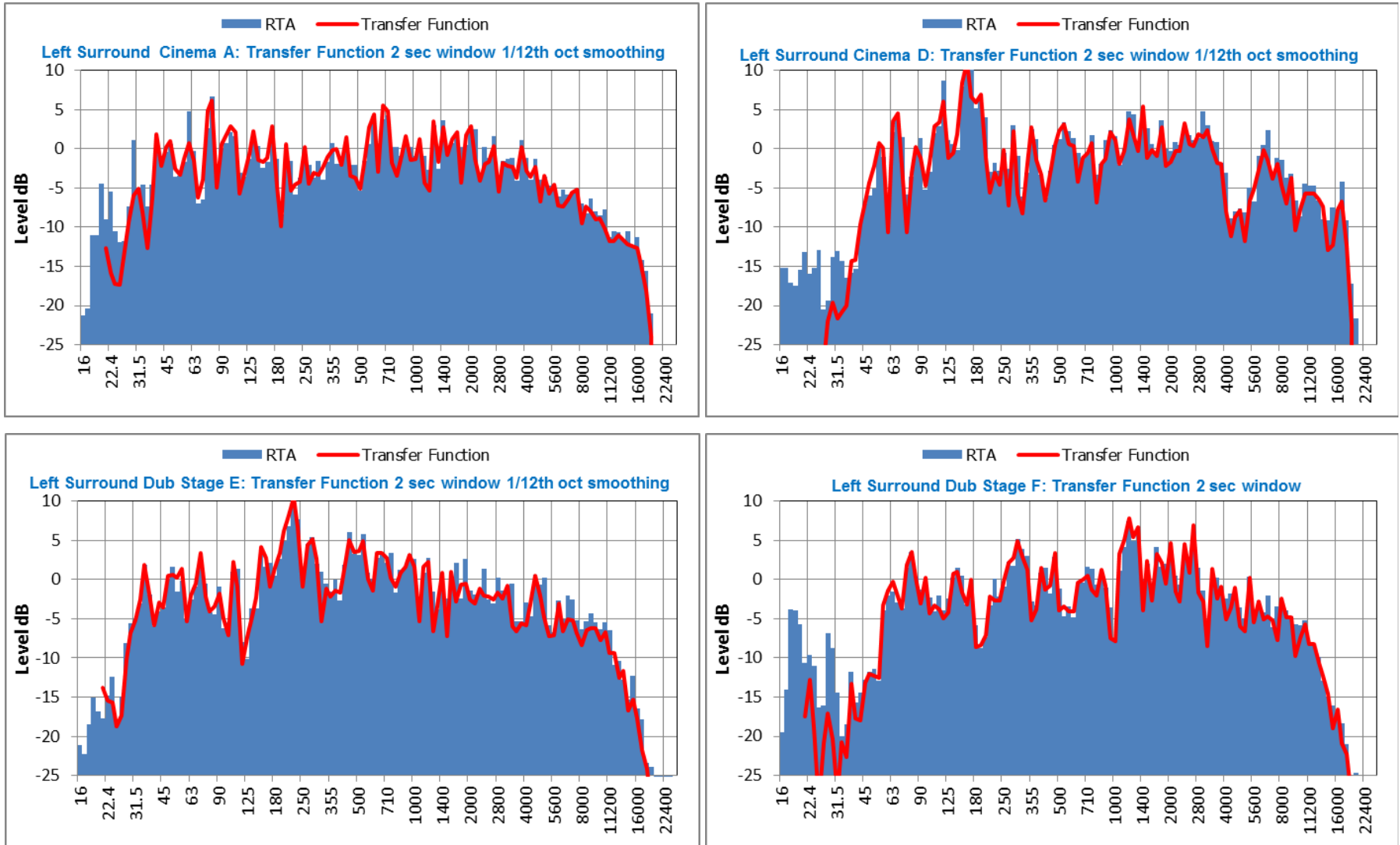

Figure 5 - Comparison of responses from RTA and transfer function of left surround channel at ref. pos. for Cinemas A and C and Dub Stages E and F.

8.7 Comparison of Pink Noise and Sine Sweep Test Signals

In addition to the pink noise test signal, a swept sine wave test signal was used at Dubbing Stage E. The sine sweep is used considerably in modern commercial electro-acoustic analyzers to provide the transfer function of the system under test. Further information is given in (21) and (22).

Compared to pink noise, there are a number of benefits of using a swept sine wave as the test stimulus. These include:

- a) The crest factor at each frequency is 3 dB, whereas the early versions the crest factor of pink noise is usually greater than 10 dB. This allows a higher signal to noise ratio to be produced by the loudspeaker at each frequency, rendering the measurement less sensitive to extraneous noise.
- b) When a swept sine signal is played in an environment with high background noise, the signal to noise ratio is much higher than if noise was played. In essence, all the power of the signal is concentrated at one frequency whereas the noise power is spread over the entire frequency range. An example is as follows. If in order to measure the impulse response of the room a 10 s long exponential swept-sine signal is played at 60 dB SPL level in a room that has an ambient (pink) noise level of 60 dB, the deconvolution process yields a signal to noise ratio of approximately 18 dB at each frequency.
- c) It is much easier to hear the effect of driver that is not working properly, or has a high degree of buzz or distortion.
- d) The room acoustic properties are much more audible and are heard as sounds that are not harmonically related to the instantaneous frequency of the sweep since the sweep has moved on to a different frequency by the time reflected/reverberant sound arrives.
- e) Harmonic distortion components become visible in the impulse response as pre or post echoes.

Like the pink noise tests, the sine sweep was recorded at the output of the mixing console and this signal forms the reference signal for the deconvolution process. Using the same deconvolution method described in Section 8.3, the impulse responses were computed for two channels from the swept sine recordings. The frequency responses were then computed from the impulse responses along with the responses associated with the pink noise impulse responses. The WinMLS 2004[®] analyzer was used for easy comparison and presentation of the impulse and frequency responses. A half-Blackman Harris window of arbitrary length 80 ms was used and the responses smoothed over a 1/24th octave bandwidth.

Figure 6 shows a section of the impulse responses of the Center channel at the reference microphone and the Lss channel at Mic 4 in Dubbing Stage E. Tiny differences are evident, which are likely to be due to either subtleties in the deconvolution algorithm and/or short-term variations in the room reflection pattern.

However, the frequency responses shown in Figure 7 are virtually identical, with extremely small differences being seen in the 5 kHz to 15 kHz region in the Center channel. These differences are most likely due to short-term variations in the room reflection pattern. The differences around 20 Hz in the Lss channel are due to the half-window chopping through low frequency noise in the impulse response.

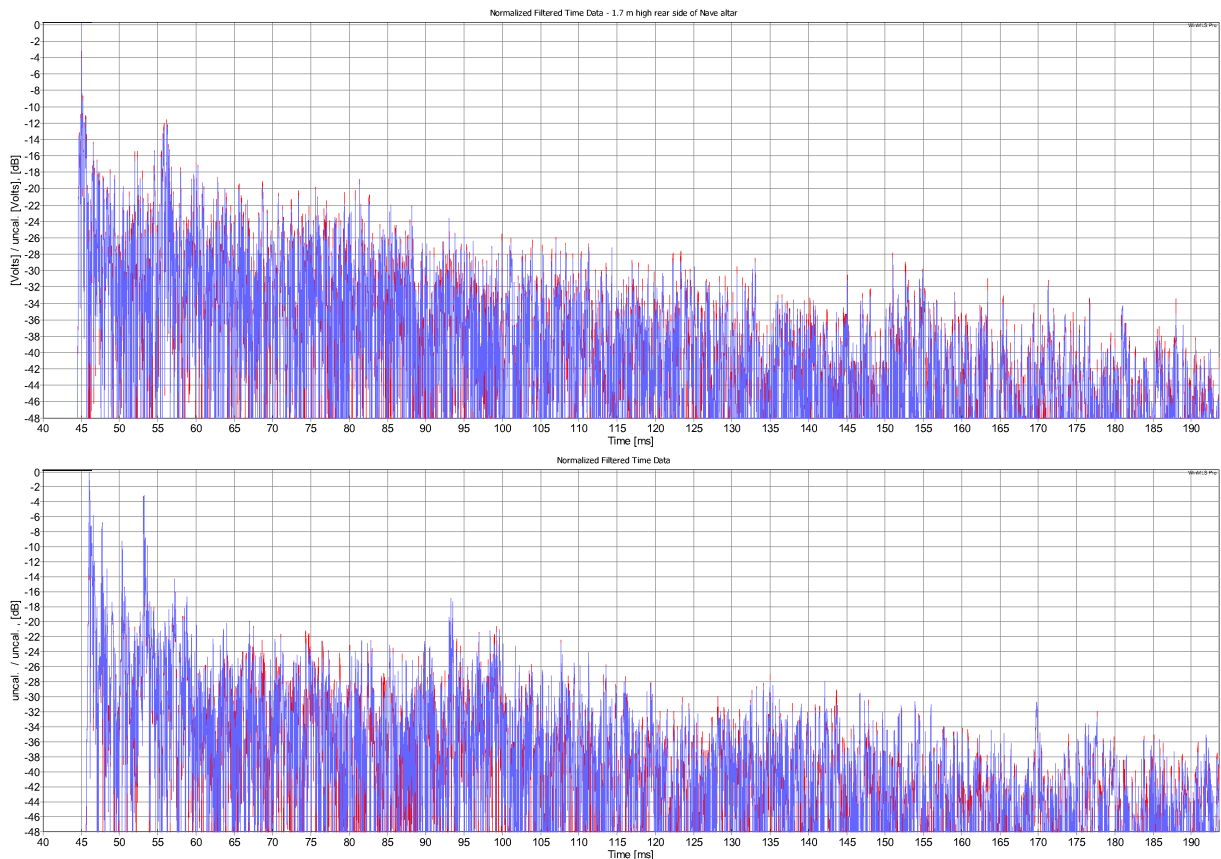

Figure 6 Sections of the impulse responses in log form of pink noise (blue) and swept sine wave (red) for Center Channel (upper) and Lss Channel (lower).

In summary, in perfect conditions, the swept sine test signal yields identical impulse responses (and associated frequency responses) to a pink noise test signal. But in the imperfect real world, there are numerous advantages of using a swept sine, which relate to signal to noise ratio and the ability to hear problems and artifacts with the sound system and room.

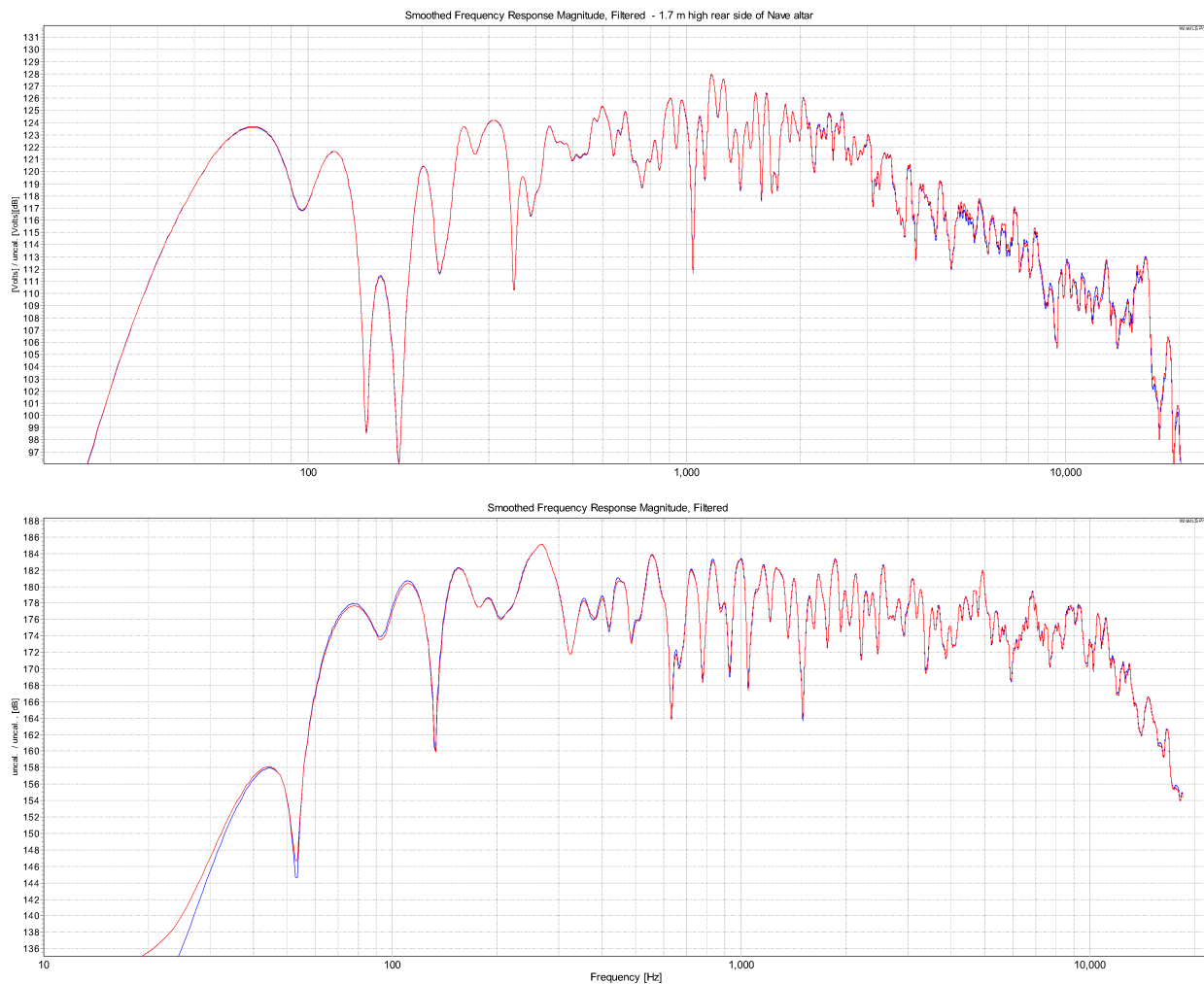

Figure 7 - Frequency responses obtained with swept sine wave (red) and pink noise (blue) of Center channel (upper) and Lss channel (lower)

9 PROCESSING OF TEMPORAL RESPONSES

9.1 Reverberation Time

The impulse response of a room/loudspeaker system contains all the necessary information to completely describe the temporal behavior of that system. It is important to note that when the impulse response is measured using an omnidirectional microphone, the sound arrives at the microphone from all directions. In this respect the impulse response differs from the perceptual analysis accomplished by a listener with two ears and a brain that processes the information.

The Schroeder decay plot can be calculated from the impulse response (using a backward integration) and shows the ensemble of the decay of sound in the room. Using the slope of the Schroeder decay plot between a range of decays, the reverberation time can be computed. If the impulse response is filtered with a bandpass filter, the Schroeder plot can be used to compute the reverberation time in the filter passband.

In its strict usage, the term “reverberation time” (RT) applies only to a space that has energy arriving from multiple directions simultaneously and has developed a fully diffuse sound field, in the manner of the Sabine equation. In spaces, that do not have a classical diffuse sound field and therefore do not show an exponential decay, the term “decay time” is more appropriate to describe the time that sound takes to decay away. However, in the context that many readers are not particular familiar with the term decay time, the term reverberation time is used in this document, although not strictly correct.

The reverberation time of a space is determined by observing the rate that the sound level decays between specified values over time. One method of determining reverberation time is to utilize the Schroeder method, where a decay curve is generated by performing a reverse integration on the room’s impulse response. The slope of this decay curve is used for the calculation to determine the time that the sound takes to decay from one level to another. Most acoustic analyzers determine the decay time from a level of -5 dB to -35 dB, and then extrapolate this 30 dB decay time (T30) to the time for 60 dB (T60) of decay.

An associated metric for the rate of sound decay is the Early Decay Time (EDT), which is the duration sound takes to decay from an initial steady state level (0 dB) to a level approximately 10 dB lower. This quantity also has a high degree of correlation with the subjective perception of reverberation. In rooms that are highly diffuse acoustically the EDT and the T30 will have similar values. In rooms such as cinemas with large amounts of acoustic absorption and directional loudspeakers, there is a rapid decay of sound from the initial steady-state level. This rapid decay results from the combination of the loudspeakers’ directivity and sound-absorption properties of the surfaces that the direct sound from the loudspeaker strikes. In these rooms the EDT will be significantly shorter than the T30.

However, the section of the Schroeder decay plot from 0 dB to -10 dB cannot provide an indication of the reverberation time that would be heard with an impulsive source, such as when clapping in the room. After a level of around -15 dB is reached, the decay of sound usually becomes approximately exponential and can therefore be computed via the standard Sabine equation (or derivatives thereof). If the noise floor is sufficiently low, the Schroeder plot can be used to compute the “classical” reverberation time over the range -20 dB to -45 dB,

It is noted that the standard ISO 3382 uses the decay of sound from -5 dB to -15, -20 and -30 dB to compute a range of reverberation times, but these are usually measured with an omnidirectional source that does not produce the rapid initial drop noted above. In the venues that were measured, the sound decay in the early part of these periods would be greatly influenced by the loudspeaker directivity and therefore they are not suitable to assess the classical reverberation times of the venues.

In this report, the goal is to compare the classical reverberation times of the venues without including the effects of loudspeaker directivity. For the calculations of RT, the impulse response of the center channel system was filtered over the frequency range 500 Hz to 4 kHz and used to compute the Schroeder decay curve. A decay range of -20 dB to -45 dB was then selected as the region to determine the slope of the decay and compute the RT. The RT measurements presented in this report are not intended to replicate measurements undertaken with standardized methodology, e.g. ISO 3382, but are simply intended to indicate the RTs with an omnidirectional source.

Figure 8 shows a Schroeder decay plot with the reverberation time assessed over a 25 dB decay range from -20 dB to -45 dB.

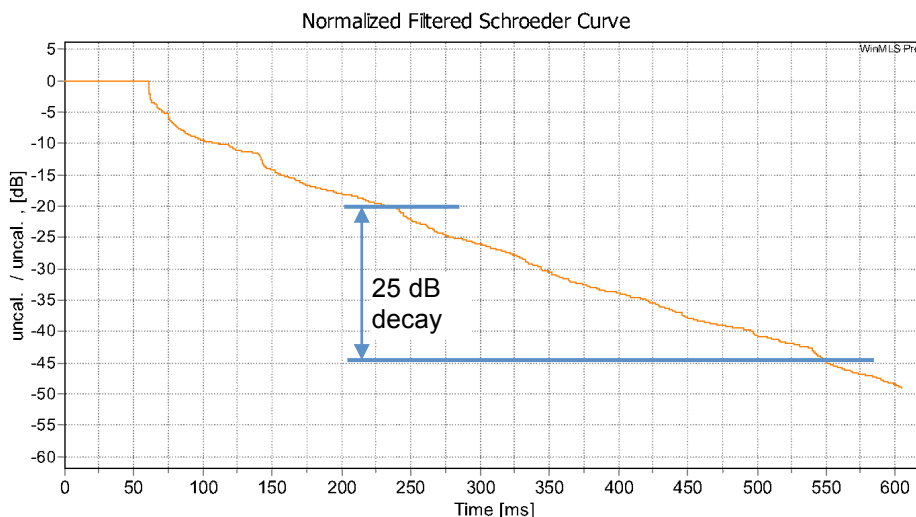

Figure 8 - Example of Schroeder decay plot for frequency range 500 Hz to 4 kHz.

9.2 Cumulative Energy

The cumulative energy plot shows the growth of sound energy in the room, beginning with the arrival of the direct field from the loudspeaker, with the level of discrete reflections and finally reverberation progressively adding to the sum. The cumulative energy is computed from the impulse response and is the progressive sum (or integral) of the squared time data expressed in dB.

Cumulative energy plots are presented for the center channel system in all venues in octave frequency bands spanning 63 Hz to 8 kHz which have been filtered using a one-octave wide 4th order band pass filter. For ease of comparison between frequencies, the final value of the filtered plot is normalized to 0 dB.

When using filters to compute temporal room acoustic parameters, it is essential to understand how the intrinsic temporal response of the filters can affect the results. To gain an insight into this, Figure 9 shows the cumulative energy of an ideal impulse after filtering with one-octave wide 4th order band pass filters.

The cumulative energy pattern is a function of many parameters:

- loudspeaker directivity and the acoustic absorption of surfaces receiving the direct field
- strong discrete reflections and echoes
- reverberation time

The cumulative energy plot generally reaches its asymptotic value more quickly as the frequency increases as loudspeaker directivity is generally greater at high frequencies and reverberation times are generally lower. Marked discontinuities such as jumps in the cumulative energy plot are due to the arrival of a strong discrete source, such as a delayed loudspeaker or an echo.

To facilitate comparison of cumulative energy plot between venues, the impulse responses were processed to remove the flight-time from the impulse response. In each processed impulse response, the first arrival occurs at 1 ms.

Although the perception of reflections depends on the frequency, and their arrival time and level relative to the direct field of the loudspeaker, it is beyond the scope of this report to discuss the audibility of reflections. The reader is referred to (1) for further information.

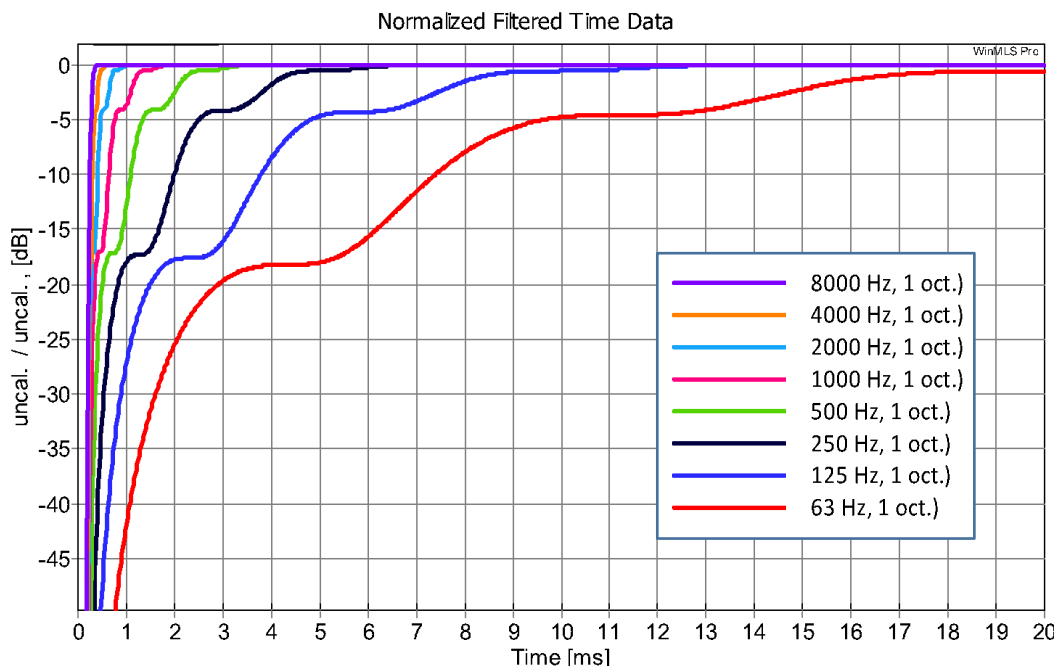

Figure 9 - Cumulative energy of ideal impulse after filtering with one-octave wide 4th order bandpass filters.

10 PROCESSING OF FREQUENCY RESPONSES

This section discusses four processes that have been applied to the measured responses:

- normalization
- spatial averaging
- computation of extremes of a particular family
- smoothing

10.1 Normalization

10.1.1 Overview

Two parameters important to the listening experience are the overall sound pressure level and the frequency response in the listening area.

Variations in the overall level over the listening area result from factors relating to i) the direct sound such as geometric spreading loss (aka distance or inverse square loss) and loudspeaker directivity and ii) room reverberation and to a lesser extent, room reflections. Variations in frequency response over the listening area can result from loudspeaker directivity that is not constant with frequency, as well as room factors such as reflections and diffraction.

In general, the dominant sound field in typical listening spaces can be divided into three types according to frequency range. At low frequencies, reverberation is dominant; at mid frequencies, the dominant sound is direct with early reflections, while at high frequencies, it is primarily direct sound. Defining the extent to which this applies in the venues is a goal of this investigation.

Determining the average spectral variation over a listening area by examining the range of frequency responses is a useful technique to assess the ability of a system to be properly equalized. However, to provide a proper basis for this equalization, two factors must be addressed:

- All responses must be normalized to a common reference level so that overall level differences between positions do not skew the spatially averaged response especially when using power averaging.
- Responses must be measured at a sufficient number of positions to attenuate the effects of non-minimum-phase phenomena. These phenomena often vary from seat to seat.

10.1.2 Normalization Process

Normalization of the frequency responses was undertaken for two reasons:

- Easier viewing of frequency graphs
- Removal of the distance-loss component of the response

Normalization was undertaken by computing the average value of each response over the range of 500 Hz and 2 kHz and normalizing it to a level of 0 dB. These frequency limits have been selected on the following basis:

- The short 10 ms window can cause a loss of frequency resolution at frequencies below 500 Hz.
- Diffraction effects and room and seat reflections can cause large response variations at frequencies below 500 Hz.
- The upper limit of 2 kHz corresponds to the break point in the X curve roll off.
- The range provides a neat two octave-wide bandwidth
- The directivity of the loudspeakers over this frequency range is generally less variable than over a wider range. If this range includes a crossover from a low to high frequency driver, the directivity can be variable in the crossover-transition range.

Air attenuation effects can be disregarded in the normalization process as the attenuation at 22 °C and 50% RH is 1 dB per 100 m at 2 kHz, (and 14.7 dB per 100 m at 10 kHz). This results in similar attenuations being applied to all microphones in a group; viz. audience and close-field.

10.1.3 Normalization of Screen and Surround Responses

To determine the Normalization Factor for the Left, Center, Right and Surround systems, the average level over the frequency range 500 Hz to 2 kHz at the reference position was first computed. The difference of this average level with 0 dB was computed to provide the Normalization Factor. The overall level of each microphone response was then adjusted by the Normalization Factor by (including the reference position). The end result of this process is that the average level of the reference position is 0 dB over the frequency range 500 Hz to 2 kHz, with the relativity of the responses at other positions being preserved.

The applicable normalization factors for each set of responses are noted on each graph.

10.1.4 Normalization of LFE Responses

For the LFE channel, the normalization was carried out over the range of 40 Hz to 100 Hz. With the close-field microphones, the normalization factor was computed for Microphone A.

The applicable normalization factors for each set of responses are noted on each graph.

10.2 Spatial Averaging

The spatial averages have been computed using arithmetic averaging of the individual responses, rather than power averaging. The following rationale is the basis of this use:

- When the power (or energy) average of a set of sound pressure spectra is found, the sound power of each spectrum is first computed, and then the average of all power spectra is computed, and converted back to sound pressure.
- As power is proportional to the square of sound pressure, locations with higher sound pressure have substantially greater sound power than locations with lower pressure. Locations higher powers can therefore dominate the average. For example, with sounds at 70 dB and 76 dB, the power average is 74 dB, whereas the arithmetic SPL average is only 73 dB.
- Research has shown that there is a relationship between subjective perception of sound and the frequency response of the reproduction chain. This is basis for the equalization of sound systems.
- The goal of the averaging process is to encapsulate the average listener perception, and not the power average of the space. In this context, arithmetic averaging has been used.

However, there can be problems with arithmetic averaging as well. Consider the situation of arithmetically averaging a phase cancellation of infinite dB with a peak of 3 dB, compared to the power average. In this case use of the arithmetic average would give a misleading response. However, in the acoustic domain, dips in the response of this magnitude are rare, due to the infilling of the nulls in the direct field response by reflections. This results in much less impact on the arithmetic average than would otherwise occur.

The use of arithmetic versus power averaging of sound pressure levels has merits from both perspectives. However, the reality with the responses in this report is that the difference in the average response at each frequency between the two methods is typically less than 0.5 dB. A difference of this degree will not change the conclusions of the report, as other factors are far more significant.

10.3 Range of Responses Maximum and Minimum extremes

The maximum and minimum extremes of a group of frequency responses are formed by taking the highest and lowest response at each frequency within the entire group. These extremes represent the upper and lower bounds of the range of responses within the group. An example of this is illustrated in Table 7.

Table 7 Illustration of method of forming the range of responses

Frequency	Response A dB	Response B dB	Response C dB	Maximum Extreme dB	Minimum Extreme dB
100 Hz	3	1	2	3	1
200 Hz	6	3	7	7	3
300 Hz	2	4	3	4	2
400 Hz	5	-1	2	5	-1

In the response graphs, the range of the responses is represented by shading between the maximum and minimum extremes

10.4 Smoothing

Smoothing of a frequency response is the process of applying a moving average to the raw frequency response, with the number of data points used for the average being associated with a particular bandwidth expressed as a fraction of an octave.



As the Fourier Transform operates on a linear frequency basis, smoothing that is applied as a fraction of an octave results in the number of frequency data points that are included in the average incrementing progressively per frequency data point. This also results in the number of frequency points per fractional octave increasing with frequency.

Selection of the optimum smoothing to use for a response involves consideration of a number of issues, which include the following items:

- When the loudspeaker responses measured in the venues are viewed with $1/12^{\text{th}}$ octave smoothing, they show the loudspeaker response and the effects on the response of multiple reflections from surfaces and objects that are both close and distant. Examples of close surfaces are seats and floor, while walls and ceiling are examples of distant surfaces. Reflections introduce substantial comb filters into the measured response, which can often conceal the intrinsic loudspeaker response. These comb filters introduce non-minimum phase components into the overall response. As they are neither temporally nor spatially consistent with the direct sound, they cannot be universally corrected by equalization.

Non-minimum-phase components in a response cannot be corrected by equalization.

- If the $1/12^{\text{th}}$ octave smoothed responses are averaged over numerous locations, the non-minimum phase response effects are substantially averaged, allowing the overall response of the loudspeaker to be more readily seen.
- The high degree of detail provided by $1/12^{\text{th}}$ octave smoothing hinders comparison of the responses between venues.
- When the responses are smoothed using a sliding $1/3^{\text{rd}}$ octave filter, the effects of the room reflections are diminished but are still evident, allowing loudspeaker response problems to be better seen, as long as the bandwidth of these problems is larger than the smoothing interval.
- Using a sliding one-octave filter, the effect of the room reflections on the responses is further diminished. However, the smoothing bandwidth is so wide that response issues concerning loudspeaker and equalization can be masked by the smoothing. One important benefit of octave smoothing is that the relative overall levels of wide frequency ranges can be compared between venues. Examples of such comparison are the overall levels of the high, mid and low frequency ranges.

11 RESPONSES PRESENTED

The responses of each venue are shown in Sections 15 to 20 and are organized as follows for each test case:

- Description of the test
- The response graphs with captions
- Discussion of the results

The discussions of results in this section focus on the data in the graphs. Had the microphones been positioned differently in the tested theatres, the variances between the measurements may have been different. The data is shown with $1/12^{\text{th}}$ octave smoothing. If smoothing with a wider bandwidth had been used, e.g. $1/3^{\text{rd}}$ octave smoothing, many of the steep peaks and dips would be attenuated.

11.1 Comparison of microphone position and time windows for left, center, right channels at listening positions

Results are presented for left, center, right channels using three different time windows (window lengths of 50 ms, 48 PPO, and 2 second windows are used) and have four components:

- Response at the reference listening position.
- The range of response values taken from all the responses at the different listening microphones (which lie between the maximum and minimum extremes).
- The arithmetic average response over the range of microphone positions in the audience area.
- The close field microphone responses of Venue B were averaged on a power basis.

As noted above, all responses have been smoothed over a bandwidth of 1/12th octave.

11.2 Comparison of microphone position for LFE channel at listening positions

The responses of the LFE channels are compared using a 2 second window for the following parameters:

- Response at the reference listening position
- The range of response values taken from all the responses at the different listening microphones (which lie between the maximum and minimum extremes).
- The arithmetic average response over the range of microphones positions.
- With and without the as-found equalization for the reference position and the average response.

All responses have been normalized to the average level of the reference position over the range 40 Hz to 100 Hz.

Note that the response without equalization was only measured in certain venues. In these venues, normalization was not used for the comparison of equalized and unequalized responses.

11.3 Comparison of microphone position for surround channels at listening positions

The number of surround channels that were measured was not consistent among venues due to time constraints. At a minimum, left channel surrounds were measured in all venues (Left Surround, Left Side Surround, Left Rear Surround). Other channels are presented if they were measured. To reduce the range of plots, only the responses with 48 PPO are shown.

11.4 Effect of Microphone Responses

The report presented in Annex D showing the comparison of measurement microphone responses does not identify the microphone brand and type, and therefore cannot be used to adjust the responses presented in this report to account for the microphone responses.

A comparison of the two microphones that were used is therefore based on manufacturers' data.

a) Audix[®] TM1 microphone

- As noted earlier, the Audix[®] TM1 microphone was used for all venues except Venue B.
- The microphone was located at a grazing incidence to the sound emitted from the loudspeakers, i.e. at 90° upwards.



- The data sheet for the TM1 shows a shallow depression of 2 dB between 6 kHz and 10 kHz, with the response at 20 kHz being 0 dB.
 - The polar data shows the response at 90° to be at – 2 dB up to 4 kHz, -3 dB at 8 kHz and -9 dB at 16 kHz.
 - Combining the axial and polar responses would indicate that at 90° incidence angle, the response at 10 kHz would be down 5 dB compared to the level at 1 kHz. Interpolating the polar graph, would indicate that the response at 6 kHz is down 2.5 dB at 90°.
- b) Beyer® MM 1 microphone
- As noted earlier, the Beyer® MM 1 microphone was used for Venue B.
 - The microphone was located at a grazing incidence to the sound emitted from the loudspeakers, i.e. at 90° upwards.
 - The data sheet for the MM 1 shows a rise of 3dB at 10 kHz, continuing up 5 dB at 15 kHz.
 - The polar data shows the response at 90° to be at 0 dB up to 4 kHz, -1 dB at 8 kHz and -5 dB at 16 kHz.
 - At this grazing incidence angle, the response at 10 kHz and 15 kHz would be very similar to the response at 1 kHz.
- c) Effect on Results

The effect of these different overall responses will be to decrease the amount of high frequency level in Venues A to E by up to 5 dB at 10 kHz.

11.5 Figure Numbering, Labeling and Missing Responses

For ease of comparing the responses of one venue with another, the figure numbering has been held constant for all venues across the various channels and responses. The venue identifier precedes the figure number.

The graphs showing the frequency response with or without equalization can be identified as “EQ as found” (e.g. Figure 16 and Figure A.1 or a “Hse Eq” (e.g. Figure 10 and Figure B.1), which is a contraction of “House Equalization”. These graphs show the same information that of the existing response as the measurement team found it. This dual labeling scheme has resulted from retention of key attributes in the filenames of the pink noise .wav files throughout the entire processing and documentation phases.

In some venues, limited amount of time on site precluded the measurement of a complete set of responses. To provide the above-mentioned consistency of figure numbering, placeholders have been provided in the sections that do not have these responses.

12 COMPARATIVE ANALYSIS OF VENUES

12.1 Consideration of Frequency Responses

Certain measurement graphs illustrate the envelope or range of the maximum 1/12th octave values as well as the envelope of the minimum 1/12 octave values. In both cases the envelopes encompass the measurements taken across all the measured positions and room(s). An example of the maximum

and minimum envelopes is shown in

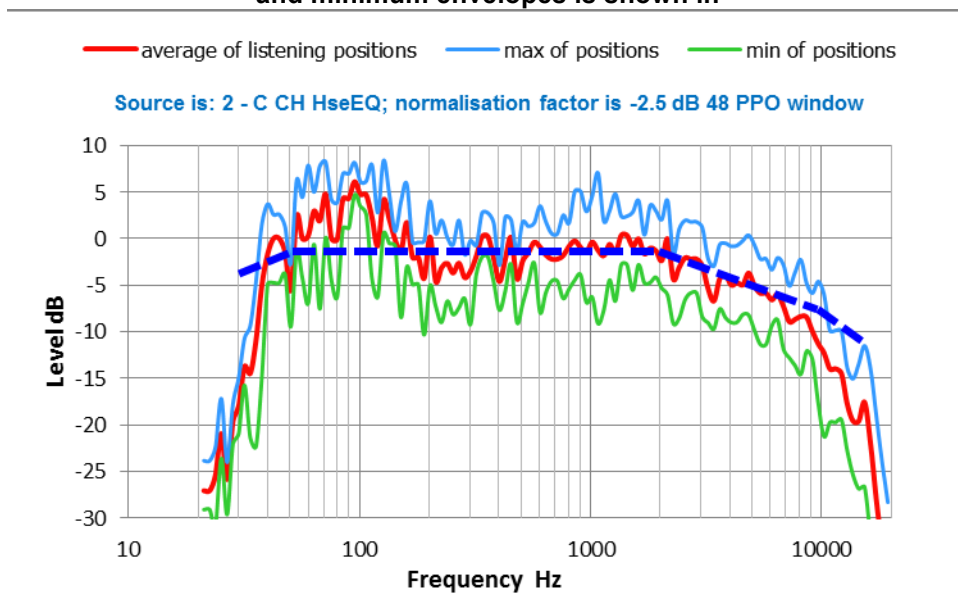

Figure 10 below.

The maximum or minimum envelope traces do not indicate that the rooms were tuned “incorrectly” or that the systems were “poor” or that they were examples of how the “X-curve” did or didn’t work. The envelopes simply show the range of the variance of the measured data plotted in 1/12th octave bandwidth data points (4 data points per 1/12th octave band at 48 PPO).

In order to draw conclusions regarding the envelopes, consideration must be given to the average trace (in red), which represents the trends found over differing locations.

It is noted that:

- Some graphs are presented with 1/3rd octave band smoothing while others are presented with 1/12th octave band smoothing.
- Many of the graphs are presented with a logarithmic frequency scale, as this was deemed to be the format that was easiest to interpret. However, it was not possible to easily implement the graphs showing the range (envelope) of responses with this frequency-axis format, and therefore the frequency axis uses equal increments at 1/3rd octave intervals.

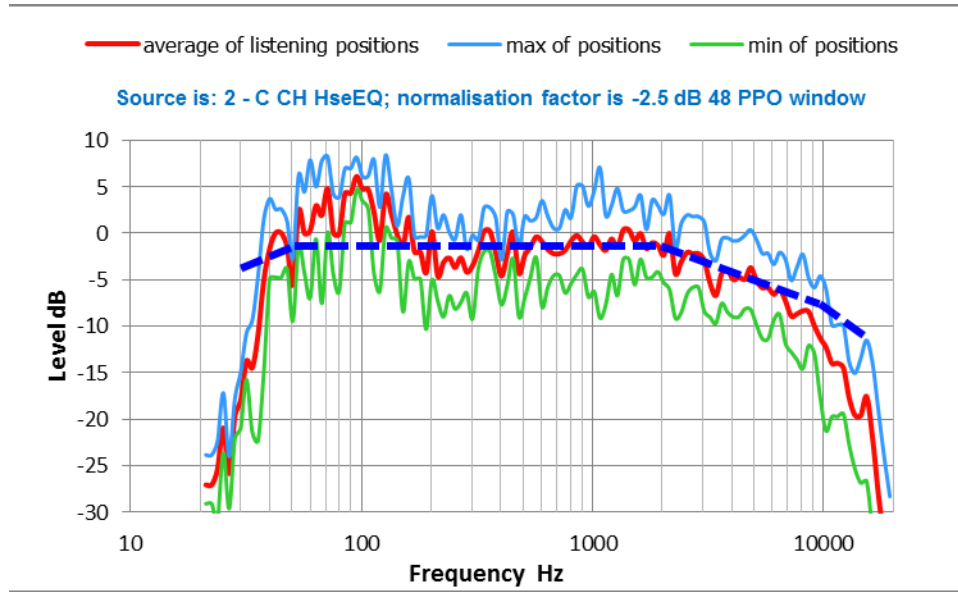

Figure 10 - Example of average response with maximum and minimum extremes and approximate X curve

Consequently, rather than present data with maximum and minimum curves, the data in this report will show the cumulative (maximum and minimum) variance of measured data as the envelope of the “range” of measured data, with the average or reference response as well. The graph above would then be presented as shown in Figure 11.

If the “X-curve” (that presumably the rooms were tuned to meet) is overlaid against the averaged data, the “X-curve” and the averaged response turn out to be reasonably well in alignment as “real-world” results, typically within a few dB with the exception of the LF. The measurement is agnostic as to relevance/non-relevance of the “X-curve”; it simply shows the trend as contrasted against the presumed X-curve tuning reference curve.

The caveat to keep in mind is that in these graphs, the 1/12th octave data points are being compared against a graphically smooth target “curve” which would represent a data smoothing of an octave band or greater; therefore differences are to be expected.

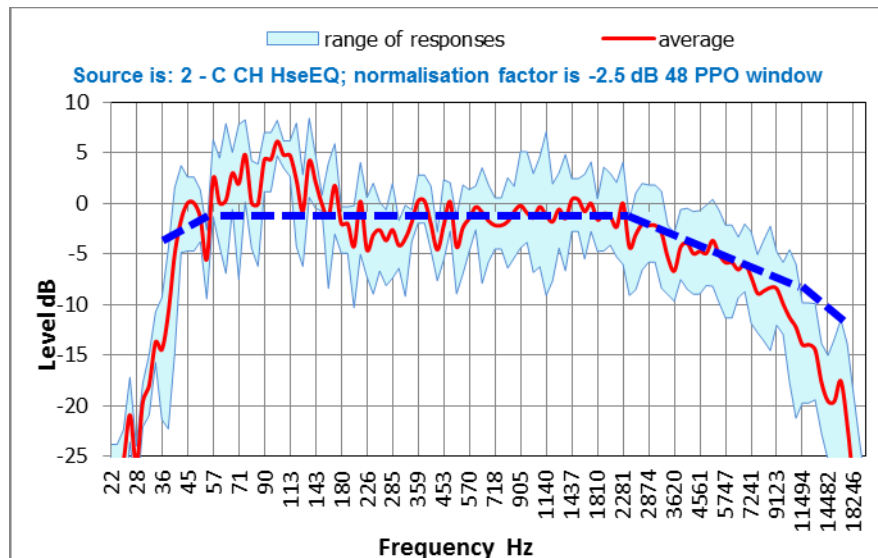

Figure 11 - Example of average response with range

Visual data reduction (smoothing) can be used in order to ensure that the measurement trends are readily apparent and are not obscured within the high-resolution minutiae and details. This is essential as the higher resolution data may imply an importance to the “wiggles” that is not really supportable in this situation.

Another consideration is that when examining high-resolution data (such as the 1/12th octave band data) the “wiggles” are the result of a number of key factors, which can often act in combination with each other, as shown in Table 8.

Table 8 Factors affecting the “wiggle” in the measured frequency responses

Factor Number	Description
1	Summation of direct sound plus reflections (includes both room boundary reflections as well as reflections with very short delay times, such as the reflections within horn mouths or from the screen).
2	The acoustic interaction of the physical components within the system (high pass/low pass transducers plus crossover response).
3	The acoustic response of the individual physical components (cone loudspeaker, compression driver/horn) restricted to their own passband.
4	Acoustic considerations of microphone placement relative to room boundaries (typically floor bounce impacting 250 to 400 Hz).
5	Acoustic considerations of room element phase response/cancellation (seat dip effect...a bit lower than floor bounce).
6	Acoustic considerations of lack of room absorbing power in the lower frequencies with longer wavelengths.
7	Acoustic considerations in smaller rooms of modal effects due to room volume/shaping such that Schroeder frequency is not, or is only partially, reached within the room.

These factors can be divided into categories for understanding what is inherent in the device versus what is a consequence of site conditions or measurement choices, as shown in Table 9:

Table 9 Association of the factor with the physical parameter.

Result of:	Factor Numbers
the physical location of the sound system	1
the manufacturer’s system design, the components used in the sound system, and their physical relationships	2 and 3
choice of measurement location	1, 4, and 7
the acoustic response of the room	5, 6, and 7

When all of these factors are taken into consideration, it can be a challenge to try to extract specific conclusions about the measured data in high-resolution format. This is why incorporation of smoothed data alongside the detailed “wiggles” is valuable, as it establishes the overall trends resulting from compilation of the discrete factors.

An illustration of the specific areas of the response that are impacted by these various factors is shown in Figure 12.

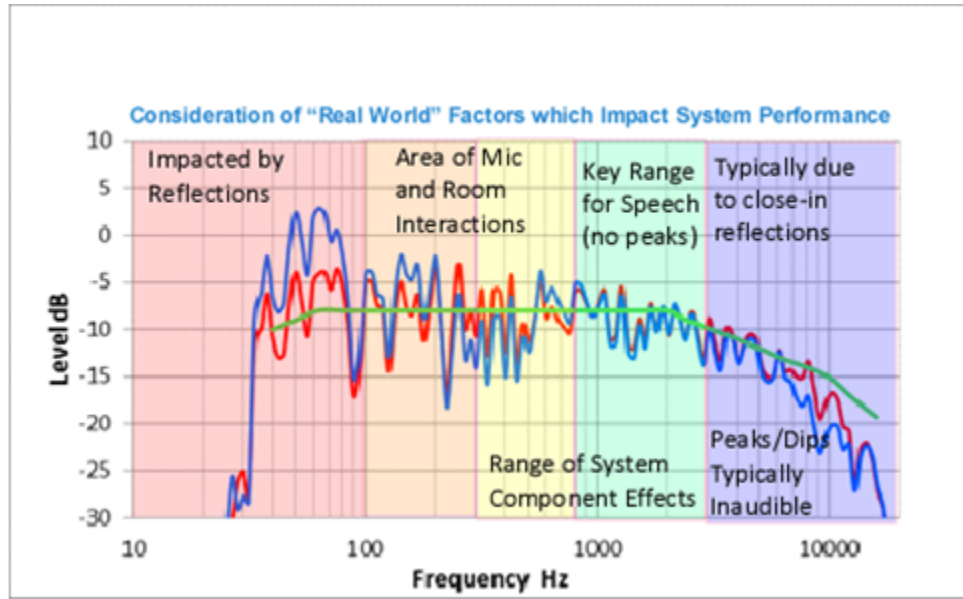

Figure 12 Illustration of frequency response measurement issues with key attributes.

Other observations to assist understanding the measured data are:

- a) When considering the 48 PPO responses, it is useful to note the FFT time window relative to the particular octave band, and the associated frequency resolution per each data "bin" in that octave band.
- b) As Figure 13 below shows, the lower octave bands are impacted by essentially the entire acoustic response of the room due to their relatively long time windows, while the short time windows of the upper octave bands includes reflections which are very close to the loudspeaker under test or to the measurement microphone.

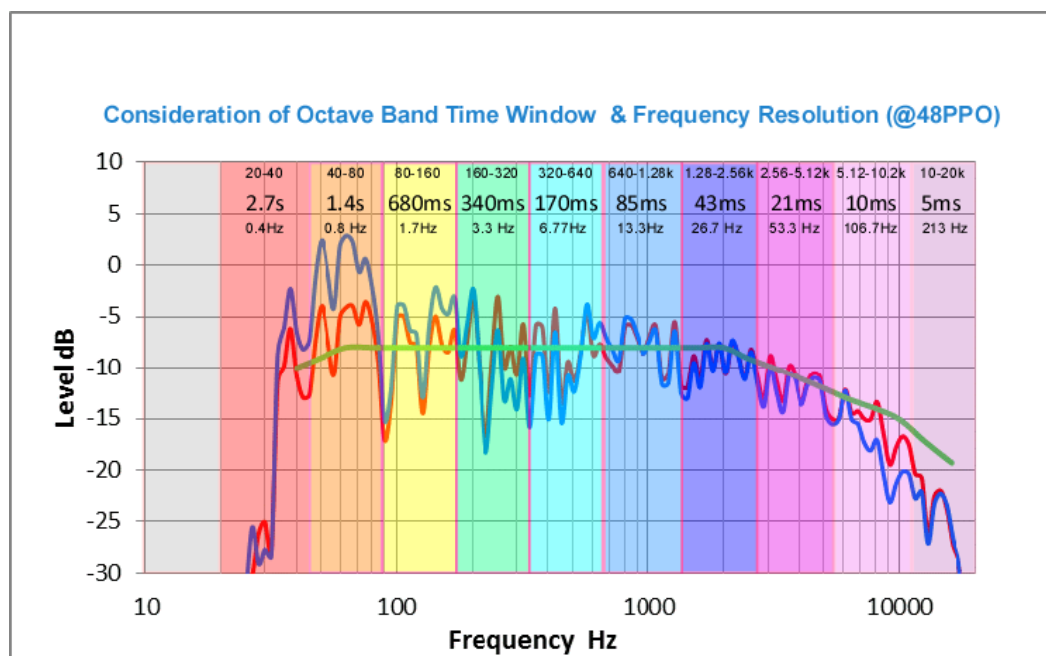

Figure 13 - Relationship between the time window and associated frequency range for the 48 PPO window.



A few more observations on understanding the measured data are:

- a) Finally, not all of the “wiggles” have the same audibility. This is due to a number of factors, including the bandwidth of the peak or dip in relation to the human aural temporal window as well as our relative insensitivity to dips in the frequency domain compared to peaks. Toole and Olive discuss this in References (19) and (20).
- b) Measurements with a 48 PPO window are generally the most useful; however different window lengths tell us different things and therefore, 48 PPO does not provide the complete picture. Many of the 50 ms responses show strong dips in the 100 Hz to 200 Hz region, which become somewhat filled-in in the 48 PPO responses, due to the later arrivals of reflected sound. The absence of this early energy shown in the 50 ms response would damage the intimacy and fidelity of the sound, due to a decrease in direct field for this early period of time.
- c) As noted in (1),(10),(13), the direct field of the loudspeaker is the most vital component for fidelity. But when examining the effect of early reflections on the sound, the duration of a particular direct field sound (e.g. a kick drum) must also be considered. If reflections arrive during that direct sound and cause a strong phase cancellation of that sound, the sound will lose impact and punch. Shorter time windows are useful for looking at this issue.
- d) It should be remembered that these microphones are collecting sound in a way than the ear responds; hence conclusions regarding the audibility of the differences between venues must be carefully made. However, the need for this mindfulness does not discount the value of the frequency responses presented in the report.

Whilst we know from the measurements that there will be some audible differences between venues, we cannot reliably predict exactly what they will be from the measurement responses alone. Traditional calibration philosophy would suggest that if the $1/3^{\text{rd}}$ octave spectra were equal in the audience area, then the perceived sound would be reasonably similar, but this cannot be reliably predicted for the same reason.

12.2 Summary of Venue Frequency Responses

12.2.1 Left, Center and Right Channels

Figure 14 shows the frequency responses of the left, center and right channels of each venue. The responses have been normalized and smoothed at 1/12th octave.

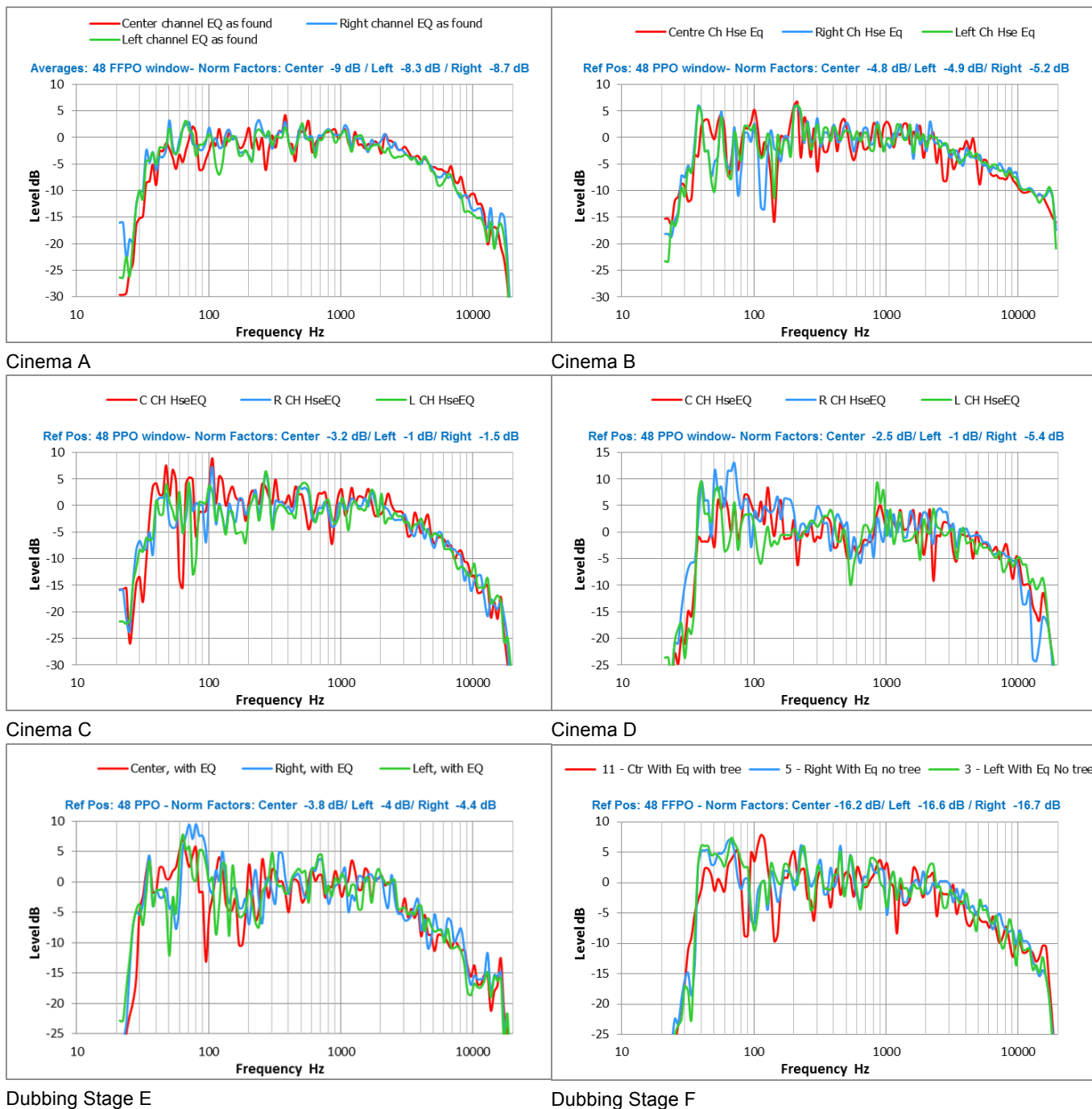

Figure 14 - Normalised frequency responses of center, left and right channels of all venues with 48 PPO time window.

12.2.2 Effect of Equalization on Center Channel and Comparison with X curve

Figure 15 compares the following responses for the center channel of each venue:

- the change in response due to equalization (where measured)
- the equalized response relative to the X curve

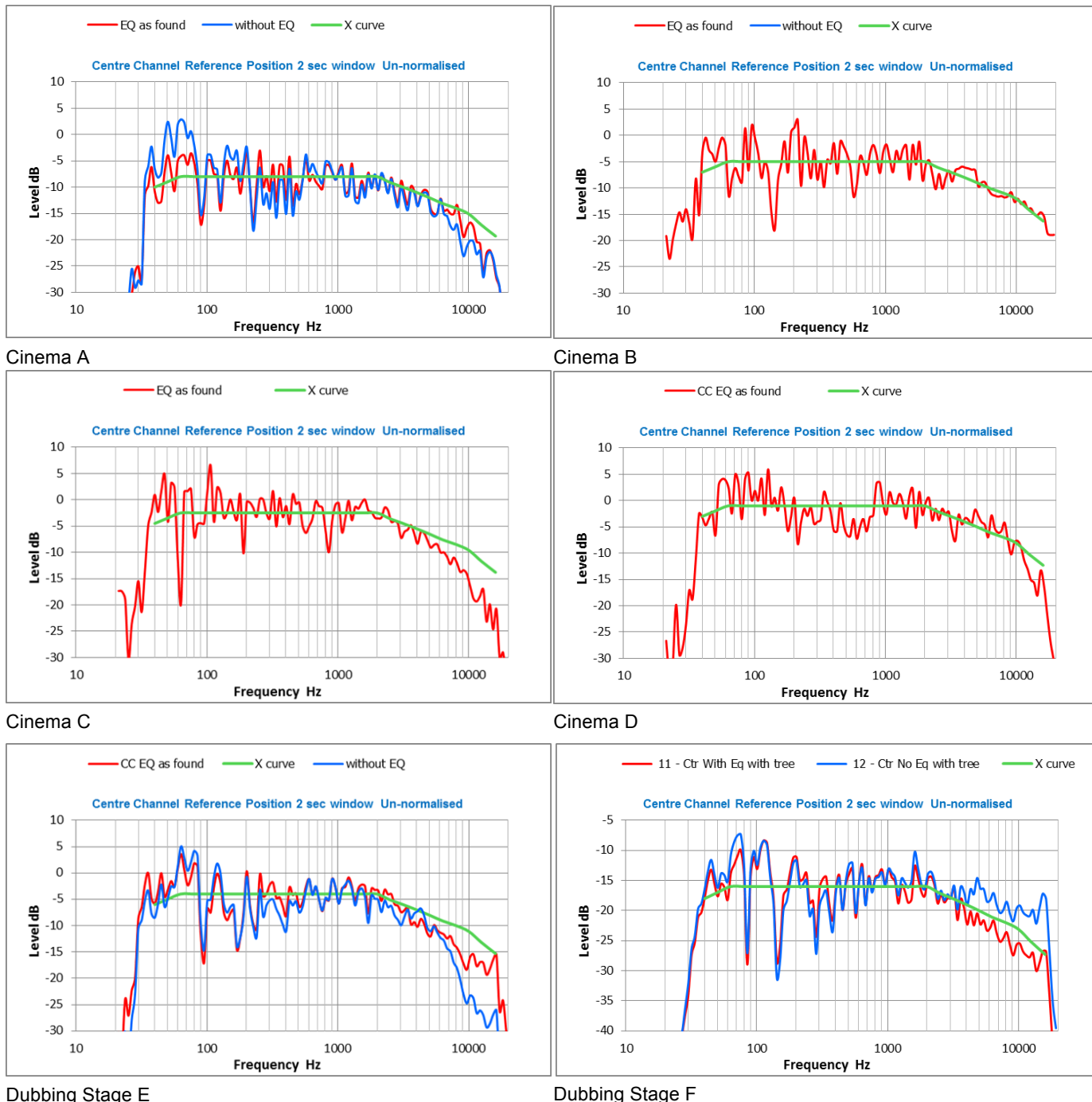

Figure 15 - Center Channel of each venue with and without eq (where applicable) with X curve overlaid

12.2.3 LFE channel

Figure 16 shows the responses of the LFE channel at each measurement position for all venues. Figure 17 compares the range of measured responses with the response at the reference position, while Figure 18 compares that range with the average response over those positions. All responses have been normalized and were computed using a 2 s window and smoothed at 1/12th octave.

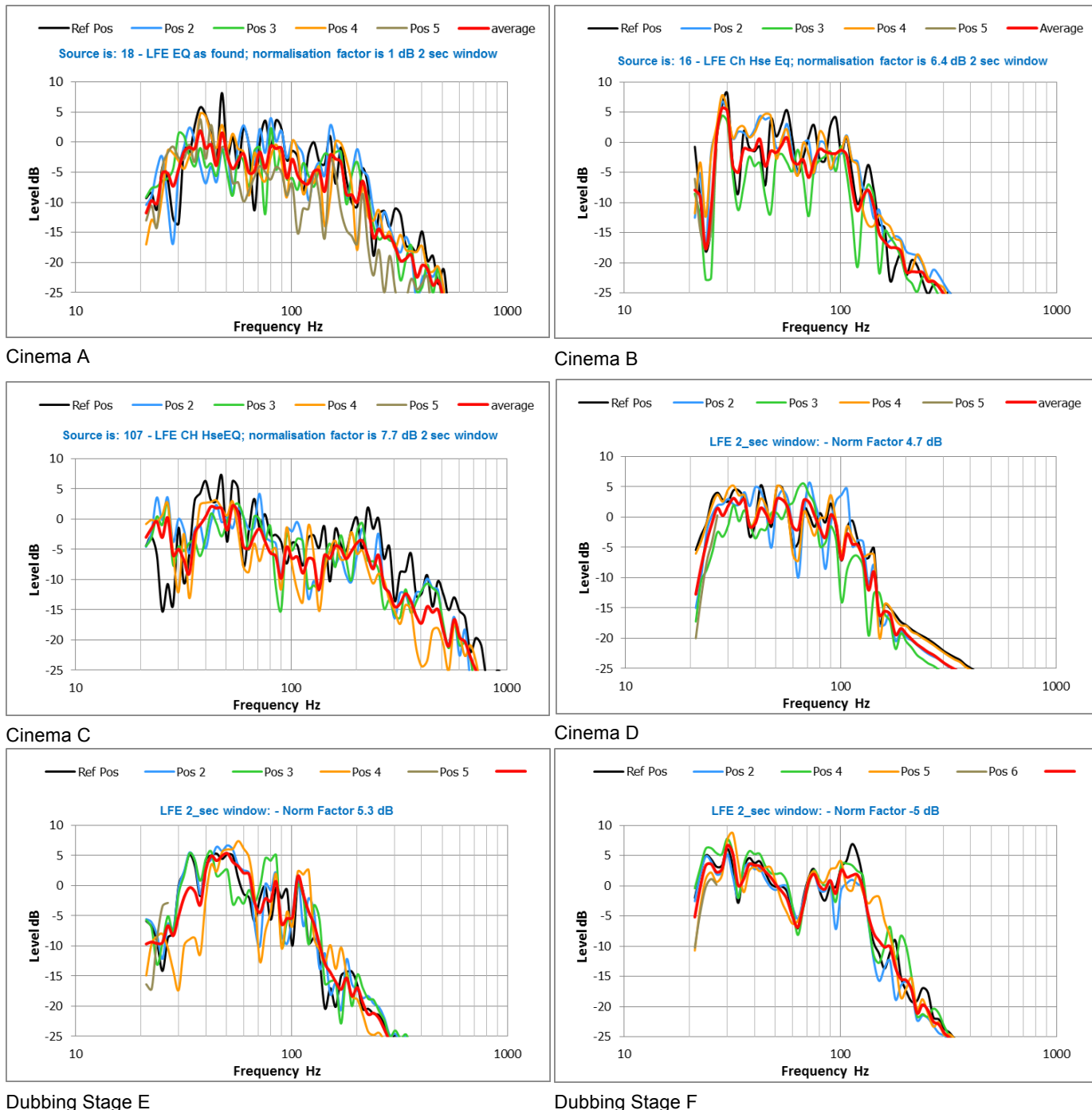
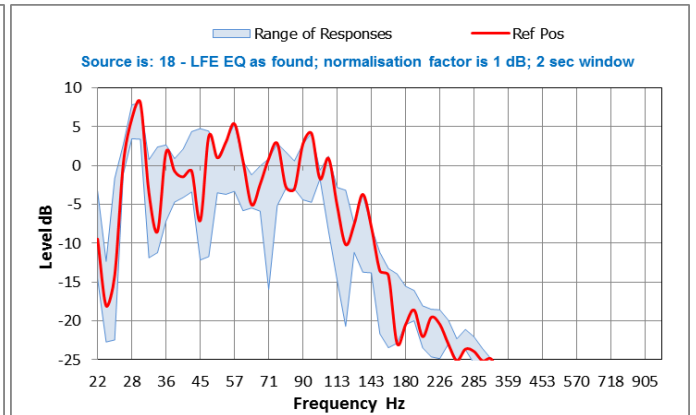
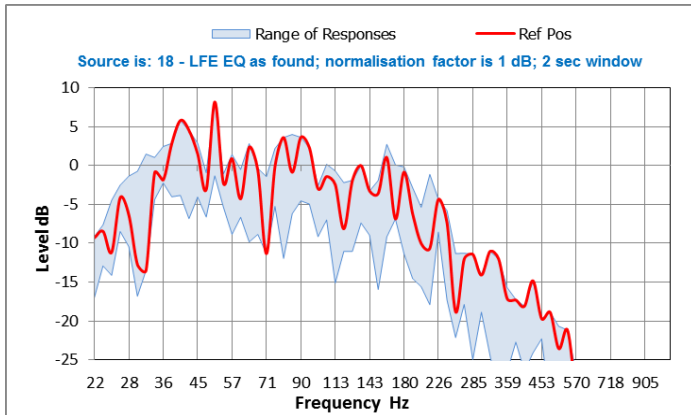
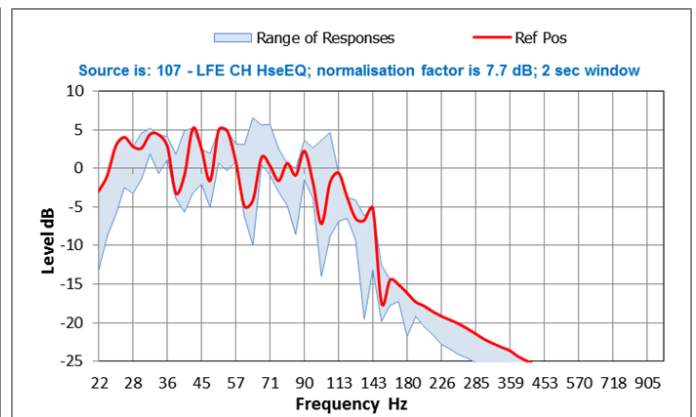
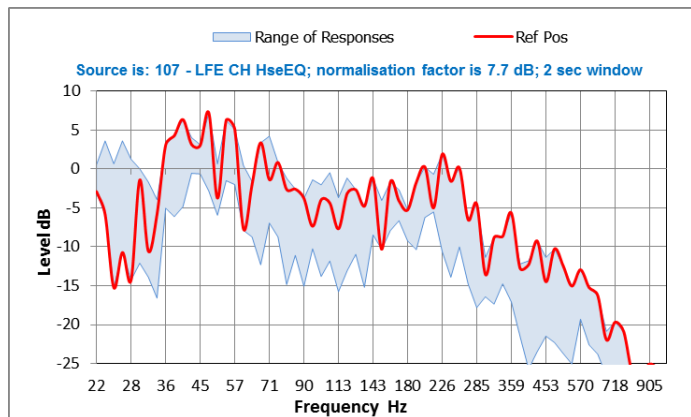

Figure 16 - LFE at each measurement position for each venue



Cinema A

Cinema B



Cinema C

Cinema D

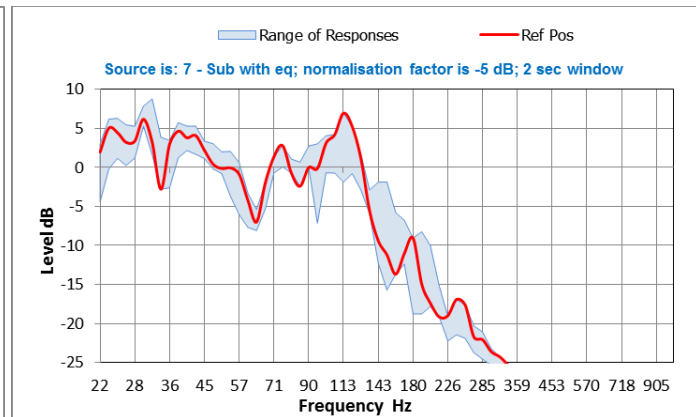
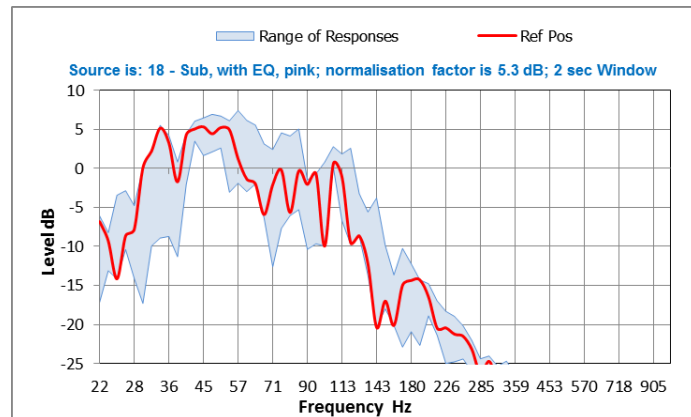

Dubbing Stage E

Dubbing Stage F

Figure 17 - LFE channel for each venue: Reference vs range of responses

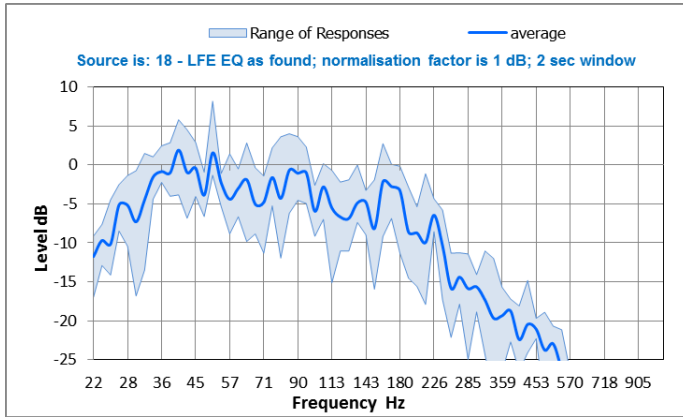

Cinema A

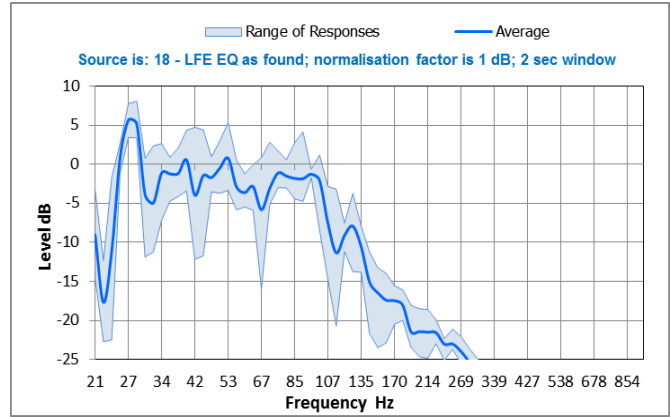

Cinema B

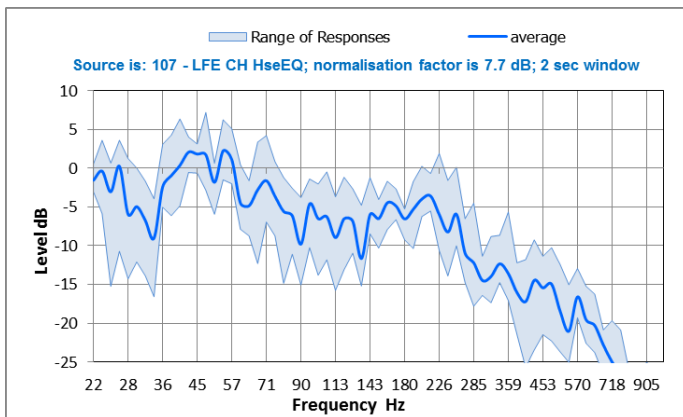

Cinema C

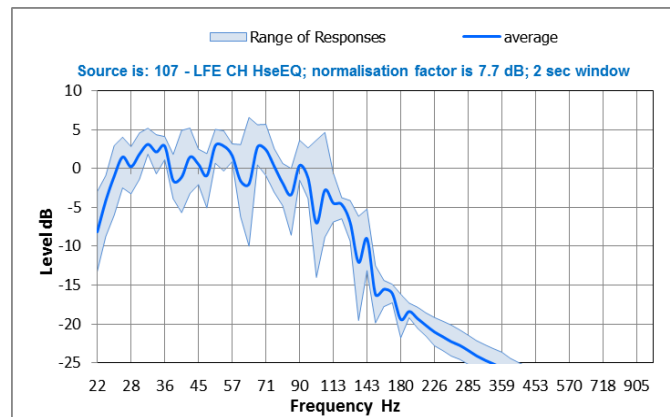

Cinema D

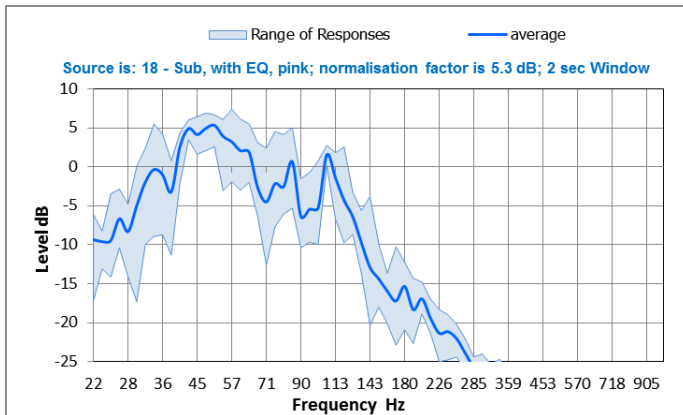

Dubbing Stage E

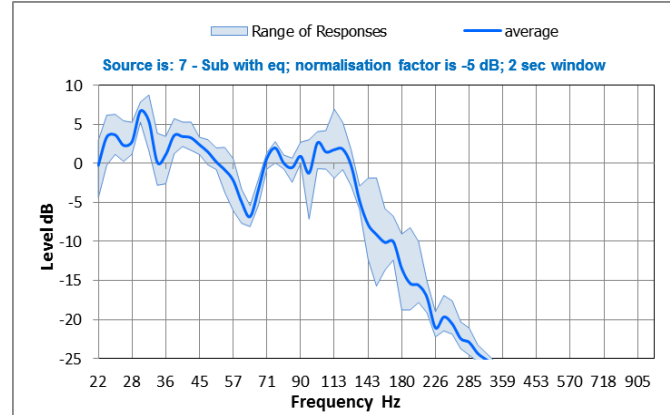

Dubbing Stage F

Figure 18 - LFE channel for each venue: Average response vs range of responses

12.2.4 Surround Channels

Figure 19 compares the responses of one surround channel at each measurement position with the average for that channel.

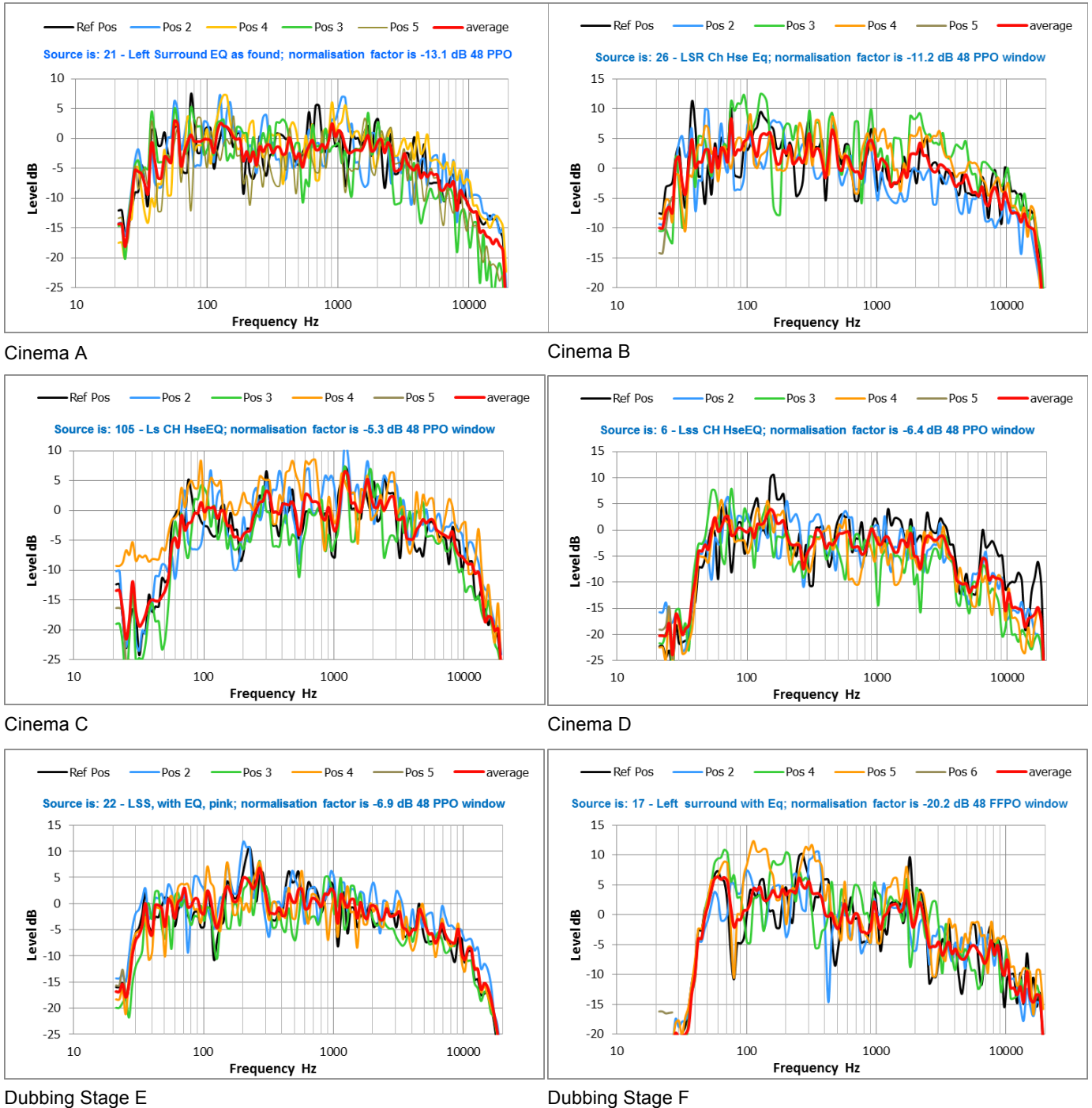

Figure 19 - One surround channel for each venue: Average response vs response at individual measurement positions

12.3 Summary of Venue Temporal Responses

12.3.1 Impulse Responses

Figure 20 shows the magnitude of the impulse response (in dB) of the center channel of each venue at the reference position filtered to range of 500 Hz to 4 kHz.

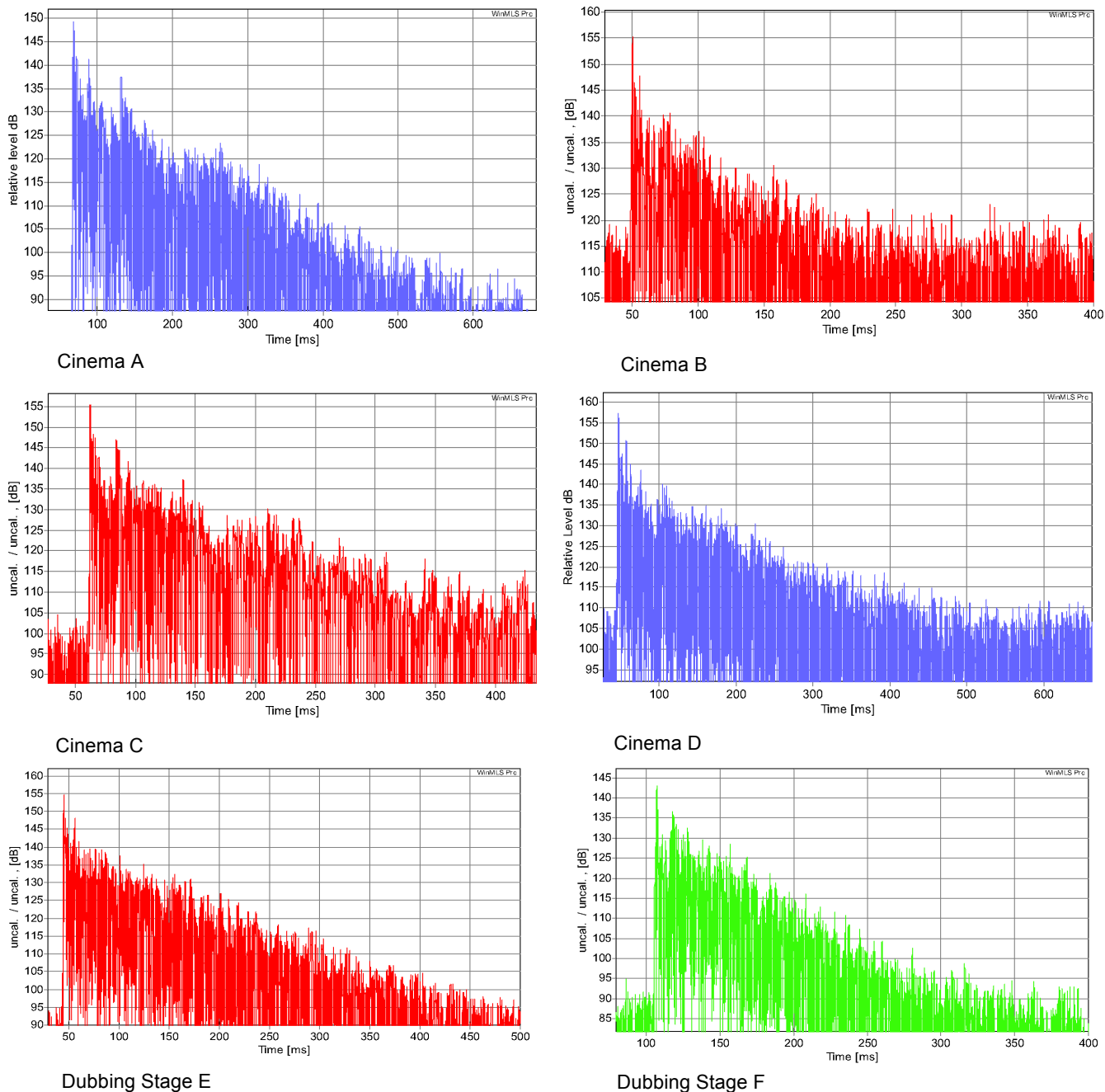
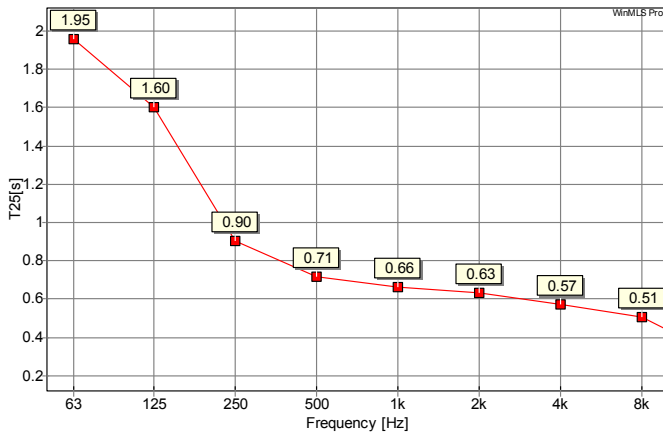

Figure 20 - Impulse responses (magnitude in dB) of each venue filtered to range of 500 Hz to 4 kHz for reference position with center channel.

12.3.2 Reverberation Times and Schroeder Decay Plots

Figure 21 shows the reverberation times in octave bands computed over the late period of the reverberation tail (to show the traditional reverberation times). Figure 22 shows the Schroeder decay plots of the center channel of each venue at the reference position filtered to range of 500 Hz to 4 kHz.



Cinema A

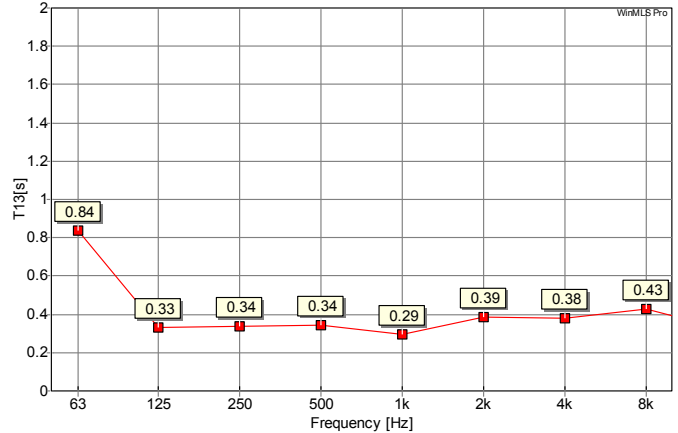

Cinema B

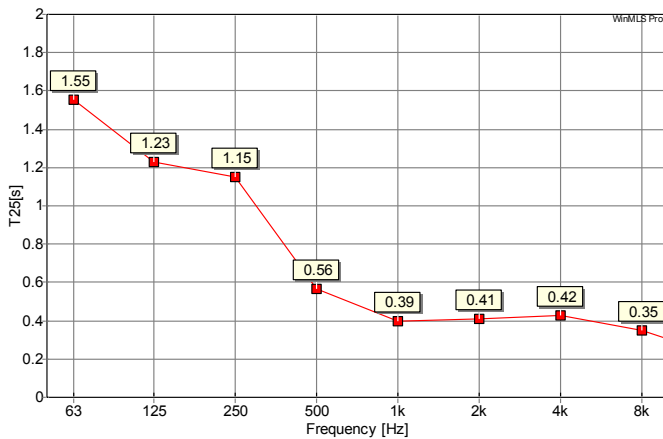

Cinema C

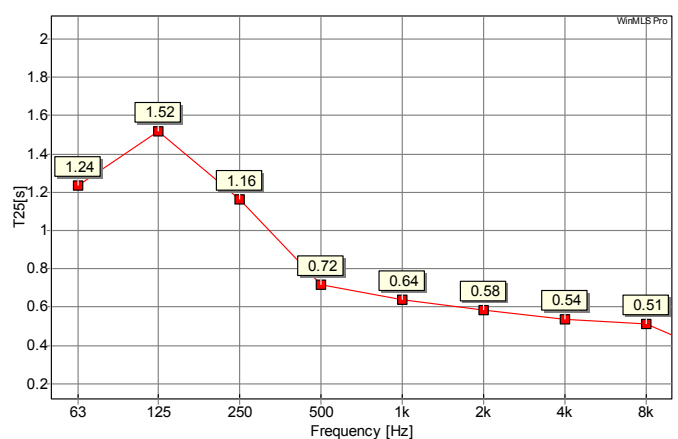

Cinema D

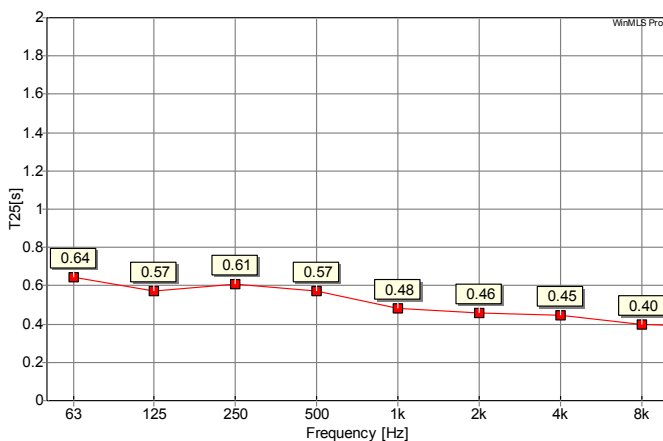

Dubbing Stage E

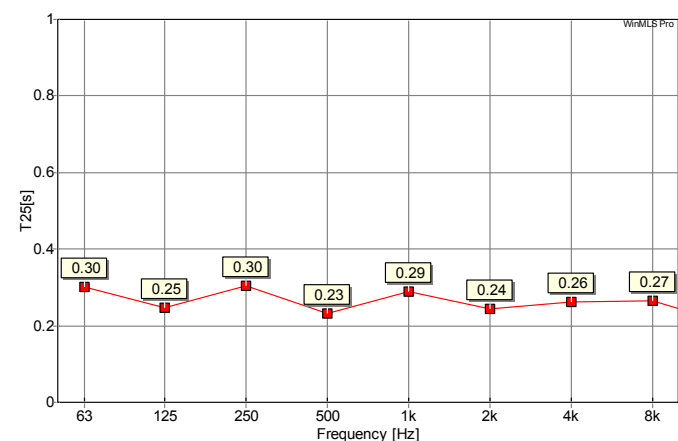

Dubbing Stage F

Figure 21 - Reverberation times of each venue for reference position with center channel.

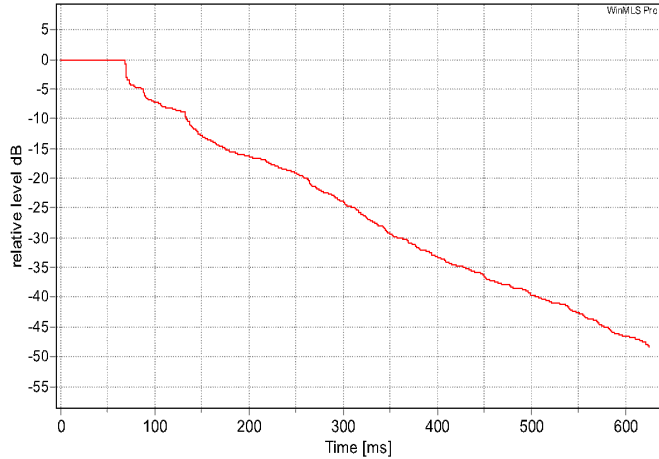

Cinema A

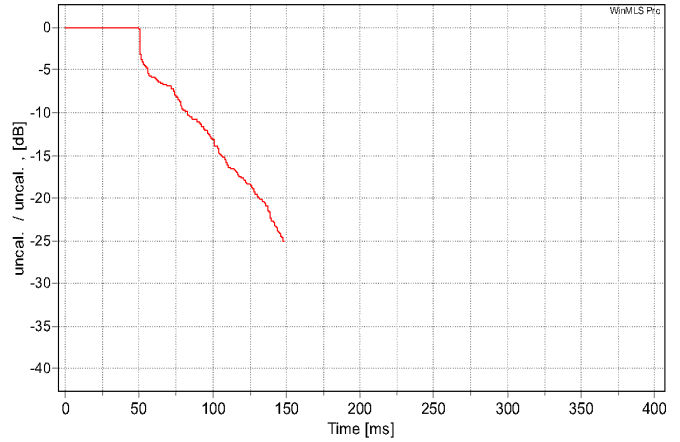

Cinema B

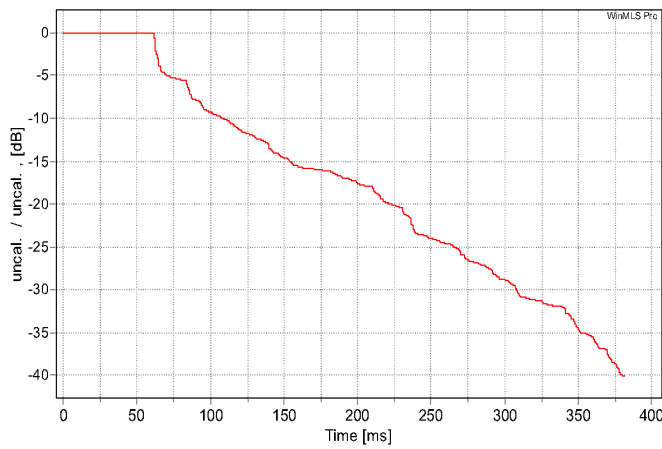

Cinema C

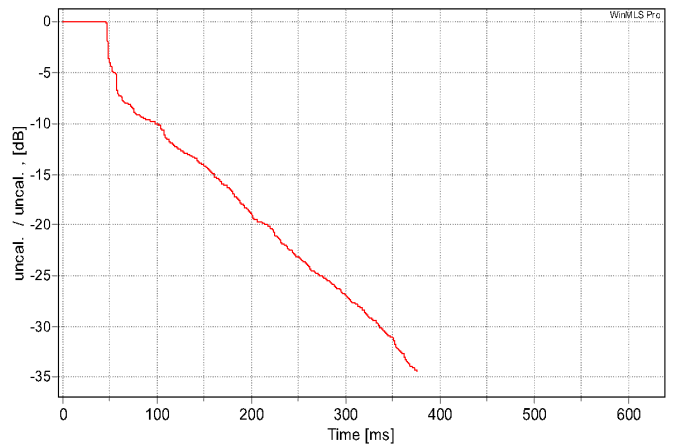

Cinema D

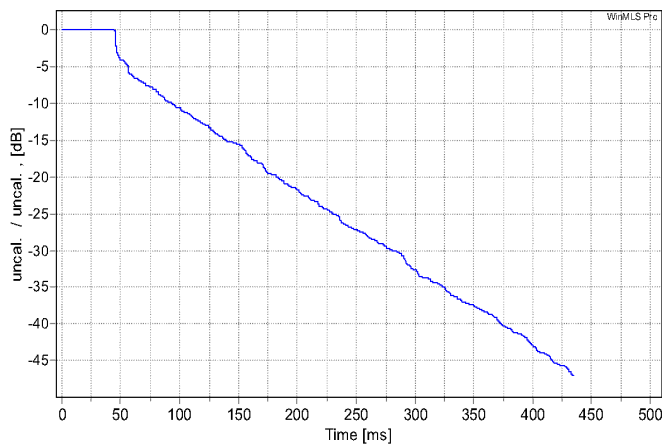

Dubbing Stage E

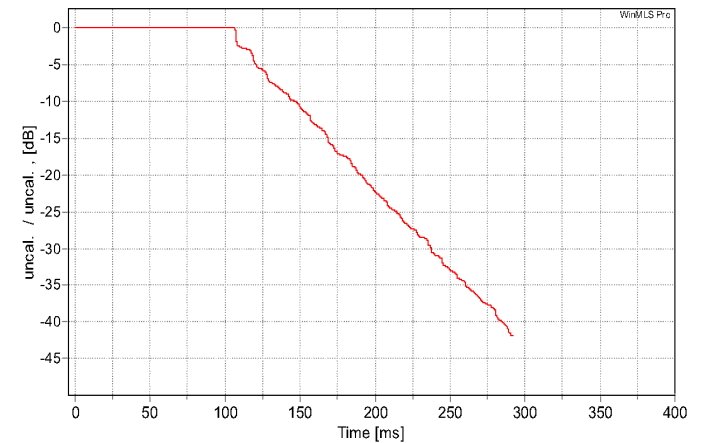

Dubbing Stage F

Figure 22 - Schroeder decay plots of each venue filtered to range of 500 Hz to 4 kHz for reference position with center channel.

12.3.3 Cumulative Energy

Figure 23 compares the cumulative energy plots of the center channel of the four cinemas at the reference position in the octave bands ranging from 63 Hz to 8 kHz. Figure 24 compares the cumulative energy for the two dubbing stages over the same frequency ranges.

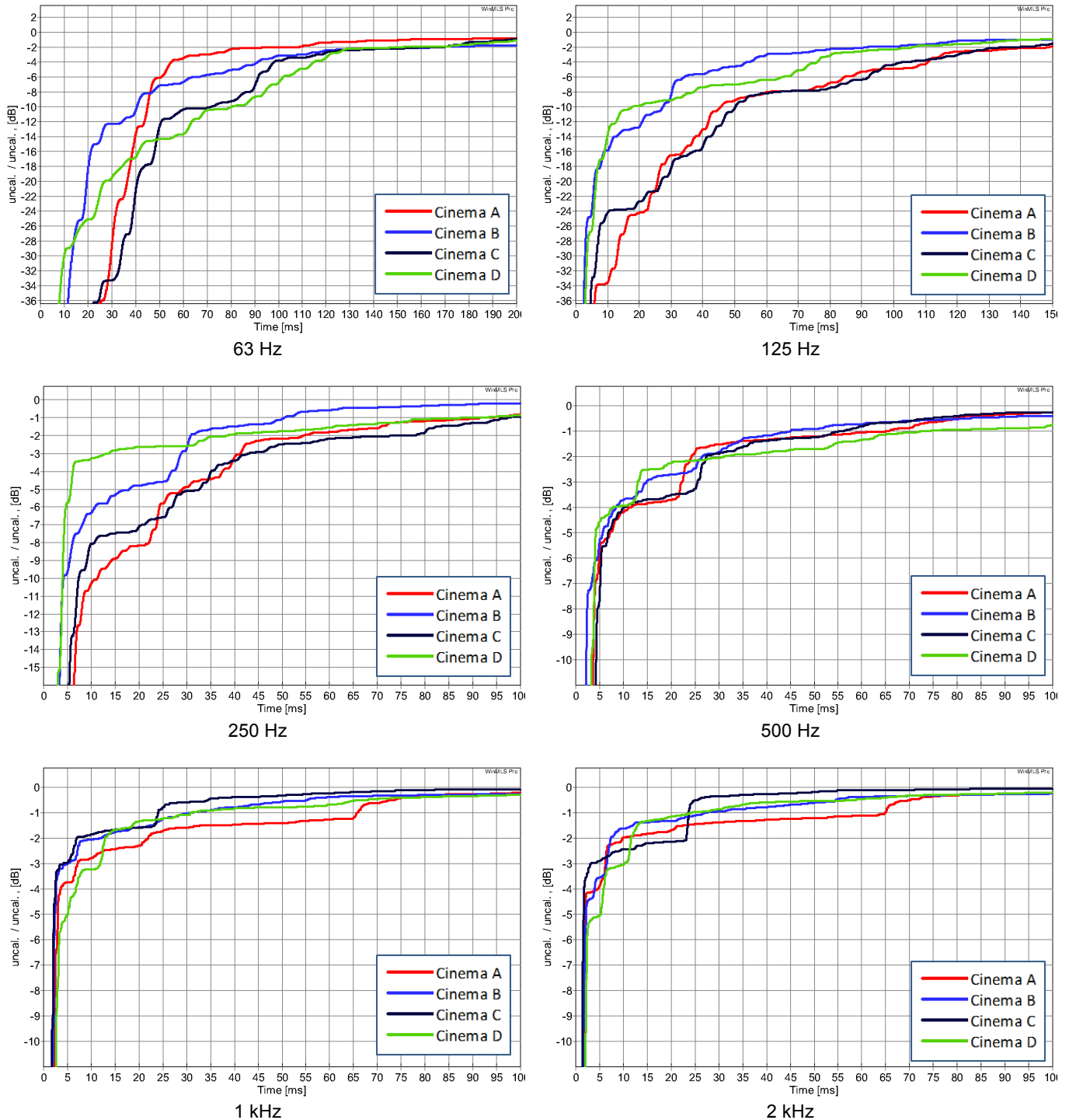

**Figure 23 - Cumulative energy plots in octave bands for all cinemas.
 Note the change of scales to suit the information.**

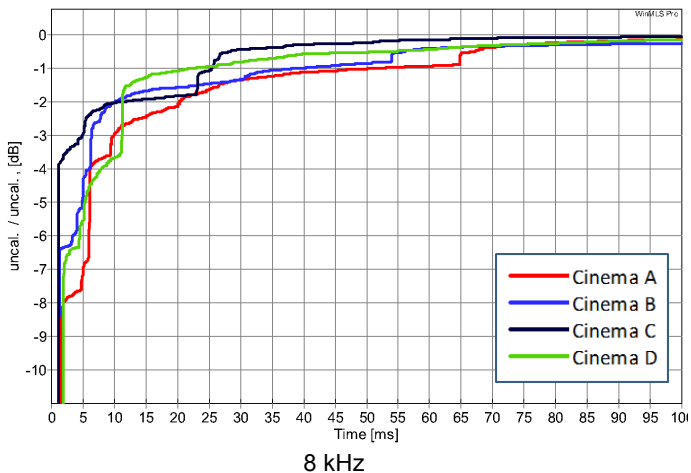
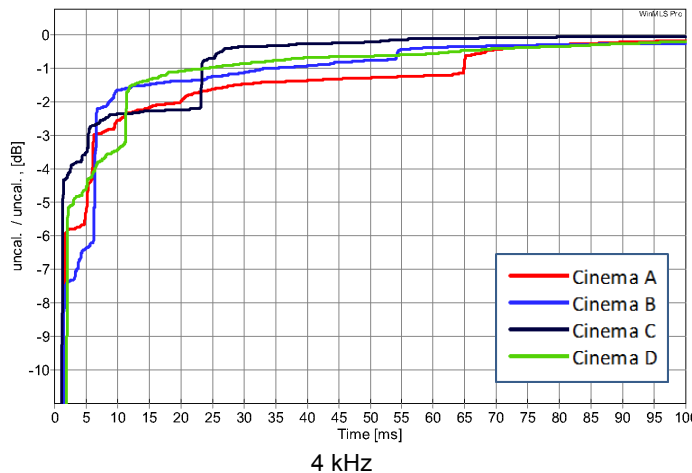
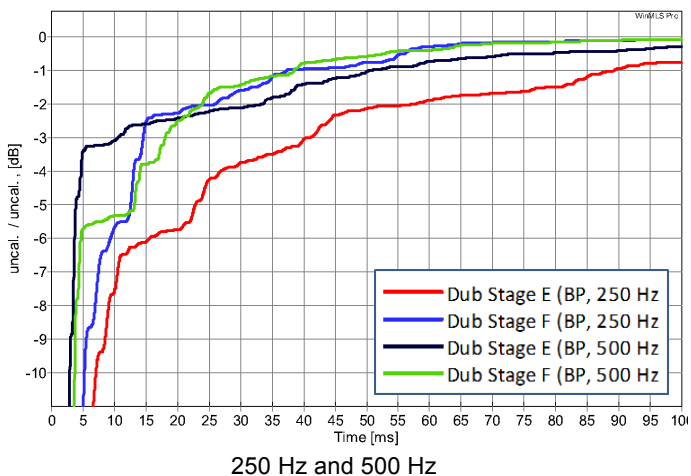
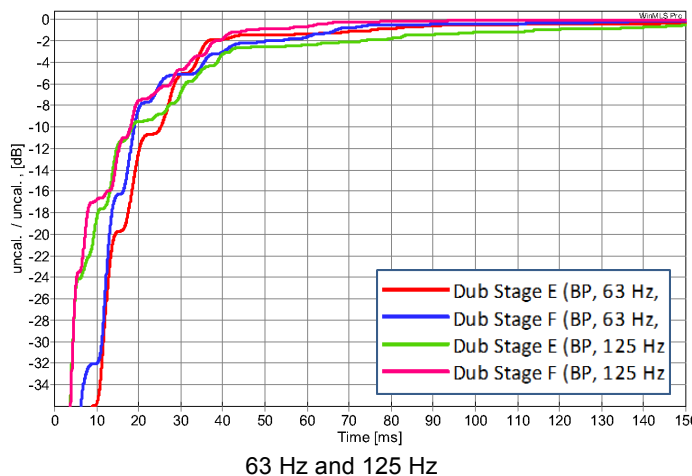
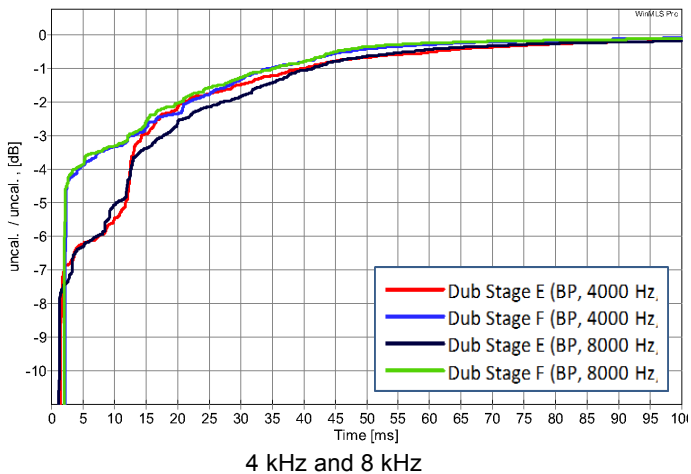
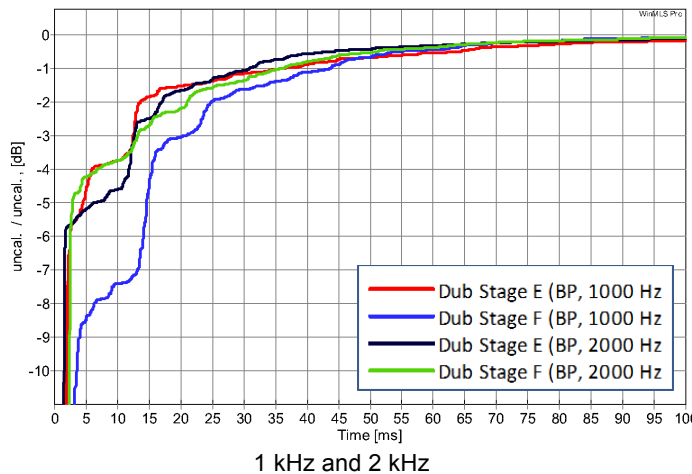

Figure 23 cont. Cumulative energy plots in octave bands for cinemas.
 Note the change of scales.



63 Hz and 125 Hz

250 Hz and 500 Hz



1 kHz and 2 kHz

4 kHz and 8 kHz

Figure 24 - Cumulative energy plots in octave bands for dubbing stages.
 Note the change of scales to suit the information.

12.4 Comparison of Frequency Responses of Cinemas and Dubbing Stages

Table 10 shows a list of the figures comparing responses for the two venue types. Each of these figures compares the following items for the four cinemas or two dubbing stages:

- Responses at the reference position
- Overall averages of the far-field microphones in each cinema
- Average of the reference position (Ref Pos) responses and the range of the individual Ref Pos responses
- Overall average of the average responses and the range over all the individual far-field responses

All responses are computed using the 48 PPO window.

Table 10 List of figures comparing responses for venue types.

Figure	Venue Type	Channel
Figure 25	Cinema	Center
Figure 26	Dubbing Stage	
Figure 27	Cinema	Left
Figure 28	Dubbing Stage	
Figure 29	Cinema	Right
Figure 30	Dubbing Stage	
Figure 31	Cinema	LFE
Figure 32	Dubbing Stage	
Figure 33	Cinema	Left Surround All Surrounds
Figure 34	Dubbing Stage	

12.4.1 Discussion

a. Center Channel

Cinemas (Figure 25)

- The average responses of Venues A, B and C are very similar and relatively flat from 40 Hz to 2 kHz, however Venue D shows a low frequency boost of 5 dB and a mid-range trough of 3 dB.
- The average of all the reference position microphones isn't quite as flat as the overall average, with the dip at 570 Hz resulting from Venue D. The low frequency energy below 120 Hz is raised by 2 dB compared to the mid frequency levels, which is primarily due to Venue D.
- The average over all venues and microphone positions is remarkably flat from 40 Hz to 2 kHz. There is a 1.5 dB hump in the 60 Hz to 150 Hz region.

Dubbing Stages (Figure 26)

- The reference position and average responses of the two venues both show a 5 dB boost below 100 Hz.
- The average of both the reference position microphones shows a slightly flatter response than the average over both venues and all microphone positions.
- The average responses of Cinemas A, B and C are flatter than the average responses of the dubbing stages. As there is greater number of microphone responses in the cinema group, it would be expected that the overall average response of cinemas would be flatter than that of the dubbing stages. Although

this bias will in no doubt be present, the fact that the average response of each cinema is flatter than those of the dubbing stages has significantly influenced the result.

b. Left Channel

Cinemas (Figure 27)

- The average responses of Venues A, B and C are similar and moderately flat from 40 Hz to 2 kHz, however Venue D shows a low frequency boost of 5 dB and a mid-range troughs of up to 4 dB.
- The left channels responses of Venues A, B and C are not quite as flat as those of the Center Channel.
- All venues have some form of response depression in the 100 Hz to 300 Hz region, which is likely to be related to the delays shown at these frequencies in the cumulative energy plots and caused by a phase cancellation from major reflection.
- The average of all the reference position microphones isn't quite as flat as the overall average, with the dip at 570 Hz resulting from Venue D. The low frequency energy below 120 Hz is raised by 2 dB compared to the mid frequency levels, which is primarily due to Venue D.
- The average over all venues and microphone positions is remarkably flat from 40 Hz to 2 kHz. There is a 1.5 dB hump in the 60 Hz to 150 Hz region.
- The overall averages of the Left and Center Channels are remarkably similar.

Dubbing Stages (Figure 28)

- The Left Channel responses are not as smooth as their Center Channel counterparts.
- The reference position and average responses of the two venues both show a 5 dB boost below 100 Hz.
- Both venues have some form of response depression in the 100 Hz to 300 Hz region, which is likely to be related to the delays shown at these frequencies in the cumulative energy plots and caused by a phase cancellation from major reflection.
- The average of both reference position microphones shows a slightly flatter response than the average over both venues and all microphone positions.
- The average responses of Cinemas A, B and C are flatter than the average responses of the dubbing stages.

c. Right Channel

Cinemas (Figure 29)

- The average responses of Venues A, B and C are similar and remarkably flat from 40 Hz to 2 kHz.
- The average response of Venue D shows a low frequency boost of 9 dB and a mid-range peak of up to 5 dB.
- Other than Venue D, the right channel reference responses of Venues A, B and C are slightly flatter than those of the Center Channel.
- All venues have some form of anomaly in the reference response in the 100 Hz to 300 Hz region, which is likely to be related to the delays shown at these frequencies in the cumulative energy plots and caused by a phase cancellation from major reflection.
- The average of all the reference position microphones is almost as flat as the overall average, with the dip at 570 Hz resulting from Venue D. The low frequency energy below 120 Hz is raised by 2 dB compared to the mid frequency levels, which is primarily due to Venue D.



- The average over all venues and microphone positions is remarkably flat from 40 Hz to 2 kHz. There is a 1.5 dB hump in the 40 Hz to 150 Hz region, resulting from Venue D's responses.
- The overall averages of the Right and Center Channels are remarkably similar.

Dubbing Stages (Figure 30)

- The Right Channel responses are slightly flatter than their Left Channel counterparts, but not quite as flat as the Center Channel.
- The reference position and average responses of the two venues both show a 5 dB boost between 50 Hz and 100 Hz.
- Both venues have some form of response depression in the 100 Hz to 300 Hz region, which is likely to be related to the delays shown at these frequencies in the cumulative energy plots and caused by a phase cancellation from major reflection.
- The average of both reference position microphones shows a slightly flatter response than the average over both venues and all microphone positions.
- The average responses of Cinemas A, B and C are flatter than the average responses of the dubbing stages.

d. *LFE Channel*

Cinemas (Figure 31)

- Between 30 Hz and 120 Hz, the responses at the reference positions lie within a window of 10 dB.
- The average responses of each venue show significant differences between venues. None of the responses is particularly flat.
- The consistency of LFE responses is much less than noted above for the screen channels.

Dubbing Stages (Figure 32)

- Between 30 Hz and 120 Hz, the responses at the reference positions lie within a window of 7 dB.
- The average responses of each venue show significant differences between venues. None of the responses is particularly flat.

e. *Surround Channels*

Cinemas (Figure 33)

- The average responses of the Left Surround Channel in Venues A and B are similar and reasonably flat from 70 Hz to 2 kHz. In contrast, those of Venues C and D show response anomalies of up to 5 dB.
- The relative flatness of the overall average response of ALL Surround Channels is primarily due to the combination of the number of the responses making up that average.
- Noting that the averaging process removes a large part of the non-minimum phase differences between microphone responses, the non-flat averages of Venues C and D can be considered to reflect overall behavior of these venues. On this basis, the responses of these venues can be classified as poor.



Dubbing Stages (Figure 34)

- Although the average responses of both venues show anomalies of up to 10 dB, the average response of Venue F is substantially worse than that of Venue E.
- Noting that the averaging process removes a large part of the non-minimum phase differences between microphone responses, the non-flat averages of Venues C and D can be considered to reflect overall behavior of these venues. On this basis, the responses of these venues can be classified as poor.

12.5 Applied Equalization

Figure 35 shows the frequency responses of the equalizations that were applied to Center channel system of three venues. These responses were computed as the ratio of the measured acoustic response with and without equalization at the reference position using a 2 sec window. The following points are noted:

- a) These responses have been measured in the acoustical domain and are not the actual results of the electrical measurement of the equalizer.
- b) As smoothing was applied to the frequency responses before the ratio of 'no-eq' to 'with-eq' responses was computed, the computed equalization response will not be identical to the electrical response, measured without smoothing.
- c) The equalizer responses show tiny ripples, which are due to small changes in the frequency response, arising from changes in the room reflection pattern between the 'no-eq' and 'with-eq' measurements.

These small differences in response become magnified when one response is referenced to another. Even a change in location of a single person in the room can produce sufficient changes to be noticeable.

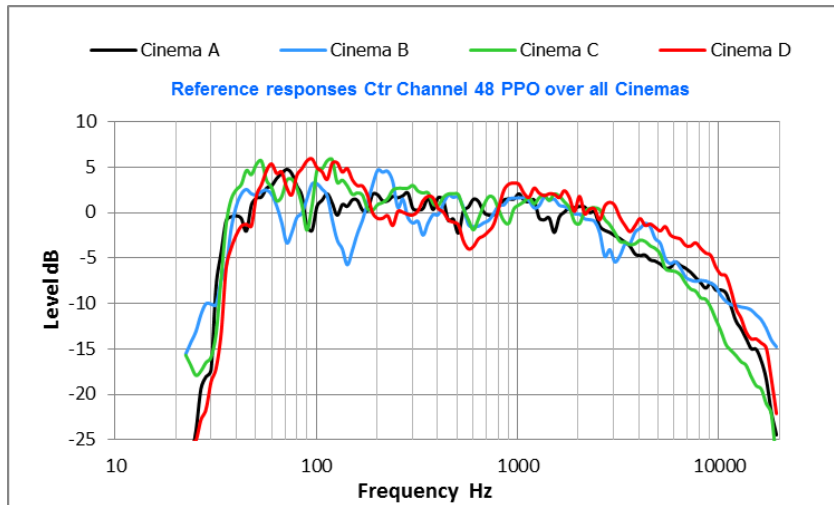

Responses of Center Channel at reference position of all cinemas smoothed over 1/3rd octave bandwidth with 48 PPO window. Response of each venue was normalized.

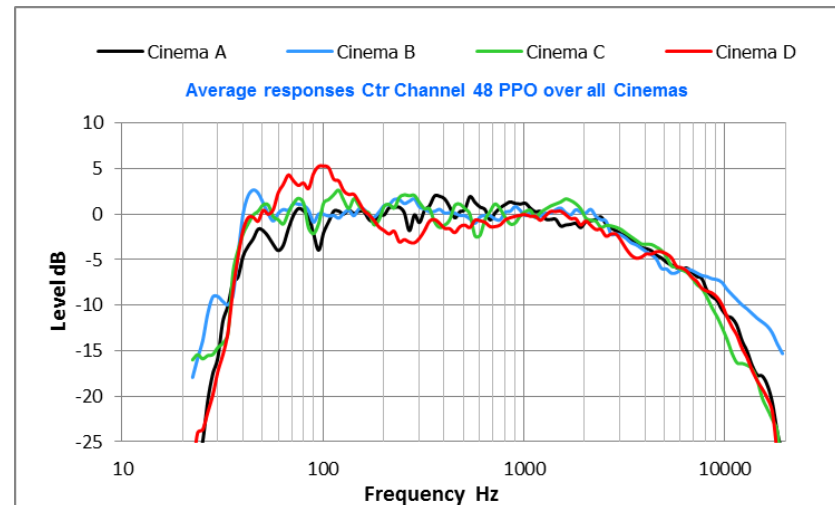

Average of responses over five positions of Center Channel of all cinemas smoothed over 1/3rd octave bandwidth with 48 PPO window. Responses were normalized before averaging.

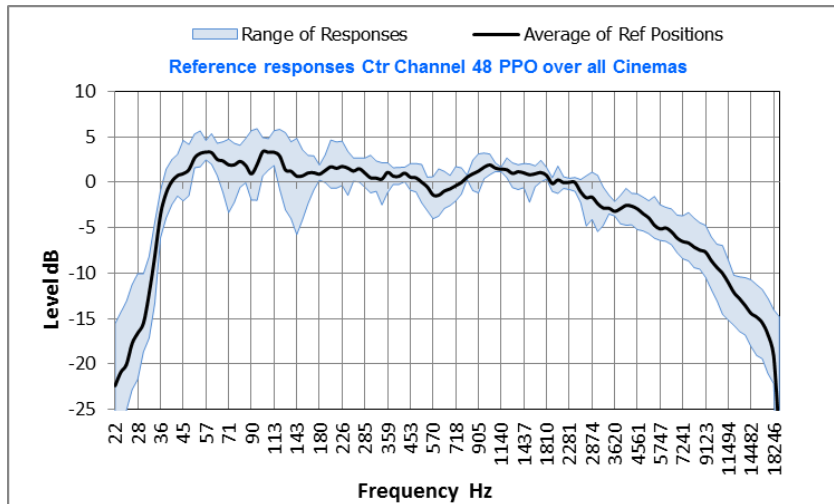

Overall average and range of responses at reference position for Center Channel of all cinemas smoothed over 1/3rd octave bandwidth with 48 PPO window. Responses were normalized before averaging.

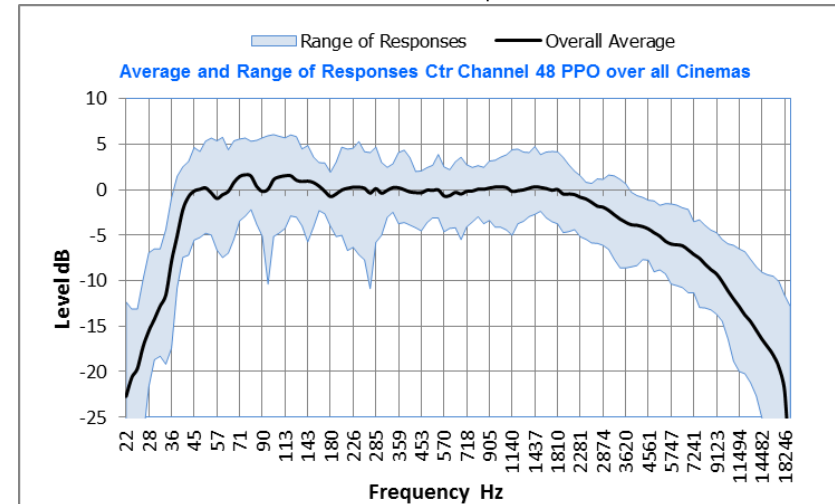

Overall average and range of responses over five positions for Center Channel of all cinemas smoothed over 1/3rd octave bandwidth with 48 PPO window. Responses were normalized before averaging.

Figure 25 - Frequency responses of Center Channel at the reference position, ranges of responses and overall average for the four cinemas

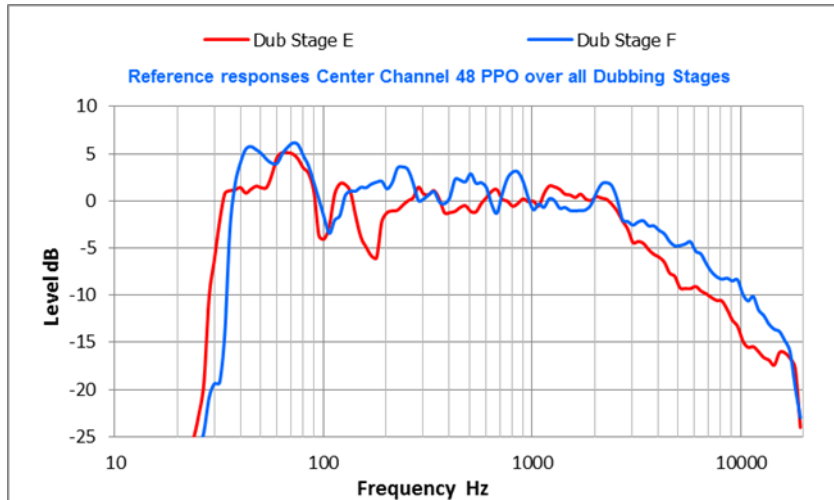

Responses of Center Channel at reference position of all dubbing stages smoothed over 1/3rd octave bandwidth with 48 PPO window. Response of each venue was normalized.

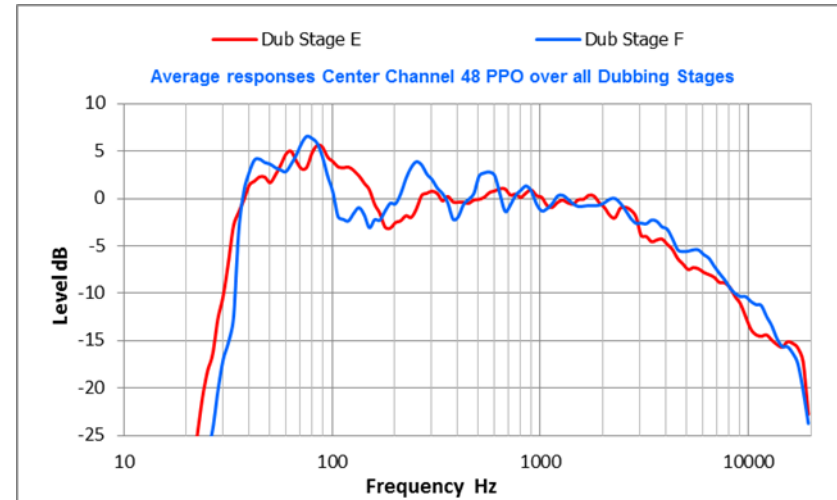

Average of responses over five positions of Center Channel of all dubbing stages smoothed over 1/3rd octave bandwidth with 48 PPO window. Responses normalized before averaging.

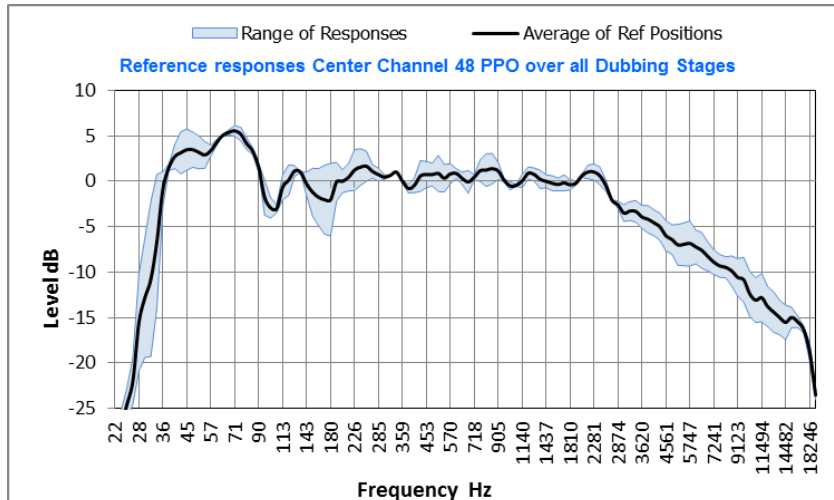

Overall average and range of responses at reference position for Center Channel of all dubbing stages smoothed over 1/3rd octave bandwidth with 48 PPO window. Responses were normalized before averaging.

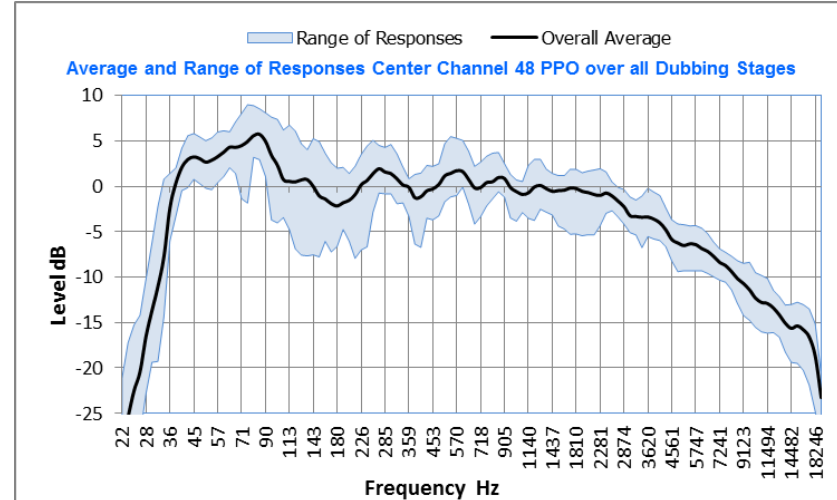

Overall average and range of responses over five positions for Center Channel of all dubbing stages smoothed over 1/3rd octave bandwidth with 48 PPO window. Responses were normalized before averaging.

Figure 26 - Frequency responses of Center Channel at the reference position, ranges of responses and overall average for the two dubbing stages.

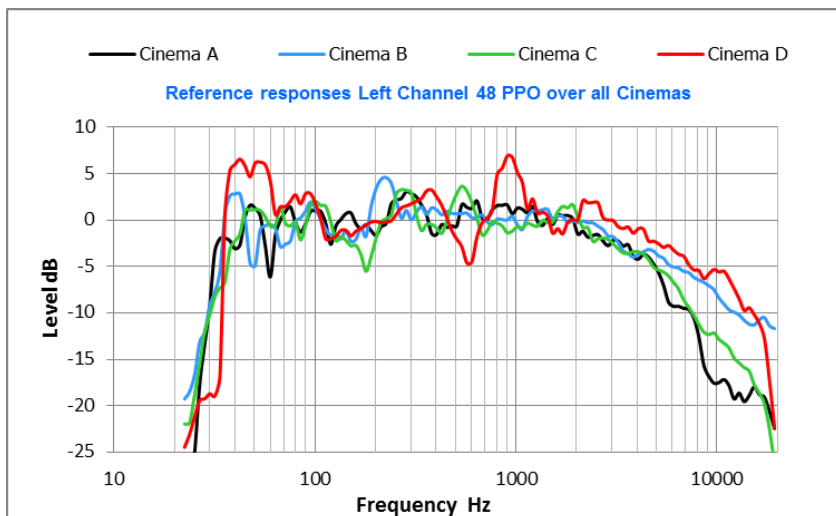

Responses of Left Channel at reference position of all cinemas smoothed over 1/3rd octave bandwidth with 48 PPO window. Response of each venue was normalized.

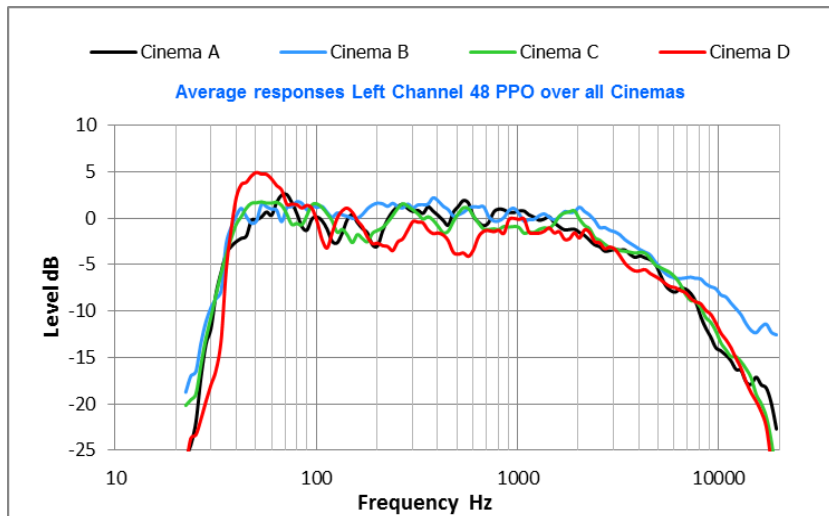

Average of responses over five positions of Left Channel of all cinemas smoothed over 1/3rd octave bandwidth with 48 PPO window. Responses were normalized before averaging.

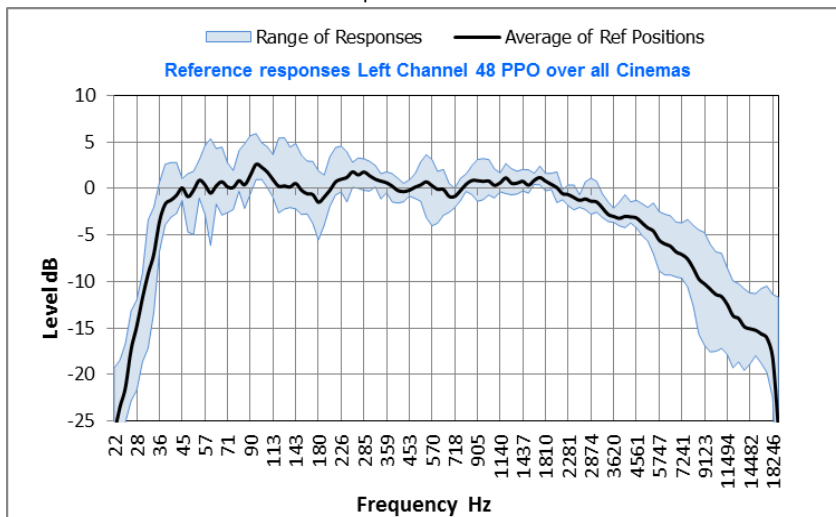

Overall average and range of responses at reference position for Left Channel of all cinemas smoothed over 1/3rd octave bandwidth with 48 PPO window. Responses were normalized before averaging.

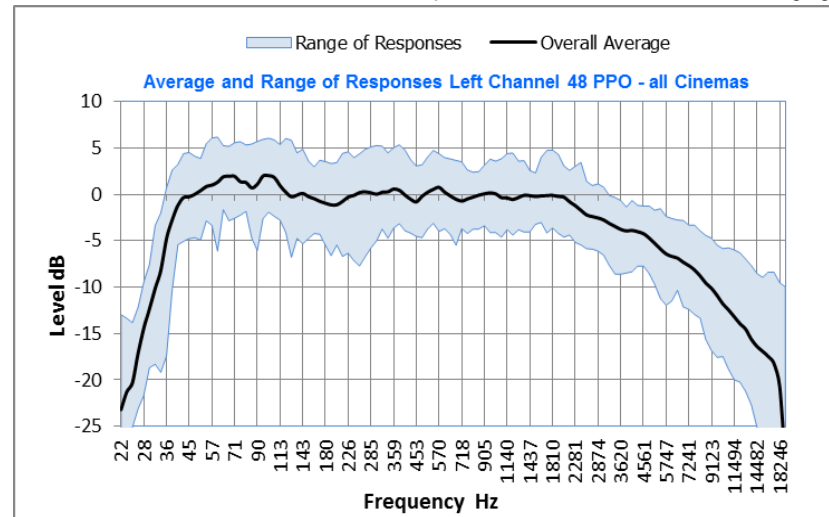

Overall average and range of responses over five positions for Left Channel of all cinemas smoothed over 1/3rd octave bandwidth with 48 PPO window. Responses were normalized before averaging.

Figure 27 - Frequency responses of Left Channel at the reference position, ranges of responses and overall average for the four cinemas.

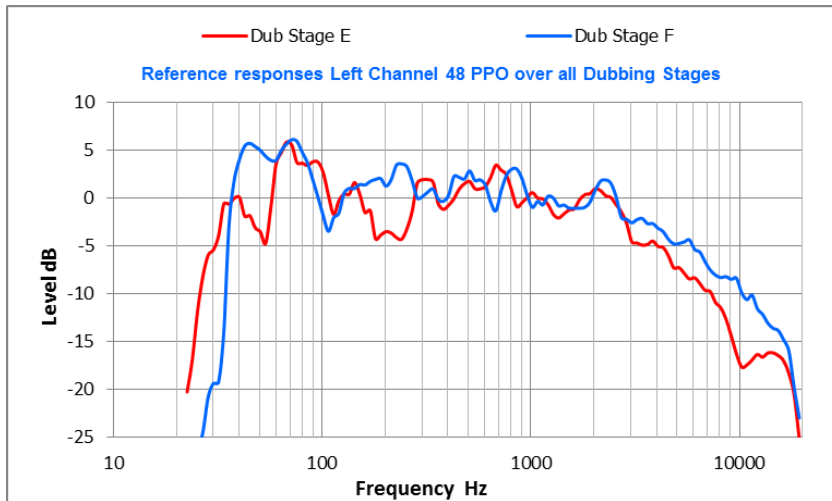

Responses of Left Channel at reference position of all dubbing stages smoothed over 1/3rd octave bandwidth with 48 PPO window. Response of each venue was normalized.

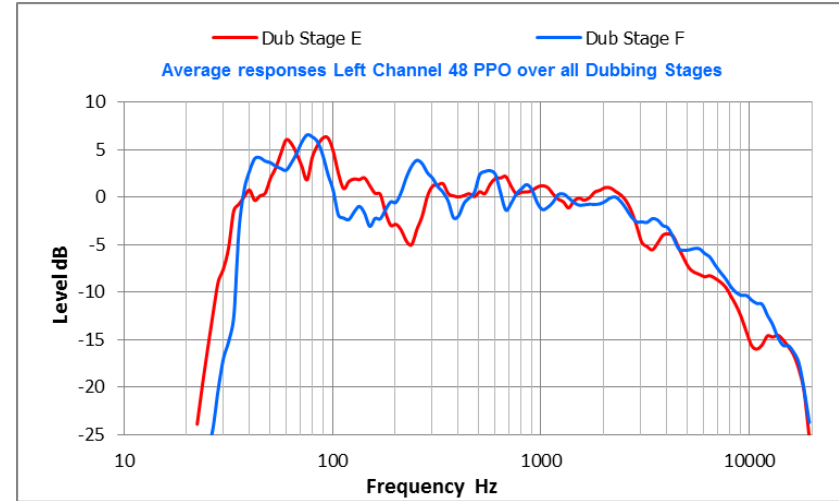

Average of responses over five positions of Left Channel of all dubbing stages smoothed over 1/3rd octave bandwidth with 48 PPO window. Responses normalized before averaging.

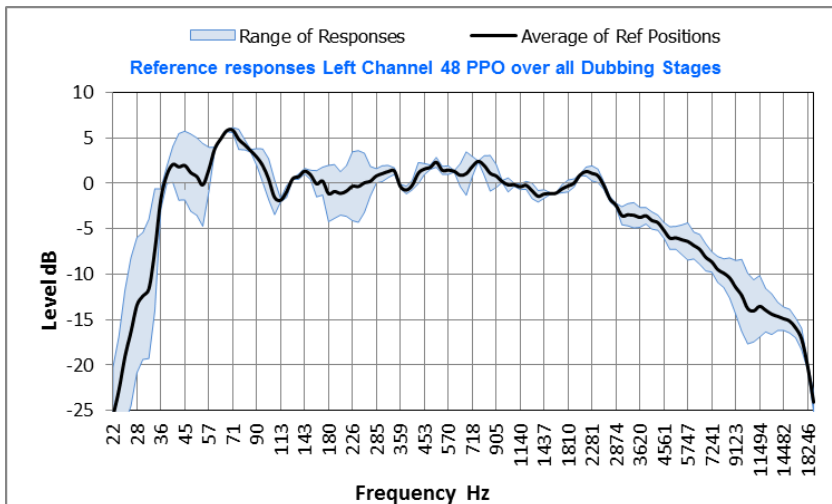

Overall average and range of responses at reference position for Left Channel of all dubbing stages smoothed over 1/3rd octave bandwidth with 48 PPO window. Responses were normalized before averaging.

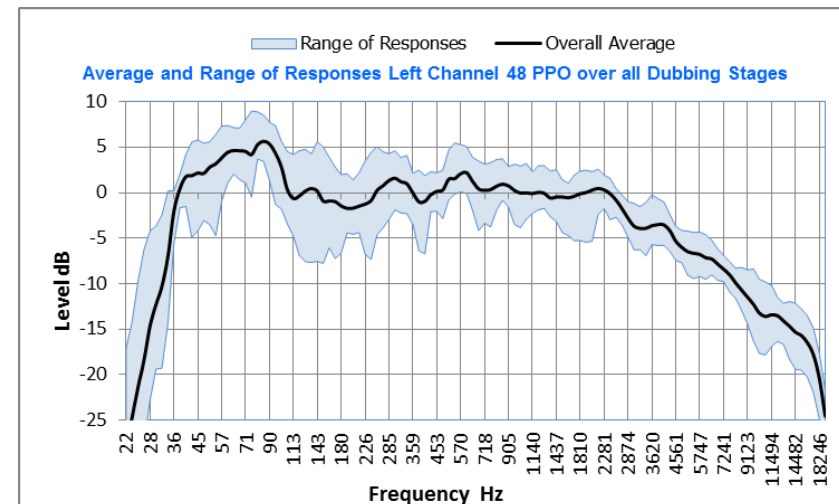

Overall average and range of responses over five positions for Left Channel of all dubbing stages smoothed over 1/3rd octave bandwidth with 48 PPO window. Responses were normalized before averaging.

Figure 28 - Frequency responses of Left Channel at the reference position, ranges of responses and overall average for the two dubbing stages.

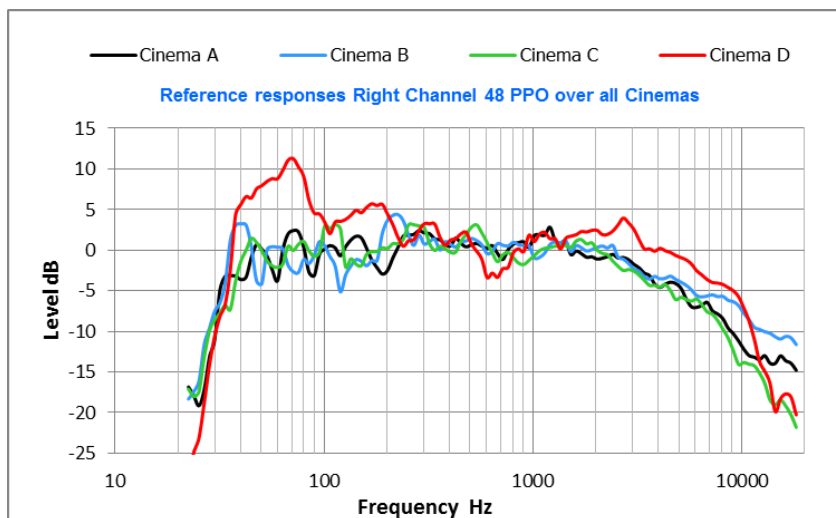

Responses of Right Channel at reference position of all cinemas smoothed over 1/3rd octave bandwidth with 48 PPO window. Response of each venue was normalized.

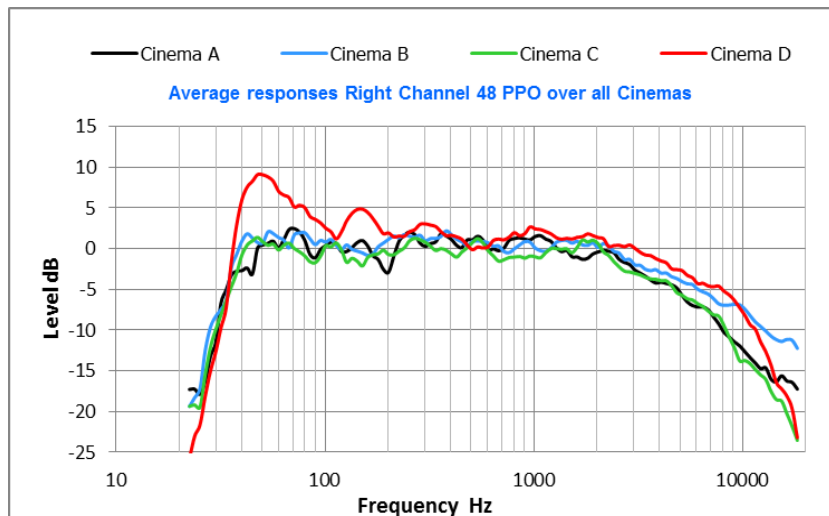

Average of responses over five positions of Right Channel of all cinemas smoothed over 1/3rd octave bandwidth with 48 PPO window. Responses were normalized before averaging.

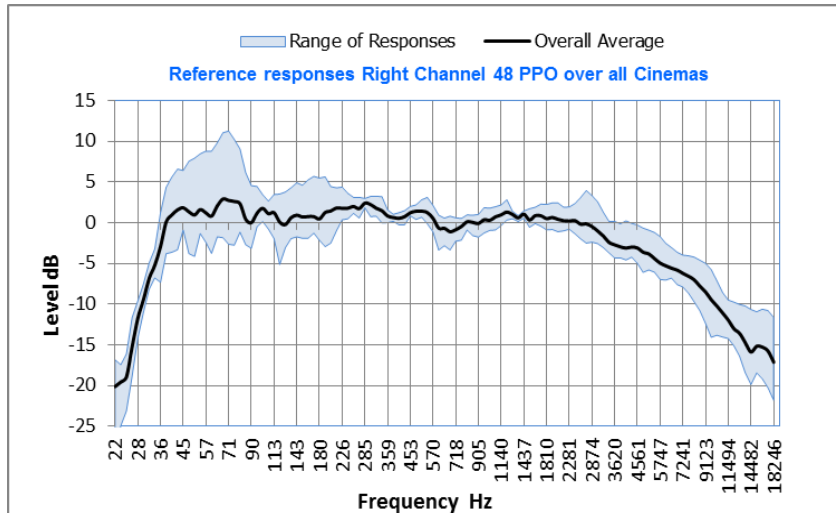

Overall average and range of responses at reference position for Right Channel of all cinemas smoothed over 1/3rd octave bandwidth with 48 PPO window. Responses were normalized before averaging.

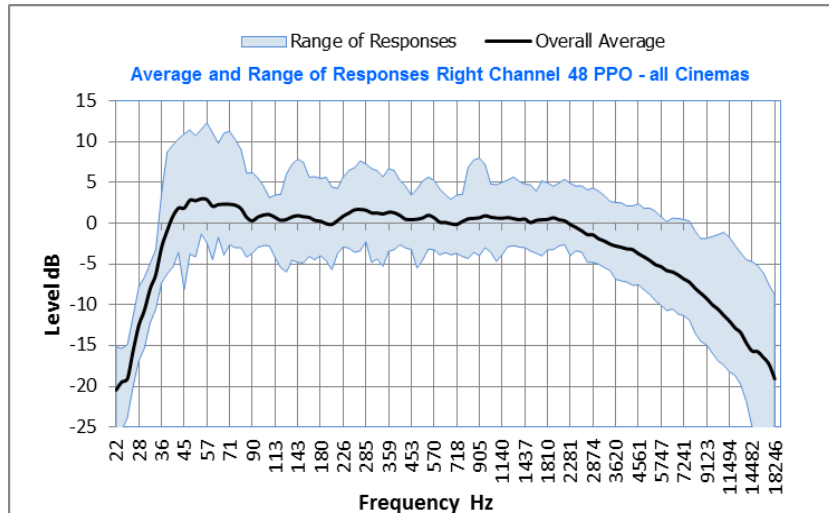

Overall average and range of responses over five positions for Right Channel of all cinemas smoothed over 1/3rd octave bandwidth with 48 PPO window. Responses were normalized before averaging.

Figure 29 - Frequency responses of Right Channel at the reference position, ranges of responses and overall average for the four cinemas.

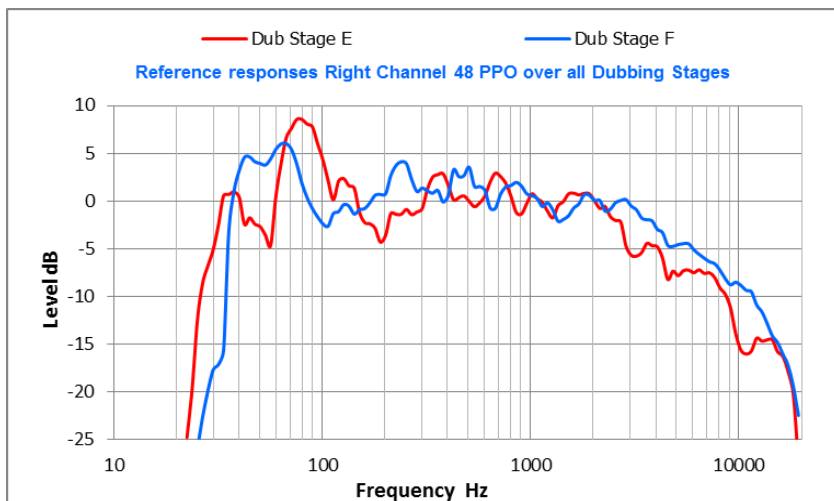

Responses of Right Channel at reference position of all dubbing stages smoothed over 1/3rd octave bandwidth with 48 PPO window. Response of each venue was normalized.

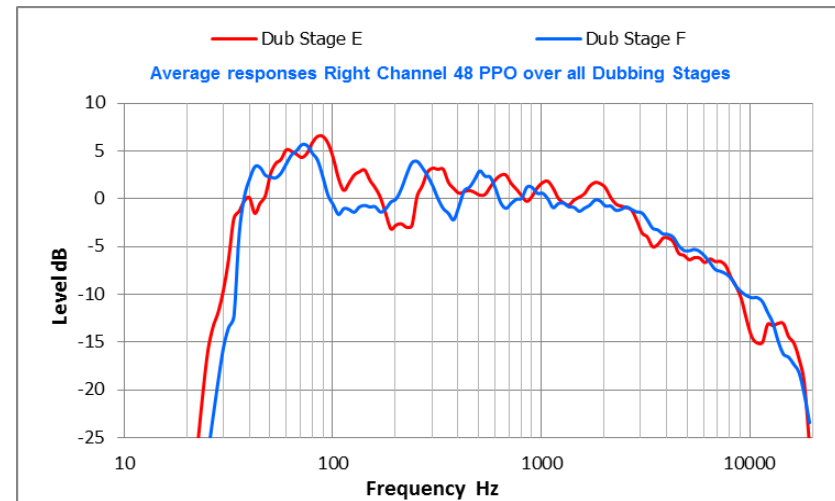

Average of responses over five positions of Right Channel of all dubbing stages smoothed over 1/3rd octave bandwidth with 48 PPO window. Responses normalized before averaging.

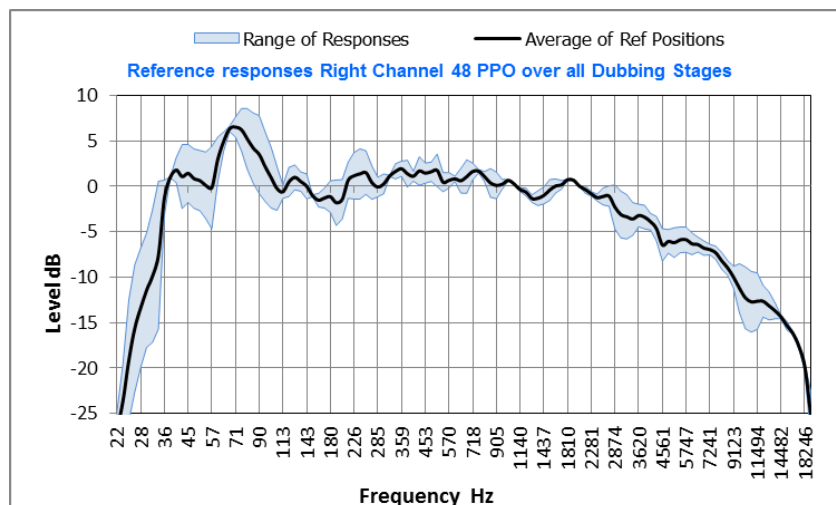

Overall average and range of responses at reference position for Right Channel of all dubbing stages smoothed over 1/3rd octave bandwidth with 48 PPO window. Responses were normalized before averaging.

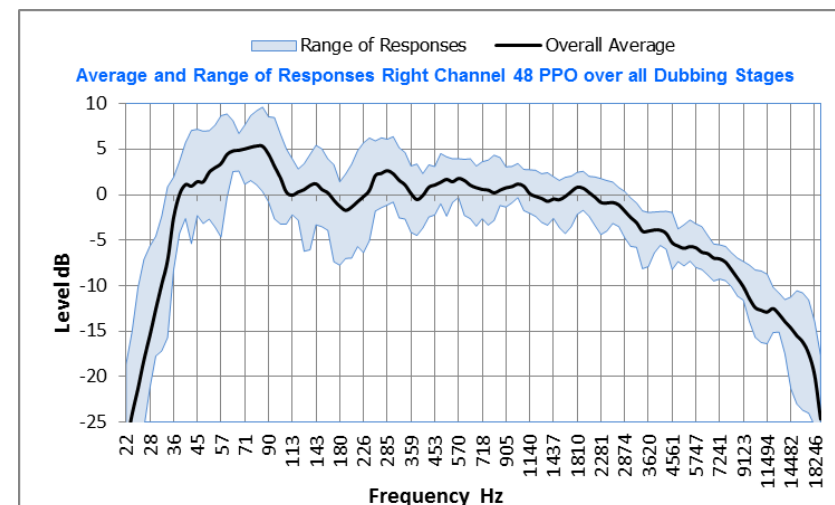

Overall average and range of responses over five positions for Right Channel of all dubbing stages smoothed over 1/3rd octave bandwidth with 48 PPO window. Responses were normalized before averaging.

Figure 30 - Frequency responses of Right Channel at the reference position, ranges of responses and overall average for the two dubbing stages.

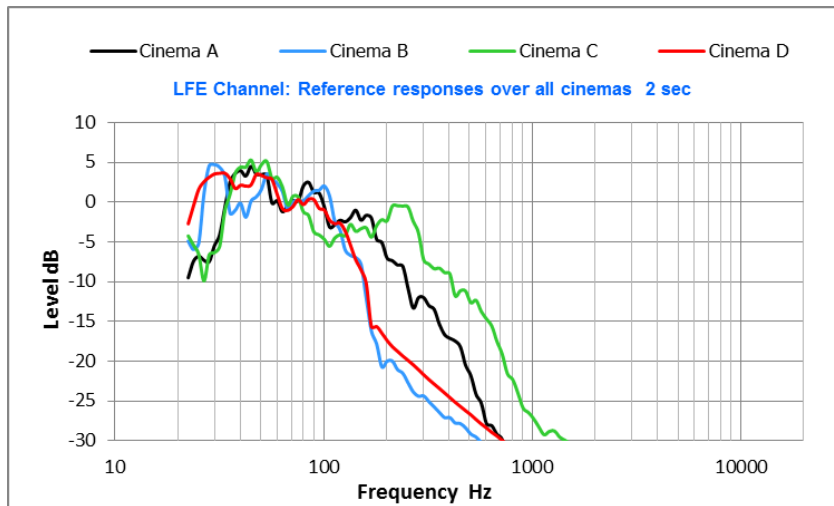

Responses of LFE Channel at reference position of all cinemas smoothed over 1/3rd octave bandwidth with 48 PPO window. Response of each venue was normalized.

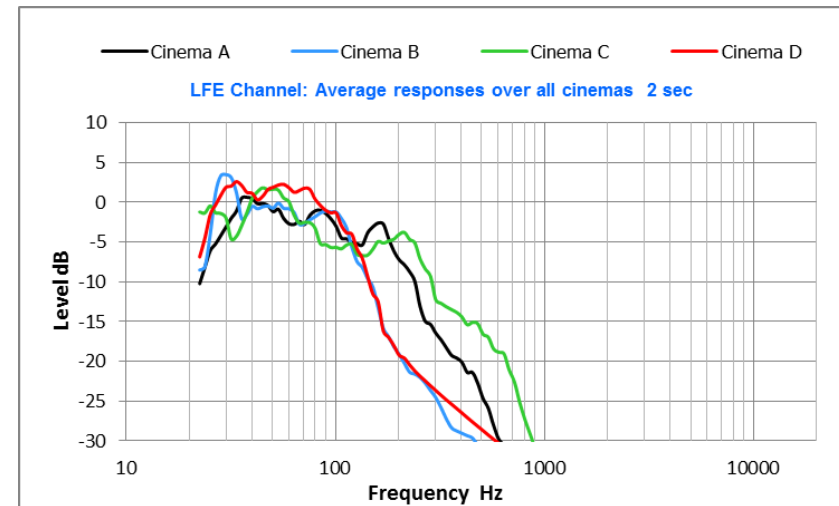

Average of responses over five positions of LFE Channel of all cinemas smoothed over 1/3rd octave bandwidth with 48 PPO window. Responses were normalized before averaging.

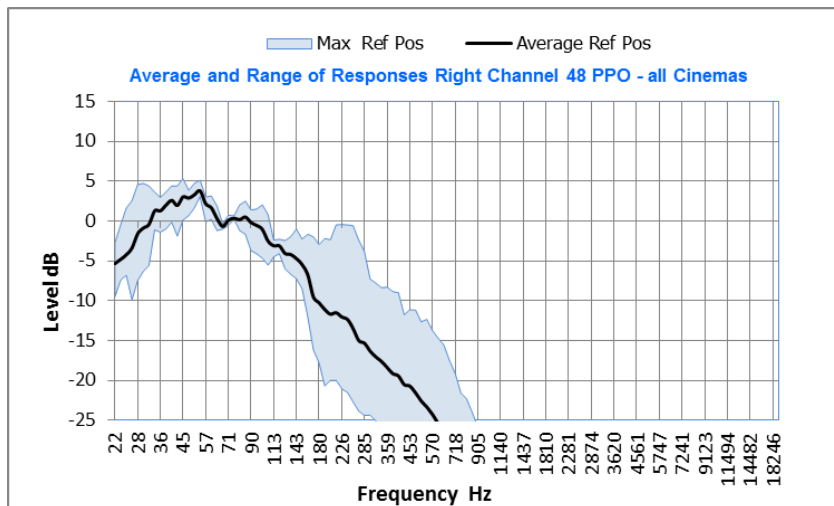

Overall average and range of responses at reference position for LFE Channel of all cinemas smoothed over 1/3rd octave bandwidth with 48 PPO window. Responses were normalized before averaging.

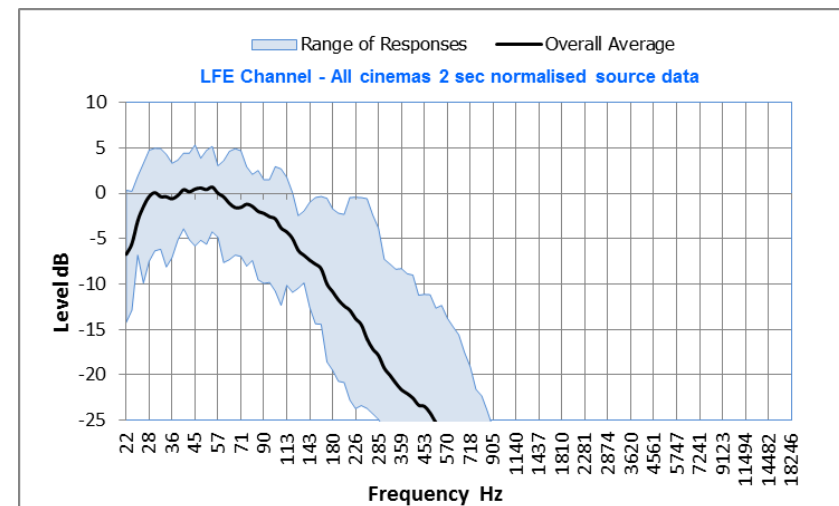

Overall average and range of responses over five positions for LFE Channel of all cinemas smoothed over 1/3rd octave bandwidth with 48 PPO window. Responses were normalized before averaging.

Figure 31 - Frequency responses of LFE Channel at the reference position, ranges of responses and overall average for the cinemas.

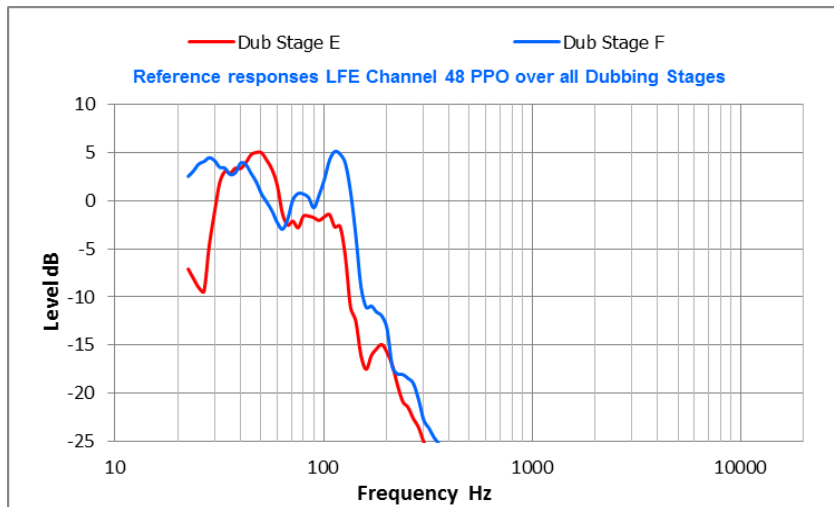

Responses of LFE Channel at Reference Position of all dubbing stages smoothed over 1/3rd octave bandwidth with 48 PPO window. Response of each venue was normalized.

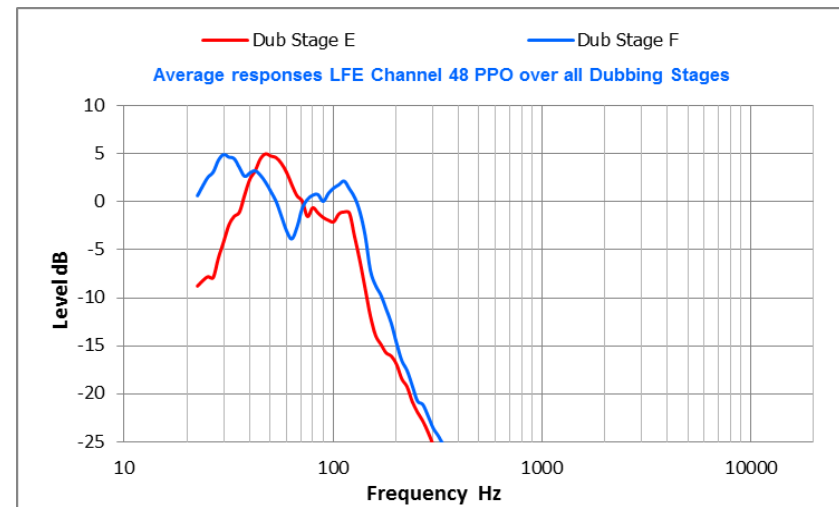

Average of responses over five positions of LFE Channel of all dubbing stages smoothed over 1/3rd octave bandwidth with 48 PPO window. Responses normalized before averaging.

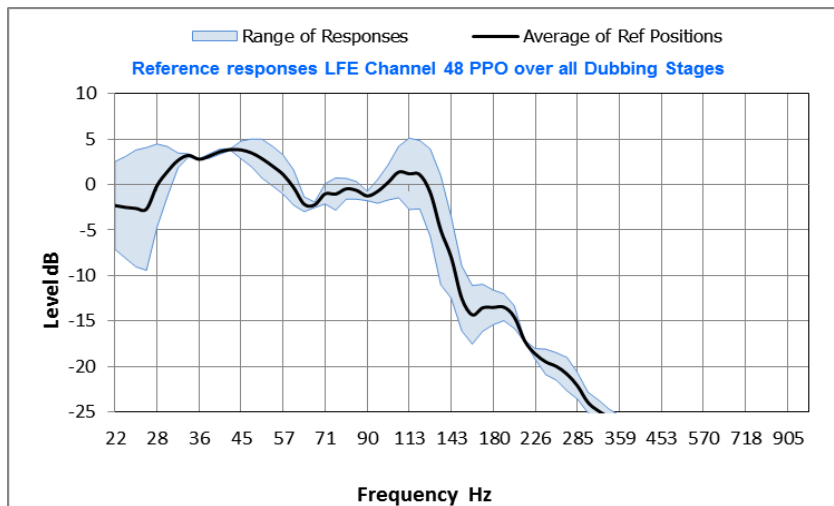

Overall average and range of responses at reference position for LFE Channel of all dubbing stages smoothed over 1/3rd octave bandwidth with 48 PPO window. Responses were normalized before averaging.

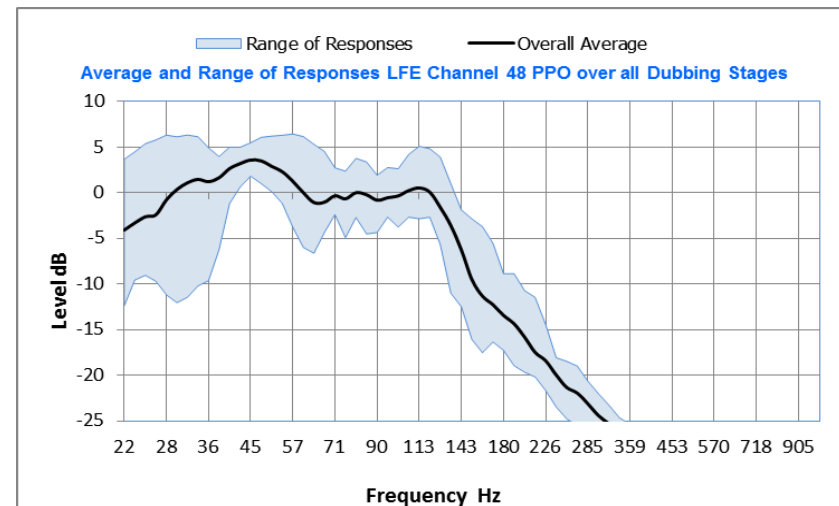

Overall average and range of responses over five positions for LFE Channel of all dubbing stages smoothed over 1/3rd octave bandwidth with 48 PPO window. Responses were normalized before averaging.

Figure 32 - Frequency responses of the LFE Channel at the reference position, ranges of responses and overall average for the two dubbing stages.

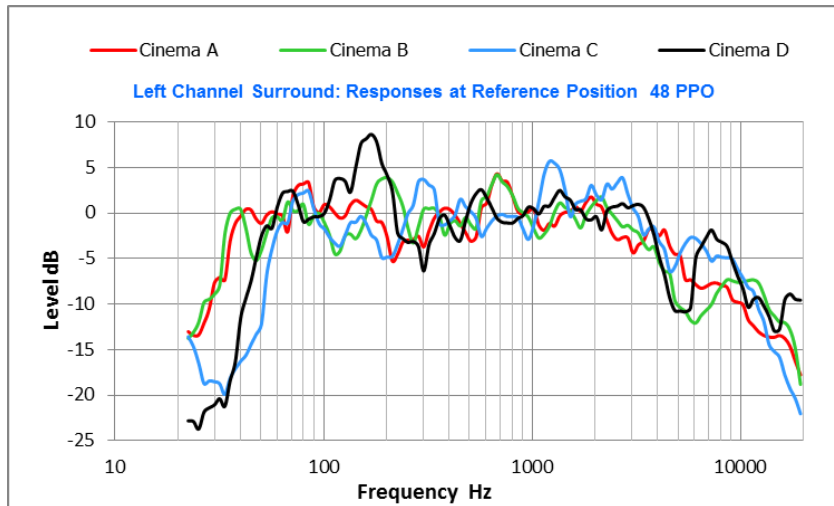

Responses of Left Surround Channel at reference position of all cinemas smoothed over 1/3rd octave bandwidth with 48 PPO window. Response of each venue was normalized.

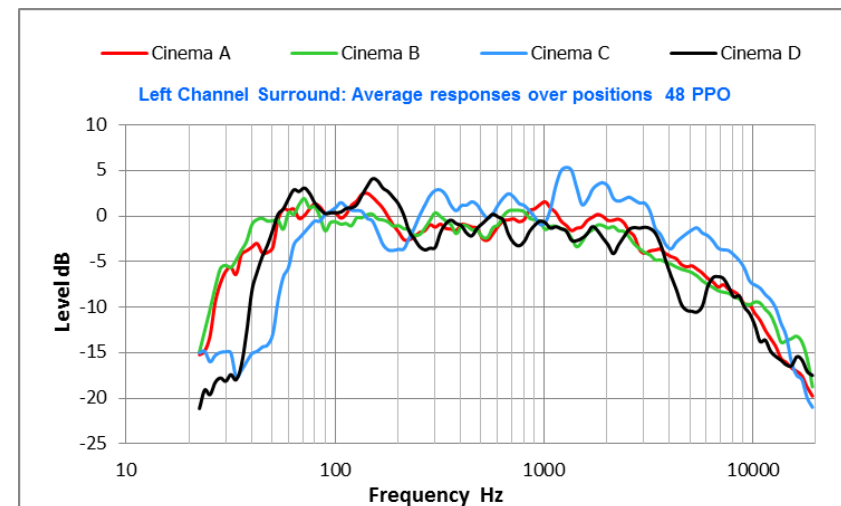

Average of responses over five positions of Left Surround Channel of all cinemas smoothed over 1/3rd octave bandwidth with 48 PPO window. Responses normalized before averaging.

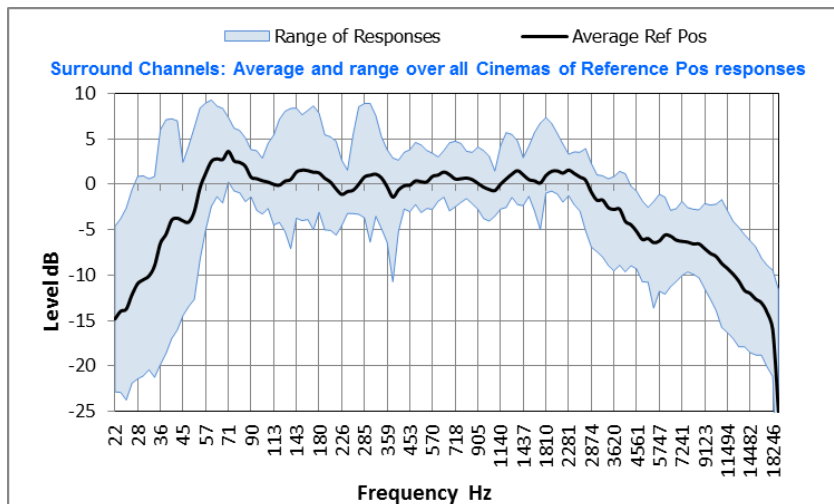

Overall average and range of responses at reference position for all surround channels of all cinemas smoothed over 1/3rd octave bandwidth with 48 PPO window. Responses were normalized before averaging.

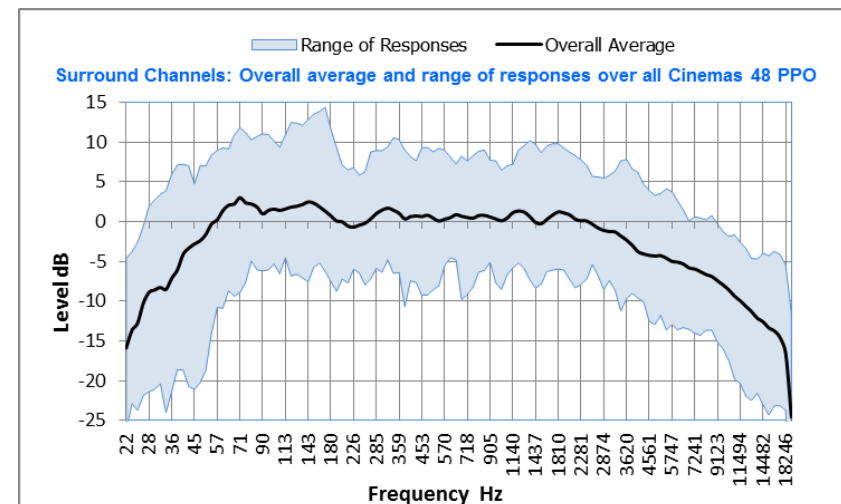

Overall average and range of responses over five positions for all surround channels of all cinemas smoothed over 1/3rd octave bandwidth with 48 PPO window. Responses were normalized before averaging.

Figure 33 - Frequency responses of a Surround Channel at the reference position, ranges of responses and overall average for the cinemas.

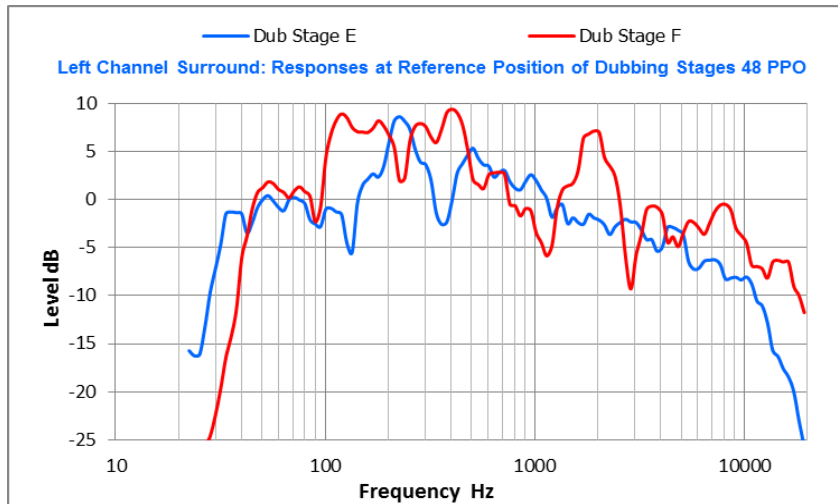

Responses of Left Surround Channel at reference position of all dubbing stages smoothed over 1/3rd octave bandwidth with 48 PPO window. Response of each venue was normalized.

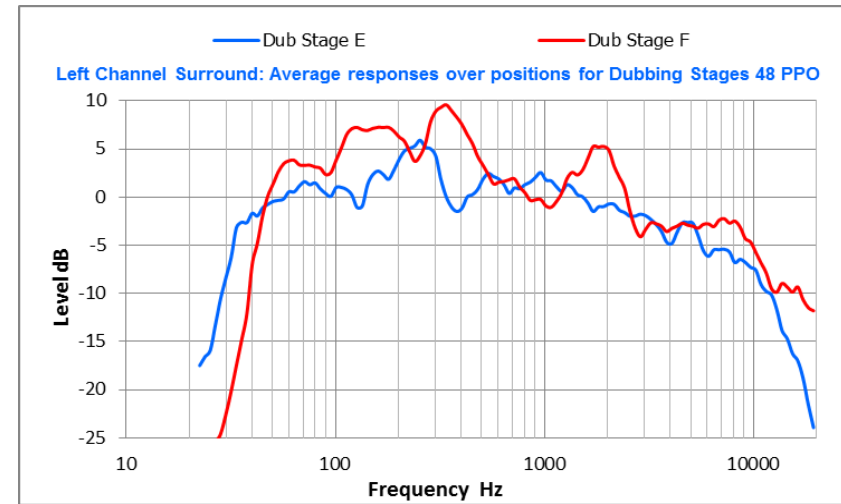

Average of responses over five positions of Left Surround Channel of all dubbing stages with 1/3rd octave smoothing 48 PPO window. Responses normalized before averaging.

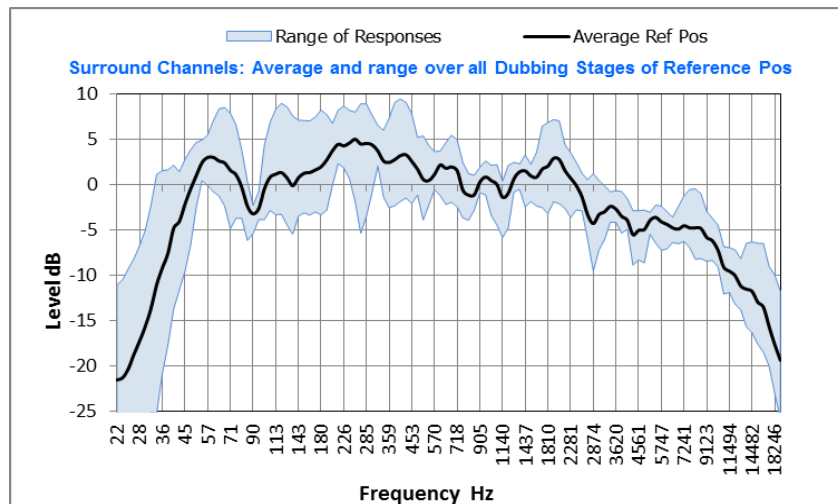

Overall average and range of responses at reference position for all surround channels of all dubbing stages smoothed over 1/3rd octave bandwidth with 48 PPO window. Responses were normalized before averaging.

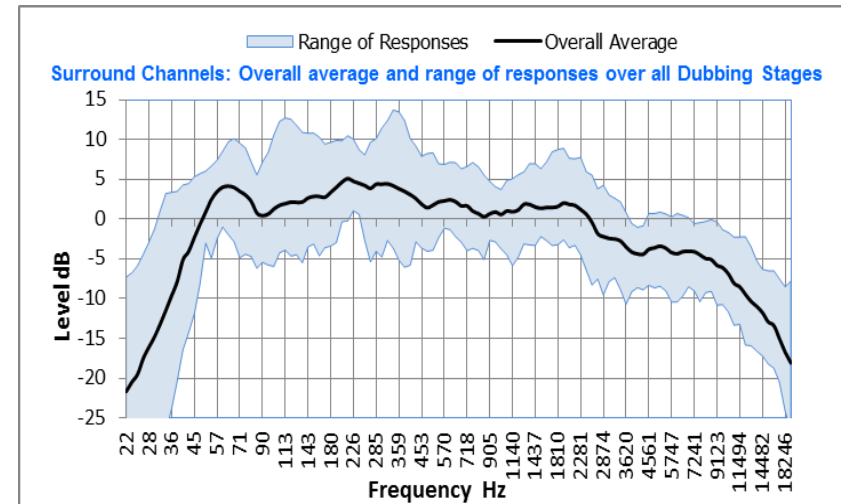

Overall average and range of responses over five positions for all surround channels of all dubbing stages smoothed over 1/3rd octave bandwidth with 48 PPO window. Responses were normalized before averaging.

Figure 34 - Frequency responses of surround channel at the reference position, ranges of responses and overall average for the two dubbing stages.

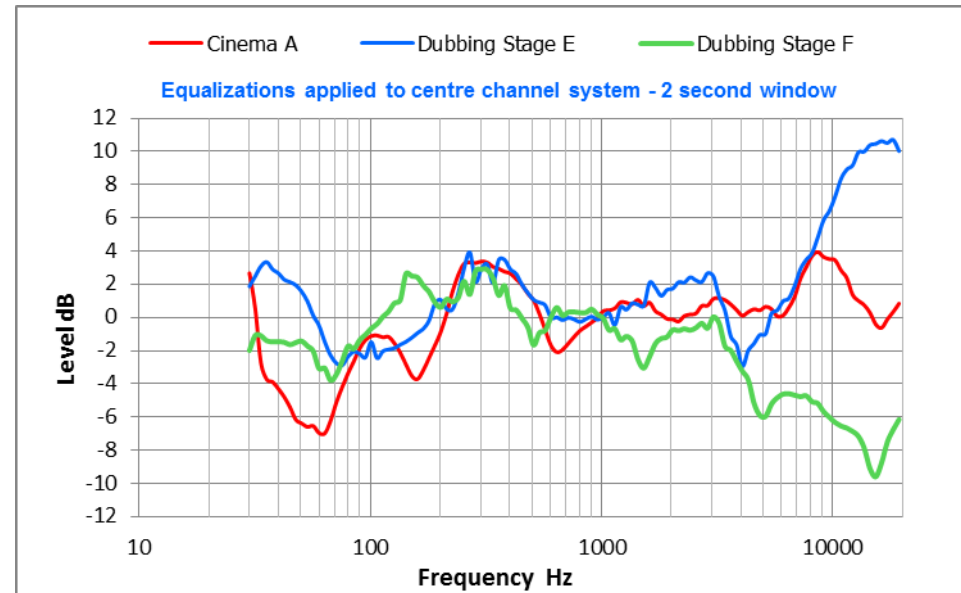

Figure 35 - Equalizations applied to Center channel system of three venues.

Responses were computed from the ratio of the measured responses with and without equalization at reference position with a 2 sec window.

13 ANALYSIS, CONCLUSIONS AND SUMMARY

This cinema sound report is the most comprehensive in-depth analysis of the cinema audio space ever published. The sheer volume of data that has been collected suggests that additional analysis may point to additional research or standards activities.

13.1 General Notes on the Testing

The “Zero Dark Thirty” testing crew comprised dedicated audio engineers, each with unique knowledge and hands-on experience in setting up and tuning sound systems. The quest for the information sought by the B-Chain Study Group led the testing crew to real-world exhibition theatres and dubbing theatres. Each theatre presented its own issues with regards to interfacing to the playback system, determining how to set the microphones for the space, how to connect the analyzers and the Pro Tools recording system, how to manipulate and equalize the B-chain, and host of other details that required discussion and cogent decisions. The time allotted for each testing period was limited, especially in the exhibition theatres, where the ZDT crew arrived before dawn and had to be finished and return the theatre to its running state prior to the first showing. The reference theatre and dubbing theatre testing allowed more time to obtain minute details, which would actually be the case when calibrating those theatres normally. Therefore, the testing conditions were quite representative of what a technician would be faced with when actually evaluating and tuning a sound system in these spaces.

Because of this, the data presented in this report is extremely valuable. It is not “laboratory” data, but is real-world data taken in commercial spaces. As such, it is representative of the true state of dubbing and exhibition theatres today.

In addition to the data that was gathered, this work allowed the crew to experience and document some pitfalls that can occur in the process of conducting measurements that are not “in the book”, but can lead to inaccuracies if not detected and corrected. These should prove valuable to technicians in the future, and are detailed in another section of this report.

13.2 Data Analysis

In each section, the range of data collected and the corresponding analysis of this data is very detailed. While this analysis may initially appear at first to be somewhat academic, the collection of these analyses and the ability to compare and contrast them with other measurements allows the report to convey overall trends in a revealing way. It is in this aspect where the value of this data collection is most valuable.

13.3 Screen Channels

- a) The biggest disparity in response comes at the frequency extremes, both low and high. It is interesting to note that one of the mix-rooms (Venue F) had negative high frequency equalization applied to the screen channels to meet the X-curve, and the other (Venue E) couldn't reach the curve even with high frequency boost applied. This may be partially caused by the performance characteristics of the particular high frequency drivers, but by far the biggest factor appears to be the acoustic characteristics of the screen as described in (23),(24),(25).
- b) The woven screen has definite advantages, which is the reason why the high frequency response was most extended in Venue F, as shown by its unequalized frequency response.
- c) At low frequencies there are even wider variations in the responses. Lack of overall low-end response is most likely due to poor loudspeaker response or incorrect equalization. Peaks and valleys are more likely due to location-specific room responses and attempts to compensate narrow band effects with system equalization.
- d) Equalization must be used judiciously in attempting to compensate for peaks and valleys, and is best implemented for those response errors that are minimum phase. The importance of good measurement

techniques, correct resolution and interpretation of the data in the low frequencies is paramount in achieving consistency.

13.4 Surround Loudspeakers

- a) While ST 202 discusses the optimum surround high-frequency characteristic, there is virtually no information about the expected low-frequency performance of surround loudspeakers, and it could be assumed that at low -frequencies the surrounds should perform identically as the screen loudspeakers. It is noted that in the early days of Dolby Digital, the surround loudspeakers were only required to be flat to 100 Hz, and no response was specified below 50 Hz.
- b) The measured LF response cut-off frequencies of the surround channels range from 30 Hz to 60 Hz.
Until recent years many theatres utilized surround speakers with 8" low-frequency drivers, which are manifestly unable to match the screen characteristic. Sensible mixers took account of this, and avoided putting significant low frequency energy in the surrounds. Similarly, good installers would avoid trying to equalize the low-frequency response up, leading to overload (if not sudden death). As some theatres and most mix-rooms started using better surround speakers, the variations between good and bad became more pronounced, as can be seen in the six venues here.
- c) ST 202 does discuss a slight adjustment of high-frequency characteristic of the surround speakers depending on room shape, room volume etc. Within reason, provided the characteristic in the mix-room matches that in the playback theatre, the actual high-frequency characteristic is academic to a certain extent. But the response data presented in this report shows that there are significant differences between the high frequency responses of these venues, for which the reasons are unknown. These differences are likely to be audible. We note however, that no performance specifications (frequency response, coverage, etc.) exist for any channel in a cinema.
- d) The direct-field component of the sound produced by the surround channels will be subject to strong phase interference effects, due to the multiple loudspeakers. As the difference in paths lengths from each speaker to a given listener can be quite small, the bandwidth in Hz of the phase cancellations and peaks can be quite wide at mid and low mid frequencies, there will be noticeable changes in tonality with position over the listening area.
- e) As the average response represents only five positions, it may or may not be representative of the total listening area. It is possible that at low and low mid positions, the differences between the speaker-to-listener path lengths are sufficiently similar to create a common set of phase cancellations/boosts that would affect the average of the five positions. However, if many more positions were used for the average, the average would largely reflect the power response of the loudspeakers, and these response anomalies would be smoothed out.

Not all response anomalies seen in the average of five responses can be attributed due to phase interference effects. For example, for a wide depression at 3.5 kHz to appear in the average response of five positions would require the differences between all speaker-to-listener path lengths to be approximately 50 mm. This situation is highly unlikely, and therefore these types of response anomalies must be attributable to other effects, such as the intrinsic loudspeaker response or equalization.

13.5 LFE Responses

- a) The widest variations are in the LFE responses. There seems to be little consistency in the LF extension of any of the channels.
- b) There was clear evidence of a significant difference in the low-frequency response extensions when comparing the different theatres. These low frequency limits were approximately 30 Hz, 35 Hz, 40 Hz, 50 Hz, 55 Hz and 60 Hz, which covers a whole octave. In some cases, the response only extends mostly flat to 40 Hz, whereas a more typical -3 dB point for modern cinemas would be 25 Hz.
- c) At the higher frequency end of the LFE responses, theatres A and C showed higher cutoff frequencies and shallower roll-off rates than for the other four theatres.
- d) A number of the average and reference position responses of both cinemas and dubbing stages show boosts of up to 5 dB with notable bandwidths.

- e) ST 202 states that the sound track itself has a steep low pass filter cut-off at 120 Hz. If this low-pass is *not* applied to the sound track, then the LF loudspeaker response in the playback theatre becomes the low pass filter. Accordingly, the wide disparity between the six venues measured would result in significant audible differences in the region above 120 Hz.

This highlights the need for a performance specification that clarifies whether high pass filtering to meet the required LFE spectrum should be done in the mixing stage or in the loudspeaker system.

If this filtering is only provided by the loudspeakers' intrinsic response, out-of-band signals can be allowed into the mixes that will be audible on systems with out-of-band responses.

13.6 Low Frequency Response and Source Summation

- a) The LF responses of the screen channels exhibit roll-offs beginning at different frequencies, and also exhibit different slopes.
- b) There was clear evidence of a significant difference in the low frequency response extensions in the different theatres. The roll-off points of the LFE channels vary from 20 Hz to 40 Hz, with those of the surround channels ranging from 30 Hz to 60 Hz. The screen channels showed somewhat more consistency, generally only varying between about 30 Hz and 40 Hz, but their responses did also exhibit different roll-off slopes.
- c) Unexpectedly, the average of both dubbing stages shows a boost of up to 5 dB between 60 and 90 Hz whereas the average response of the theatres much flatter in this region.
- d) The roll-offs on the surround loudspeakers of the individual theatres began at 30 Hz, 35 Hz, 40 Hz, 50 Hz, 55 Hz and 60 Hz, which covers a whole octave. Some theatres show boosts of up to 5 dB in the 50 to 90 Hz band, and one theatre exhibits a dip in the 130 to 200 Hz region that appears to be loudspeaker related as it appears in various microphone positions. These results suggest that the allowable LF tolerance in ST 202:2010 is being fully exploited, and also imply that significant differences in the perceived low-frequency responses are to be expected, especially given the closeness of the equal-loudness curves below 60 Hz.
- e) Even industry experts do not agree on the "proper" use of the LFE channel and whether cinema systems should employ any form of bass management; i.e. the LFE loudspeakers are always driven by a discrete LFE channel. This report assumes that in all normal theatrical installations, the LFE loudspeakers are never used in conjunction with a screen channel (L, C and R) in a bass management arrangement. As noted, some channel sharing of low frequency information may be applied in the mix room, so finding an optimum phase and polarity for LFE and screen channels is nonetheless required. It would have been interesting, if time had allowed, to have measured the relative phase responses of the LFE and primary screen loudspeakers.
- f) One reason for the variability in combined LF responses from installation to installation is that there is no standard for the phase relationship between the screen and LFE loudspeakers. Furthermore, the summation of any combination of loudspeakers is not consistent over the audience area. Despite this, mixers do often use various combinations of channels to gain additional LF power.
- g) It is a matter of guess work for the mixers as to how summed low frequencies will sound in environments other than the ones in which each soundtrack is mixed. For the purposes of this report, efforts made to measure combined LF responses would have been futile. A performance specification to resolve this situation is required.

13.7 Mid and High Responses

- a) It is apparent that, in all six theatres tested, a 'Standard' X-curve has been applied via equalization to the screen and surround channels in the form of a target curve, irrespective of the screen types or room sizes or reverberation times of the different theatres.
- b) Although there are notable differences in the high frequency responses of the Center Channel at the reference position between all six venues, the average responses of the Center Channel for all venues are quite similar, and lie within a window of 3 dB.

- c) In all venues, the responses of the 10 ms, 50 ms, 48 PPO and 2 second windows are remarkably similar from approximately 800 Hz up. This indicates that the direct field strongly dominates the measurements, and that reverberant build-up contributes only a small amount of sound to the total energy at these frequencies, even deep into the rooms. This behavior is strongly similar to the cinema measurements described in (4).
- d) The responses of the close-field microphones and the averaged close-field response of the reference cinema are far from flat. In general, the responses of the close field microphones above 1 kHz show strong similarity with both the reference position and average responses. There is a little more high frequency energy in the close field responses, which is consistent with the loss due to air-absorption as the sound travels to the audience area. In other words, the close-field microphones essentially show an X-curve with a little more high frequency response, corroborating the results shown in (2).
- e) One component of the change in frequency response described in (8), apparently due to the effect of the reverberant field clearly does not occur here. There is nothing to suggest that the X-curve as measured in the room is a measurement artifact resulting from reverberant buildup; i.e. an artifact resulting from steady-state measurements of typical cinema acoustics.
- f) Where deviation from the X-curve is evident at high frequencies, it is generally manifest as an increased roll-off.
- g) There appears to be poor consistency between the six sets of venue measurements with respect to room sizes, reverberation times and high-frequency roll-offs. Two of the venues meet the X-curve target, but four show signs of falling significantly below it.

13.8 Close Field Responses

- a) While the close field measurements are interesting, they have provided limited quantitative information, primarily due to the lack of detailed information about loudspeaker types, sizes and locations in all but Venue F. Drawing conclusions from this data must be done with caution.
- b) In Venue F, the three microphones were based on accurate drawings of the location of the transducers in the Center Channel. It is therefore particularly noteworthy that the close-field responses are much more aligned with those of the audience area than with the other venues with close-field responses.
- c) Compared to the audience responses, the close field responses generally show slightly less roll-off as the frequency increases. This is consistent with air-absorption losses that increase with frequency and distance and therefore affect the audience microphones far more than the close field. At 10 kHz and 20° C with 50% Relative Humidity, the attenuation over a distance of 10 m would be 1.9 dB.
- d) The primary difficulty is that being so close, no single microphone location could provide a definitive measurement, so the intention on site was to obtain an average of a number of measurements that might be useful at mid-to-high frequencies - not low frequencies. As highly detailed knowledge of the loudspeaker directivity, size and the exact locations of each driver were not available (other than Venue F), individual measurements would always be open to question.
- e) We also investigated whether microphones can provide valid calibration information. Our investigation indicates they can, but only if they are positioned in a repeatable manner and located in a known and suitable relationship relative to the configuration of the loudspeaker system. Among the factors that must be understood when positioning the microphones are; i) the location of the microphones relative to the axis to each driver, ii) the inter-transducer distances to the microphone, iii) crossover points and iv) transducer directivity.
- f) Certain characteristics of the measurements can be assessed with confidence if they appear in all three three microphone responses. Clearly, there is much commonality between the plots in terms of the HF and LF roll offs.

Note that this would not be the case if there were significant geometrical effects due to excessively off-axis positioning. Consequently it can safely be concluded that these roll-offs are real.

13.9 Temporal Responses

- a) The reverberation time plots show generally smooth behavior, with some venues showing much higher reverberation times at low frequencies compared to mid frequencies. It noted that at 500 Hz, the RTs ranged from 0.23 s to 0.72 s, and at 63 Hz from 0.30 s to 1.95 s. At 8 kHz, however, the range of variation was only from 0.27 s to 0.51 s.
- b) The Schroeder plots of the six rooms all show respectably straight decay lines indicating that there are no apparent problems with coupled spaces or very strong reflections. Reverberation from coupled spaces, such as occur in the larger old theatres, will demonstrate different periods decay and result in a Schroeder plot with dual decay slopes.
- c) In two of the three venues where three measurements were made, there is some evidence from these measurements that the low frequencies may have been partly equalized-out of the direct sound (as measured at close distance) to compensate for the reverberant build up in the room.
- d) Although the cumulative energy plots must show an overall correlation with the reverberation time, the presence of a strong reflection can temporarily increase or decrease the build-up of energy, depending on the phase of the reflection relative to the direct field. In addition, if the loudspeaker directs much of its energy at a highly absorptive surface in an otherwise live space, the CE plot will show a rapid increase to near its final value, and then a slow increase to its final value.
- e) The cumulative energy (CE) plots are quite revealing of two aspects in a number of the venues:
 - o the impact of strong reflections of the sound at all frequencies as it develops in the room
 - o the protracted time for frequencies below 250 Hz to develop.

Both of these aspects have the potential for negative impact on the subjective sound quality.

- f) Venue E shows a delayed energy build-up in the 250 Hz bands that does not correspond to the low reverberation time in this frequency range. This is due to the presence of one or more strong reflections that partially cancel the direct field, which was evident in the frequency response plots with a 50 ms window.
- g) Although the RTs at 125 Hz and 250 are somewhat similar for Venues A, C and D, the cumulative energy is delayed substantially in Venues A and C, compared to that of Venue D.
- h) Of the cinemas, Venue B generally shows the most rapid cumulative energy build up at all frequencies.

13.10 Effect of cinema screens

- a) Analysis of the data in this report shows that the measurement process was not the reason for the high frequency roll-off shown by the loudspeaker and that air-absorption was only responsible for minor losses only. The remaining factors that can cause the roll-off of high frequencies are the cinema screen, loudspeaker responses and equalization.
- b) Long, Schwenke, Soper, and Leembruggen show in (24), which is confirmed by Newell et al in (25), a perforated cinema screen is an acoustic low-pass filter, whereas a woven screen is a broadband attenuator with a loss of no more than several decibels. This behavior was previously reported to SMPTE by Eargle, et. al., in (23) and Holman in (26).
- c) Reference (24) also shows that the high frequency response of a perforated screen is directly related to the percentage of open area, hole size, and material thickness, while for a woven screen, the response is related to the flow resistivity of the material.
- d) The high acoustical impedance that the perforated screen presents to the loudspeaker will result in successive reflections of sound between loudspeaker baffle and screen; a type of flutter echo. Reference (24) shows evidence of these reflections in the measured anechoic responses of a loudspeaker/screen system.
- e) Harshness or high-frequency aggressiveness of sound is sometimes attributed to the screen, but may in fact be simply due to the high frequency drivers being driven hard in an attempt to overcome the low pass filter action of the screen.
- f) There is current debate about the audibility of these reflections:

- The high degree of time-smearing resulting from these successive reflections suggests that they should have some audibility.
- As the effects of phase cancellations can extend relatively low in frequency, some effects would be anticipated to be audible as they affect the overall response.
- Although the measured HF response with EQ in Venue F looks similar to the other venues, the listening test showed that this venue had more detail and clarity than the other venues. Although Venue D had the same loudspeakers as Venue F, its perceived sound was not as detailed as Venue F. Noting that Venue F has a woven screen, a possible conclusion is that the reduced phase interference effects of the woven screen (compared to the perforated screen) make an audible improvement.
- More research and discussion on this subject is needed in order to determine the audibility of these reflections. As the time of writing, a research project on the subject is underway in the UK.

13.11 Current Deficiencies

A number of important factors have been identified that contribute to frequency response variations between venues.

- a) ST 202 is deficient in discussion of tolerances

It is apparent from the measurement results that SMPTE ST 202 is deficient in discussion of tolerances. Most of the measurements sit within the existing SMPTE ST 202 tolerance window, but the significant variations, especially at low frequencies, are likely to indicate important audible differences.

- b) The individual technician's interpretations of how SMPTE ST202 should be applied will lead to variations.

- c) The installers' technique in using the measurement equipment will also lead to variations.

The cause for this is a deficiency in education, which may be due to some technicians essentially being self-taught, and idiosyncratic in their measurement method.

- d) Different technicians use different approaches to the application of equalization. It has been shown, elsewhere, that ten technicians given the same room to calibrate can result in ten different equalization settings, with all fitting within the +3 dB tolerance window of SMPTE ST202. This can produce very different sounding systems.

13.12 Answers to Study Group Questions

- a. *Effect of using test signals other than wideband pink noise:*

In dubbing stage E, each electroacoustic measurement was carried out using pink noise and swept sine test signals. Section 8.7 presents comparisons of the pink noise and swept sine signals, and shows that the results are remarkably similar. However, for a number of important reasons, the swept sine signal proved much better. These reasons include audibility checks of system issues such as distortion, rattles and reflections and far greater ratio of signal to ambient noise.

- b. *Determine if different analysis techniques produced results that were more consistent and useful than the 1/3 octave real time analyzer (RTA) technique described in SMPTE ST 202. Determine the difference between the "time-blind" 1/3rd octave-band RTA, single-channel, high-resolution using FFT calculations and "time-smart", dual-channel analyzers that use the system impulse response to derive the frequency response:*

Section 8.6 compares the RTA and transfer function measurements, based on the impulse responses. Section 8.6.2 shows graphs of two cinemas for Center, LFE and Left Surround, each comparing RTA to transfer function. The general shapes are consistent, which is good, but looking closely reveals that the transfer function gives more amplitude detail. It also shows more stable measurements in the low mid and bass frequencies.

- c. *Determine the effect of system equalization both on measured response and aural perception:*

The prior sections discuss the overall responses in the high, mid and low frequencies for the venues tested; this section looks at some specific effects of the system equalization.

Venues A, E and F were tested with the “as found” system equalization and “EQ bypassed” for Center, LFE and Left Surround. Venues B, C and D were only measured “as found”.

For the screen channels in Venues A and E, when the EQ was bypassed the high frequency response was well under the X-curve, so high frequency EQ boost had been applied in an attempt to bring the frequency response up to the X curve as shown in Figure 35. Listening tests confirmed the lack of high frequency response when EQ was bypassed in Venue E, but it appeared in Venue A that the aural effect was subtle. It was discovered that Venue A had an additional “screen compensation” high frequency boost applied after the system EQ in the signal path that was not able to be bypassed.

So, while it appears from Figure 35 that the EQ applied to Venue E was much greater than Venue A, the additional screen compensation equalization likely made the amount more similar. Even with the EQ applied, Venue A barely makes the X-curve and Venue E falls far beneath the X-curve on the high end by measurement. The listening tests indicated that these venues lacked “sparkle”, but neither were considered “dull”. The group felt that Venue E sounded somewhat strident on loud material but not on average level material, and thought that this was perhaps because the large amount of high-end EQ lowered the headroom or was causing distress to the high frequency driver.

As noted above, the situation is the opposite with Venue F. The measured HF response with EQ bypassed is much flatter at the high end. The major difference in this room from the others is the woven screen, and this will be the largest contributing factor. Presumably in order to more closely resemble the X-curve, cut EQ was applied at high frequencies, and the measurement result is somewhat similar to Venues A and E after EQ.

Listening tests with cinema soundtrack material indicated that although the sound in Venue F was quite bright without EQ, it was not strident or difficult to listen to. Even with the EQ as applied that brought the measured response closer in line with Venues A and E, the sound was much more detailed and revealing than Venues A or E. This indicates that the measured high frequency response does not tell the whole story regarding human perception, and that systems with similar measured responses may in fact sound quite different.

In the midrange frequencies, the group observed that Venue A had a fair amount of “roller coaster” EQ applied on the cinema processor, presumably in an attempt to bring it closer to flat response. The group was not able to view the EQ applied in E and F, but Figure 35 indicates that it was not as extreme in the midrange. For the low end, Venue A has a cut applied in the low end around 70 Hz to account for a measured rise there, likely due to room buildup, whereas E has boost around 40 Hz. Group listening tests indicated that in Venue A with the EQ bypassed, the sound was more natural and visceral, albeit a bit boomy on some material. The group thought this was most likely due to the midrange and mid bass EQ that had been applied. In Venue E, only small differences were noticed in midrange and bass with the EQ bypassed.

As noted above, the LFE responses were quite different across the venues, and EQ did little to change that. Listening tests showed that in some cases, applying cut EQ to smooth out a peak was perceived as tightening up the sound, but boost EQ did little to improve the perceived sound.

Though the surround channels were tested with EQ switched in and out, this was ad-hoc and it was determined that there was insufficient data to present in the report. Listening tests were also inconclusive.

d. *Would measurements made in the close-field of the loudspeakers provide information and insight into the sound system’s behavior in addition to using far-field measurements?*

This is well discussed in the preceding sections. A brief summary of the issues to be explored is as follows:

- *Would measuring in the close field and measuring in the far field give significantly different results?*

The high frequency characteristics are very similar; the low frequency is quite different.

- *Would the X-curve still manifest in the close field, or is this only a far field phenomenon?*

The high-end characteristic of the X-curve does manifest in the close field.

- *Would the high frequency response be flatter in the close field measurement and exhibit more roll-off in the far field?*

It is not flatter in the close-field. There is a slightly higher level at the upper frequencies, largely due to the lack of air absorption at the short measurement positions, but the effect is small (1.9 dB at 10 kHz at 15 m with 20°C and 50% RH).

- *Test the effects of different microphones and setup techniques on the measured data.*

Unfortunately, time did not permit doing different setups in a given venue. The group did try microphones at the seat position and at 56" at one Venue and it appeared to help as viewed on the real time analyzers. This data, however, is not captured here. The group did conduct an extensive comparative test with different measurement microphones and that data is presented in Annex D.

- e. *Test the effect of window length on measurements and the effect of variable length windows (PPO)*

Short time windows capture direct sound and early reflections and reject later-arriving reflections. Since our hearing is strongly sensitive to the first arrivals of sound, short window measurements can provide a good insight into the perceived tonality.

These effects are explained in detail in Section 8.5 and example graphs are presented in Sections 12 and Section 15 to 20.

13.13 "Lessons Learned"

A number of lessons have been learned during the testing process with regard to signal path, bandwidth and computation of impulse response:

- a) Beware of sample rate converters in the signal path. Digital routers, network interfaces, and cinema processors often employ them by default, and these must be defeated in order to not compromise the test signal.
- b) Beware of unintended equalization in the signal path. For a dubbing studio, this may be on the mixing board fader; in an exhibition theatre; it may occur after the signal injection point or downstream from the projection booth.
- c) Use a test signal that is natively the same sample rate and bit depth as the analyzer is expecting. As noted in Section 8.3 B, if these do not match, errors may result, as the analyzer is expecting a signal with specific Nyquist characteristics when performing transfer function analysis.
- d) Ensure that the bandwidth of the test signal is at least equal to the bandwidth of the received signal. In this context, the received signal may include background noise at very high and very low frequencies. Some deconvolution algorithms (used to produce the impulse response) are incapable of dealing with a loss of bandwidth in the reference signal, which results in a very high level of noise being added to the impulse response.
- e) Be careful of metering characteristics with relation to pink noise signals. Not all meters give the same result for a given pink noise signal, which can give errors when calibrating SPL. For example, mixing board meters may not agree with dedicated outboard meters.
- f) Meters may measure RMS directly, or measure average and indicate an RMS based on that average, or have varying ballistics. In addition, if the bandwidth of the signal is wider than the bandwidth of the meter, the indication will vary with meter bandwidth.

13.14 General Observations

- a) The results from the different types of analyses show that the general response trends are similar. None of the different presentations, such as 48 PPO or 2-second gated show any significant variations within their valid frequency bands. Even single microphones appear to capture the general trends. It can be inferred from this that the major differences in sounds, from theatre to theatre, probably cannot be attributed in any significant way to the microphone placements or the analysis techniques per se.

- b) As the frequency resolution of measurements increases, the number of microphones that are needed to achieve a meaningful average response also increases.
- c) The present alignment standards and recommended practices leave some room for degradation of the sound system, by using equalization to mitigate problems which should be solved in more fundamental ways.
- d) There is good agreement between the report presented to the SMPTE by the B-Chain Study Group in 2012 and the theatre data analysis presented in this report.
- e) This report demonstrates that the X-curve is being used as the basis for system tuning by both dubbing stages and theatres, but does not address the relevance of this or any equalization curve. However certain measurements (close-field vs. far-field) as well as recent measurement work referenced in this report's bibliography clearly demonstrate that the X-curve is being established primarily by the filtering action of the perforated projection screen, and not by the deep room equalization needed to mitigate a reverberant room response when measured with a time blind (RTA) device.

Expressed another way, a system with a constant output with frequency (a so-called "flat" response) will, when placed behind a typical perforated screen and measured in the room, demonstrate a magnitude response that closely approximates the X-curve response. This was clearly established in the measurements where the X-curve response was seen in the close field response where the timing window of the measurement excluded the late-time room response.

Consequently when a system that is "firing through" a perforated screen is equalized to provide an X-curve response, the response in the room will, in essence, be due to the screen and loudspeaker system.

13.15 The future relies on education

- a) In the real world, the installer does not have time to do the in-depth analysis as done here. That's for acousticians or theatre designers. In most commercial theatres there are two stages in commissioning a new room, commonly performed by different entities. Group (1) would hang and rig the equipment, and group (2) will equalize and calibrate the system. Group (2) is frequently rushed, and doesn't have for example, time to relocate a sub-woofer while trying to determine its optimum phase/polarity.
- b) If indeed, much of the variation between theatres is caused by different equalization techniques, then the need for better education becomes paramount. There needs to be solid discussion about new standards and recommended practices arising from TC 25CSS, and how best to ensure that these are actually implemented on a wide-scale basis.
- c) A future project should include a testing regime in which subjective listening in venues is accompanied by objective tests of system performance. This is a difficult undertaking and will require a statistically significant pool of trained listeners in order make subjective comments, as well as the cooperation of the exhibition industry and equipment manufacturers. This exercise will require a significant investment in time and scheduling, for both local and international participants. The information gained would help enormously in our understanding of the relationship between measured system performance and perceived sound quality in cinemas.

13.16 Moving Forward

- a) This work is a snapshot of the current performance of cinemas and dubbing rooms. It shows both specifics and trends and indicates where improvements might be made. We can say that the performance of the entire B-chain, including the screen and room acoustics, must improve overall if the potential for higher fidelity and more consistent sound is to be realized.
- b) The report presents a great deal of information that can be used to develop a greater understanding of the issues. The report's data can continue to be analyzed so that more information can be gained over time.
- c) By understanding the trends presented here, we have solid information about what is working well and what can be improved. With this knowledge, coupled with the companion standards work that is underway in SMPTE TC-25CSS on recommended calibration methodology and standardized pink noise, the path is clear to create new standards that will provide a higher level of sound system consistency and performance in cinema theatre spaces in the future.



14 RECOMMENDATIONS FOR FURTHER WORK

The study-group's efforts have shown that new standards work will be of benefit to the movie content-creation and presentation communities as well as to SMPTE and liaison organizations, and that SMPTE documents (standards, engineering guidelines, and recommended practices) will be required.

The study group recommends that this standards effort take a fresh look at what needs to be measured, how to measure it, and what action should be taken based on the measurement results. It is recognized that people do not hear as microphones and analyzers measure. This effort with regard to standards will strive to document new measurement and calibration techniques that more closely approximate how people hear, so that a measurement-only calibration procedure can deliver a highly consistent result.

The study group recommends work in three related areas, leading to performance standards that need to be met to ensure consistency and interoperability: 1. Theatre sound-system measurement and calibration; 2. Theatre sound-system system-components' performance; and 3. Theatre acoustics."

Suggested new documents include:

- SMPTE Standard: Electroacoustic Performance of Theatre Sound Systems, In Situ
- SMPTE Recommended Practice: Measurement and Calibration of Theatre Sound Systems
- SMPTE Standard: Theatre Sound-System Performance Requirements and Verification
- SMPTE Engineering Guideline: Designing Theatre Sound Systems to Meet Performance Standards
- SMPTE Standard: Theatre Room-Acoustics and Measurements
- SMPTE Recommended Practice: Measurement and Verification of Theatre Room-Acoustics
- SMPTE Engineering Guideline: Theatre Room-Acoustics Design Considerations



15 RESPONSES OF CINEMA A

15.1 Centre Channel

15.1.1 Audience positions

Figure A 1 shows the response at the reference position and the range of responses over all the listening positions with the three time windows. Figure A 2 shows the average response and the range of responses with the three time windows

15.1.1.1 Discussion of Results

The following points are noted from Figure A 1 for the reference microphone.

- The response at the reference position from approximately 1000 Hz up follows the X-curve, as do the range of responses over all positions.
- The responses of all three windows are very similar above 250 Hz, with only small variations being evident.
- The 50 ms response shows a large dip in the response in the 100 Hz region compared to the 48 PPO and 2 sec responses. Although there is some loss of detail in the 50 ms response below 250 Hz due to the length of the time window, this large dip suggests that the strength of the direct field is either low or there is a strong early reflection is providing a substantial phase cancellation of the direct-field response in this frequency region. It is noted that as 50 ms contains only 5 cycles of a 100 Hz sine wave, the IR of the loudspeakers' direct field at 100 Hz would need to decay within 5 cycles, if it is to be completely contained within this window. Given the bandwidth of these transducers, this is likely to be the case, allowing this time window to provide a useful indication of the early time response.

The average response shown in Figure A 2 is relatively smooth and extended; however three features are noteworthy:

- A narrow but strong peak at approximately 360 Hz is seen all time window responses. As this peak occurs in the average, it is likely to be audible at most locations.
- The dip at 113 Hz seen in the reference response is also present in the average response, and has some manifestation in the longer time window responses. This dip is likely to be audible to some extent.
- In general, the differences in the responses for the different microphone position seem to be within reasonable expectations. However, although the average is relatively flat in the 285 Hz region, there is a large variation between the microphone positions in this frequency range.

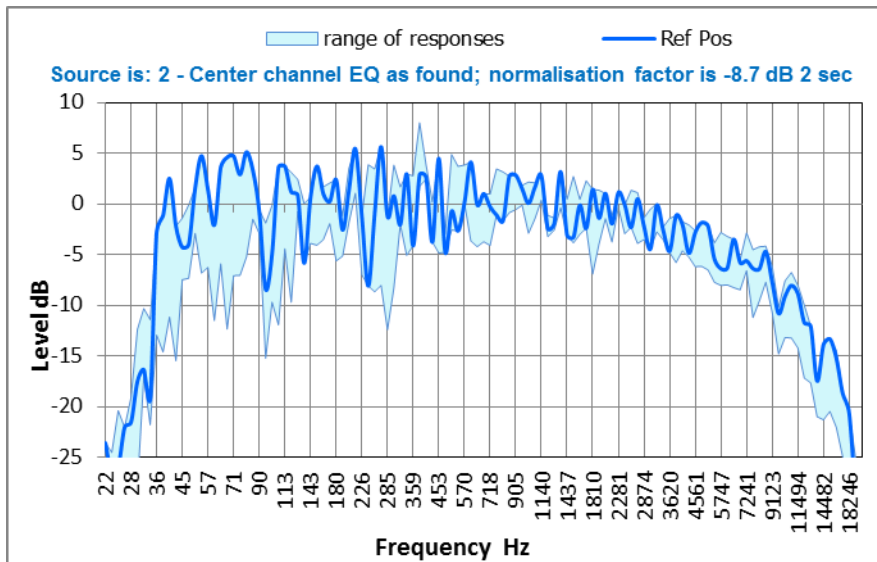
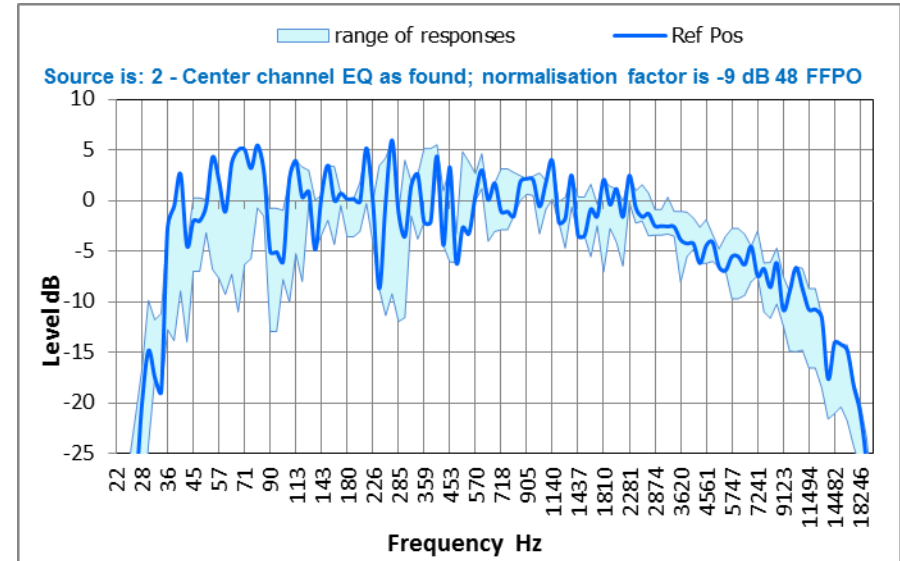
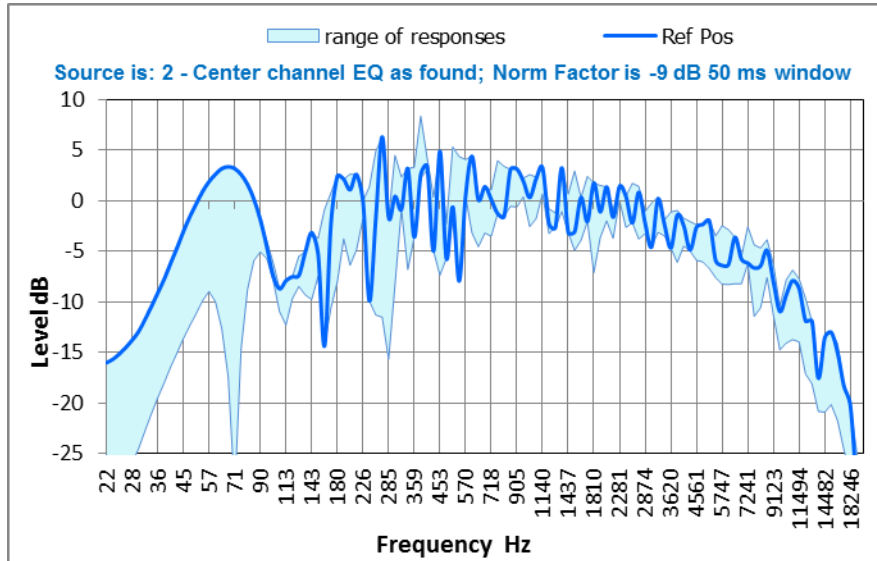

Figure A 1 Cinema A Comparison of microphone positions and time windows for Centre Channel. All responses have been normalized.

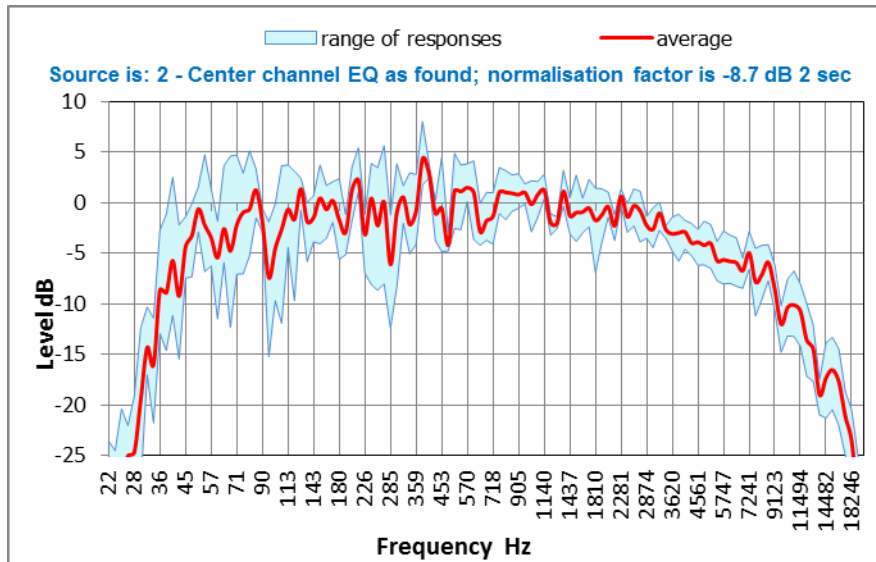
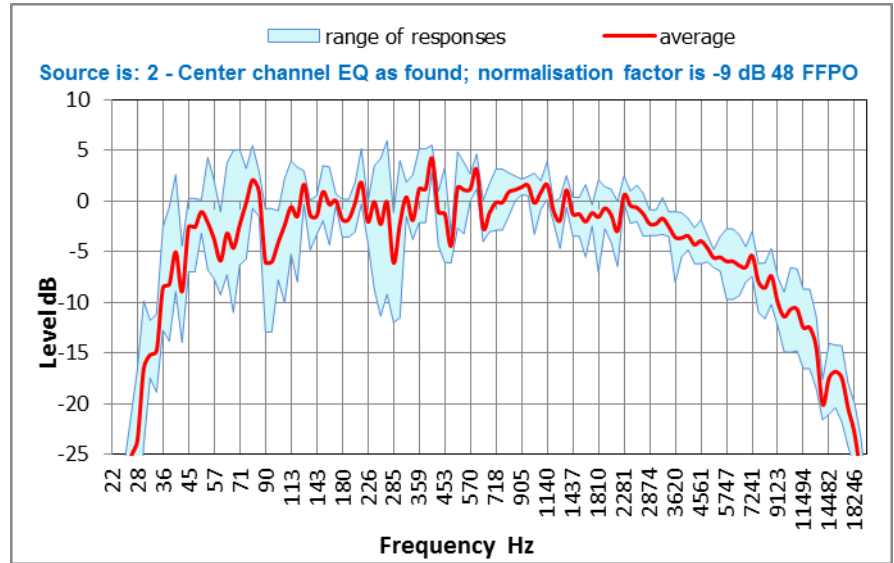
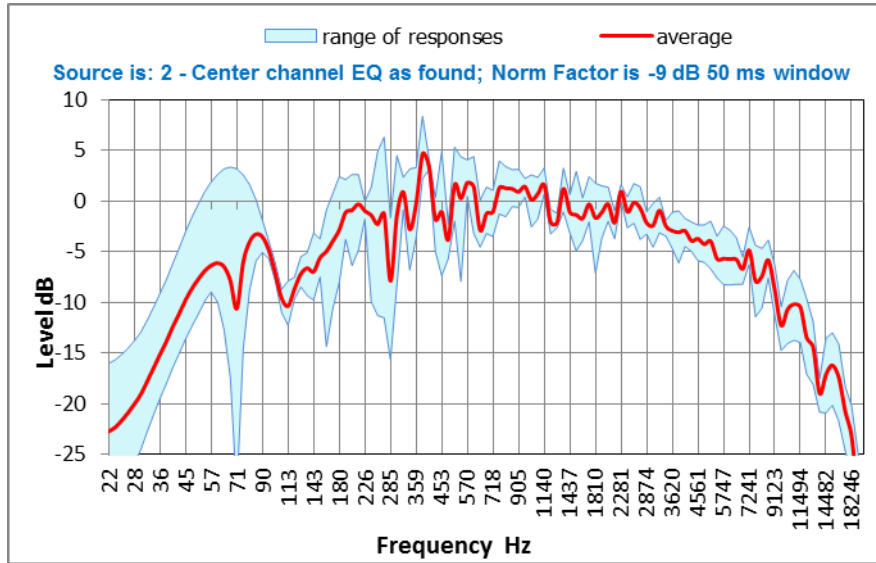

Figure A 2 Cinema A Comparison of the average (pressure), maximum and minimum responses and time windows for given source. Responses are relative to the reference position with a normalized average level over 500 Hz to 2 kHz of 0 dB.

15.2 Comparison of close-field (tree) and listening-area microphone positions for Center Channel

Figure A 3 compares the measured response at the reference position with the response at the tree microphones.

Figure A 4 compares the average listening position response with the response at the tree microphone. The time window used is 48 PPO. Note that Tree A is the highest microphone, Tree B is the middle microphone, and Tree C is the lowest microphone on the tree. Microphone A (highest) was aligned with the high frequency driver as best as possible by eye without having a drawing of the exact loudspeaker configuration.

15.2.1 Discussion of Results

- Except for a peak around 15 kHz, the response of the A and B tree microphones above 1 kHz shows strong similarity with both the reference position and average responses. There is a little more high frequency energy in the tree responses, which is consistent with the air-absorption as the sound travels to the audience area.
- The tree microphones also show an X-curve with a little more high frequency response.
- There is nothing to suggest that the X-curve as measured back in the room is a measurement artifact resulting from a flat response at the screen being attenuated by the room.
- The response of Position C has multiple peaks and dips, even relative to Positions A and B. These may be due to the distance from the individual loudspeaker drivers to the microphone.
- At frequencies below 400 Hz, the tree responses show significant differences with the reference-microphone and average responses. The dip between 300 Hz and 400 Hz for the tree microphone A may be a cancellation caused by different driver distances to the microphone.
- The LF difference below 300 Hz for all tree positions may be partly explained by gain from the room in the audience microphones. The cumulative energy plots of Figure A 20 indicate show a slow increase in the 63 Hz, 125 Hz and 250 Hz bands, which reflect the high RT60 values at these frequencies. The roll-off (shelf) below 80 Hz appears to be associated with the equalization cut at these frequencies shown in Figure A 6 to compensate for room gain.
- Certain characteristics of the measurements can be assessed with confidence if they appear in all three microphone responses. Clearly, there is much commonality between the plots in terms of the HF and LF roll offs, which would not be the case if there were significant geometrical effects due to excessive off-axis positioning. It can therefore be safely concluded that these roll-offs are actually occurring.

15.3 Comparison of Center Channel responses with different time windows at reference position

Figure A 5 compares the responses at the reference position of four time windows by referencing the response of each window to the 2 second response.

Sections of the following responses are not shown due to the lack of resolution resulting from the time/frequency trade-off:

- 10 ms window below 150 Hz
- 50 ms window below 50 Hz

15.3.1 Discussion of Results

- Figure A 5 shows that from approximately 800 Hz up, the responses of the 10 ms, 50 ms and 2 second windows are remarkably similar. This indicates that the direct field strongly dominates the measurements, and that reverberant build-up contributes only a small amount of sound to the total energy at these frequencies.
- The change in frequency response that is noted in (12) due to the arrival of the reverberant field clearly does not occur here.
- The small differences between the 48 PPO and 10 ms and 2 s responses result from the shorter time window of the 48 PPO responses at these frequencies.
- As expected due to window length, the 10 ms window starts to differ from the 2 s reference at around 700 Hz while for the 50 ms window, this point moves to 200 Hz. The 48 FFPO window response shows some difference from 20 Hz to about 700 Hz and then from about 2.5 kHz to about 10 kHz.

15.4 Effect of equalization on Center Channel and X curve

Figure A 6 shows the effect of equalization on the Center channel response at the reference position, along with the published X curve. To show the relative levels, the responses were not normalized.

15.4.1 Discussion of Results

- Both the equalized and unequalized responses of the center channel follow the high frequency X curve closely up to 6 kHz.
- Between 6 kHz and 13 kHz, the equalized response is closer to the X curve than the unequalized response. Additional boost equalization at the high-end may be warranted if the capacity to do so is available.
- The unequalized LF boost in the room, below 100 Hz may be due to room gain by reflections and reverberation or an incorrect level adjustment on the low frequency speaker. The roll-off measured at the tree microphones in this region is therefore partly a consequence of the applied equalization to control the LF build-up in the room.

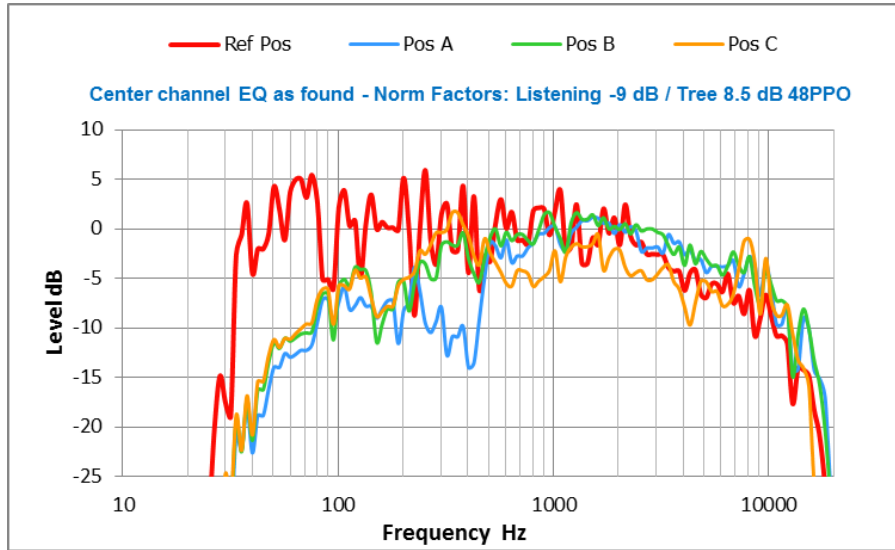

Figure A 3 Cinema A Responses at tree mics with response at reference microphone for Center Ch and 48 PPO window. Responses are normalized to Pos B.

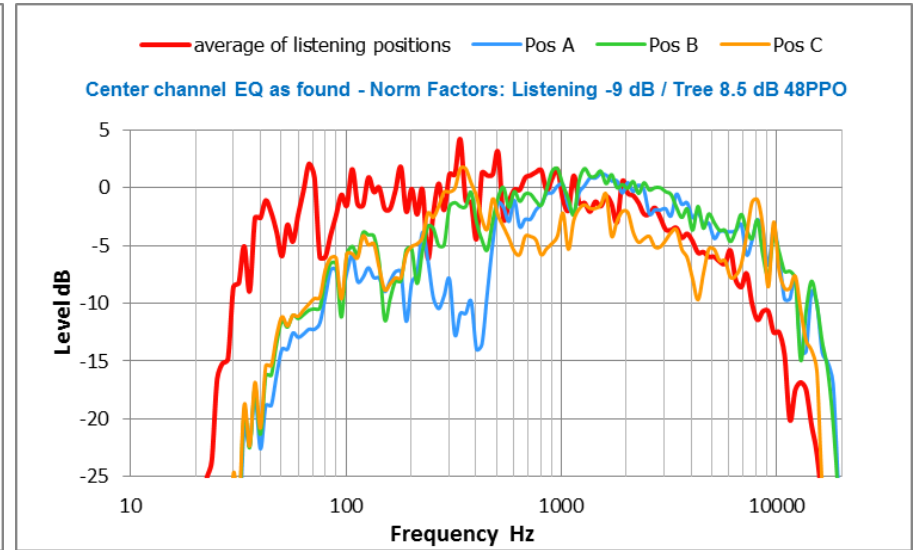

Figure A 4 Cinema A Comparison of average listening response with tree position mics for Center Ch and 48 PPO window. Tree responses are normalized to Pos B.

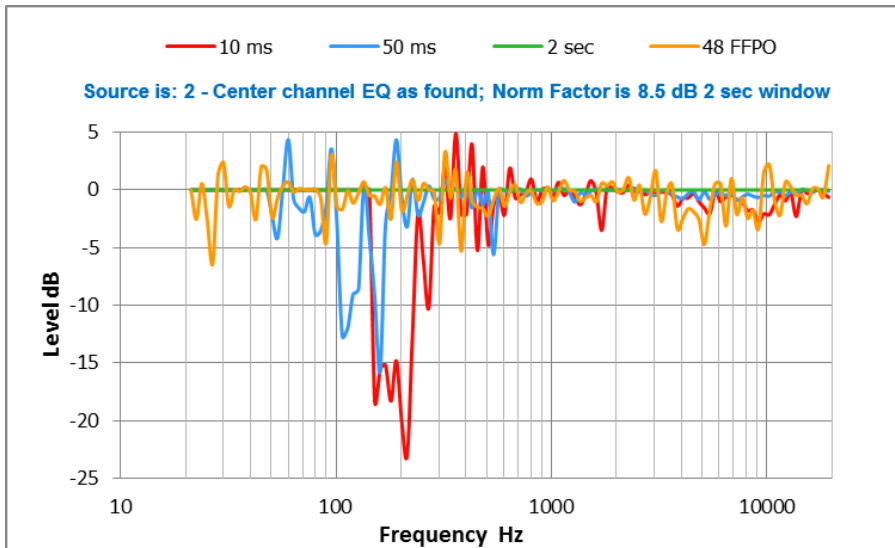

Figure A 5 Cinema A Responses with different windows at ref position Center Channel. NB 10 ms and 50 ms responses are truncated according to the time/frequency limit.

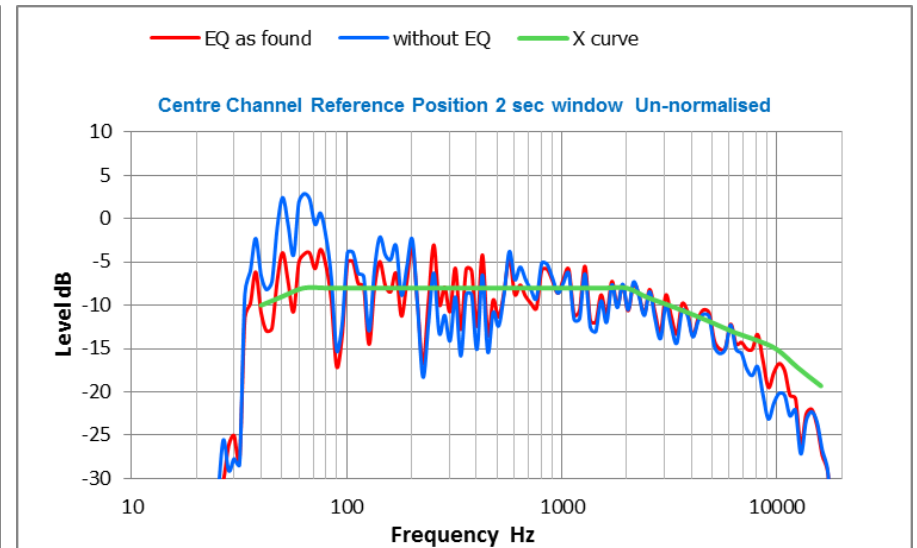

Figure A 6 Cinema A Comparison of responses of Centre Channel with and without equalization with X curve at reference position. Data is not normalized.



15.5 Comparison of front channels and time windows at Reference position

The responses of the left, center and right channels are shown for the three time windows.

- Figure A 7 A/B/C compare the responses at the reference position of the left, center and right channels.
- Figure A 7 D shows the overall range of responses of the three channels.
- Figure A 8 A/B/C compares the average response of the three channels.

15.5.1 Discussion of Results

- Figure A 7 indicates that at the reference position, the left loudspeaker has a pronounced HF loss above 5 kHz compared to the center and right channels. Otherwise, the left and right responses are commendably symmetrical.
- As the center channel has a different acoustic load at low frequencies to the left and right channels, its different pattern of peaks and dips at LF is to be expected.
- The average responses of Figure A 8 show a high degree of uniformity between the three screen channels.

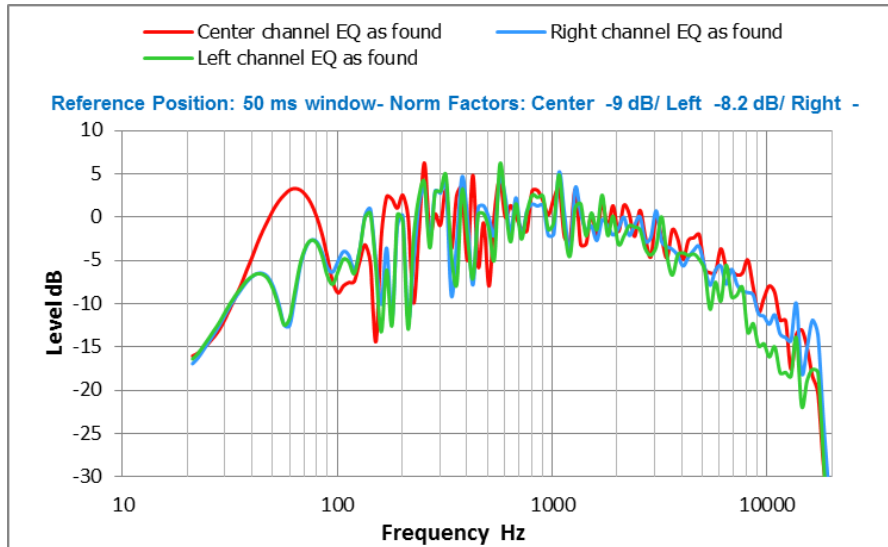

A 50 ms window.

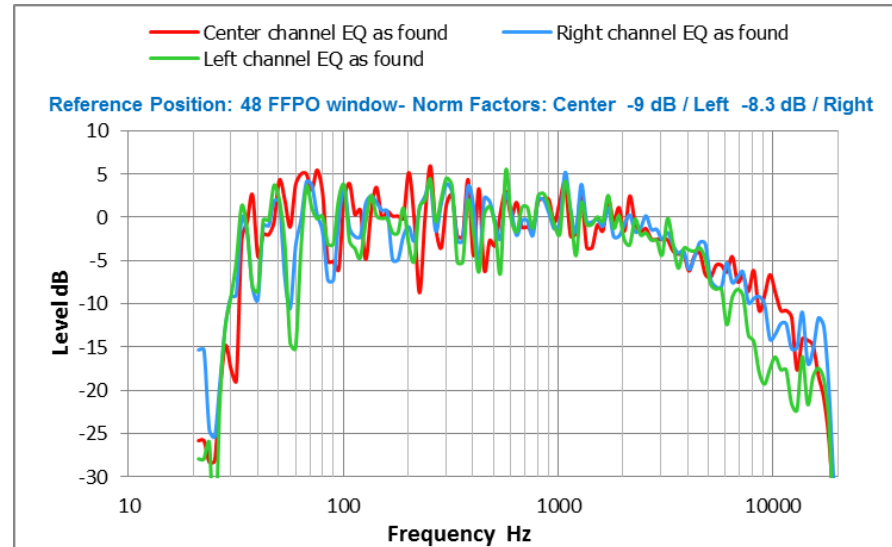

B 48 PPO window

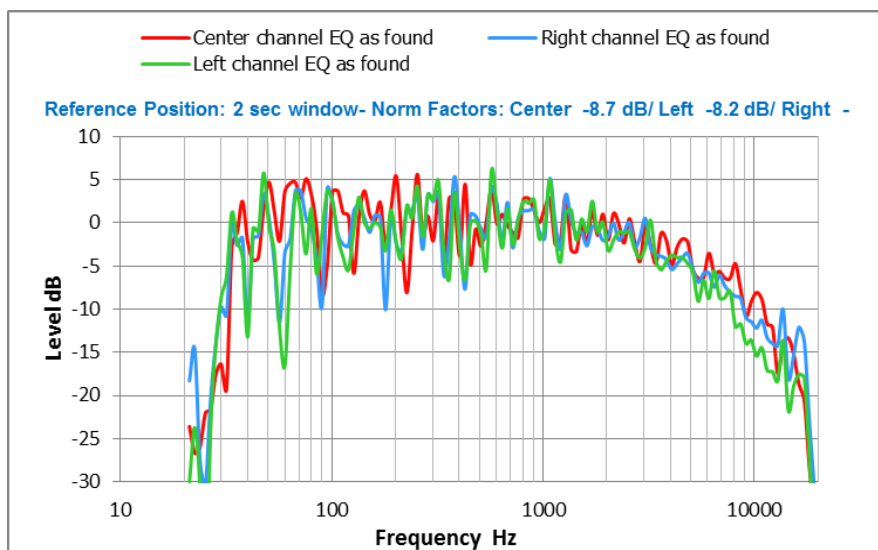

C 2 second window.

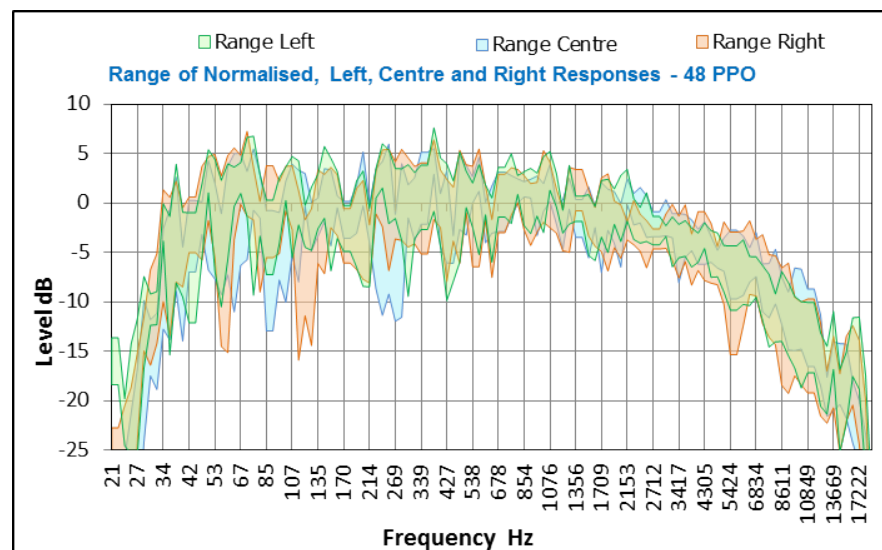

D 48 PPO window

Figure A 7 A, B and C: Cinema A Comparison of L,C,R responses with equalization at reference position with time windows as noted. Responses are normalized. D: Comparison of maximum and minimum extremes over listening positions.. Responses are normalized.

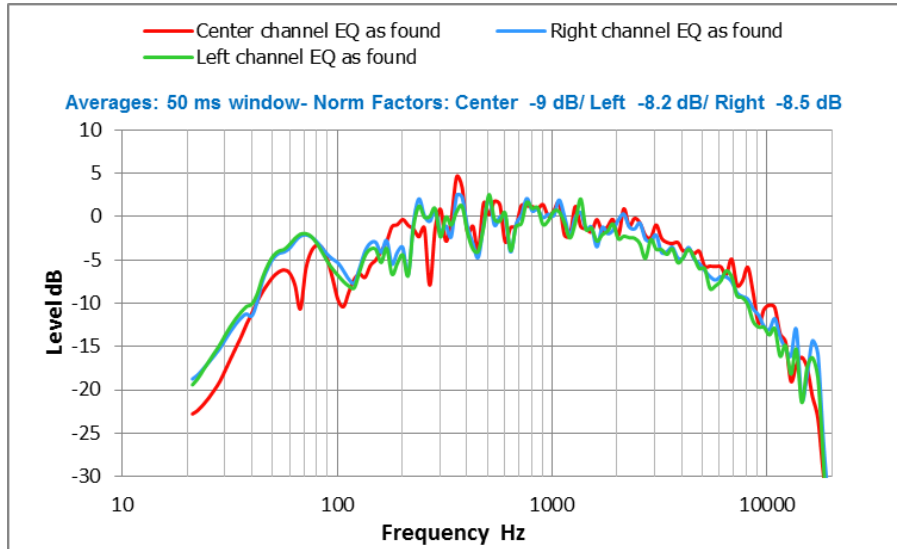

A 50 ms window. .

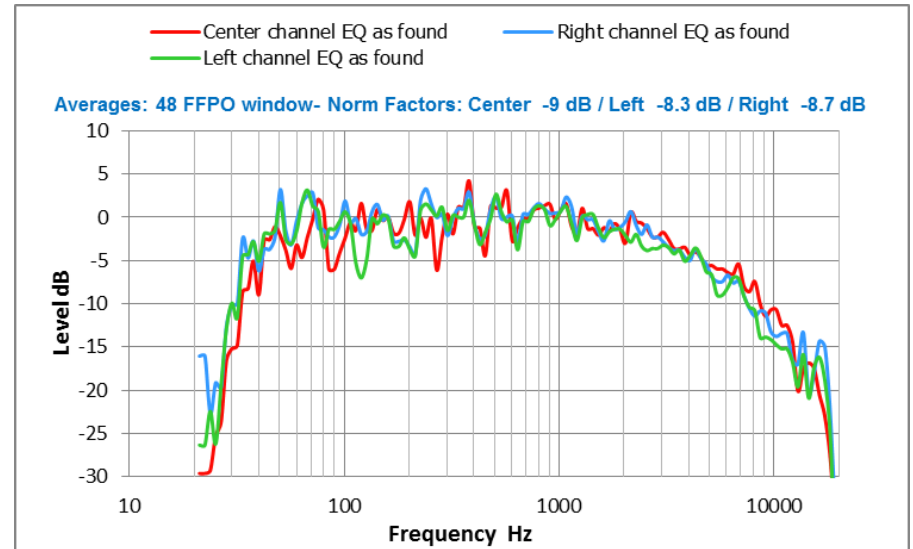

B 48 PPO window .

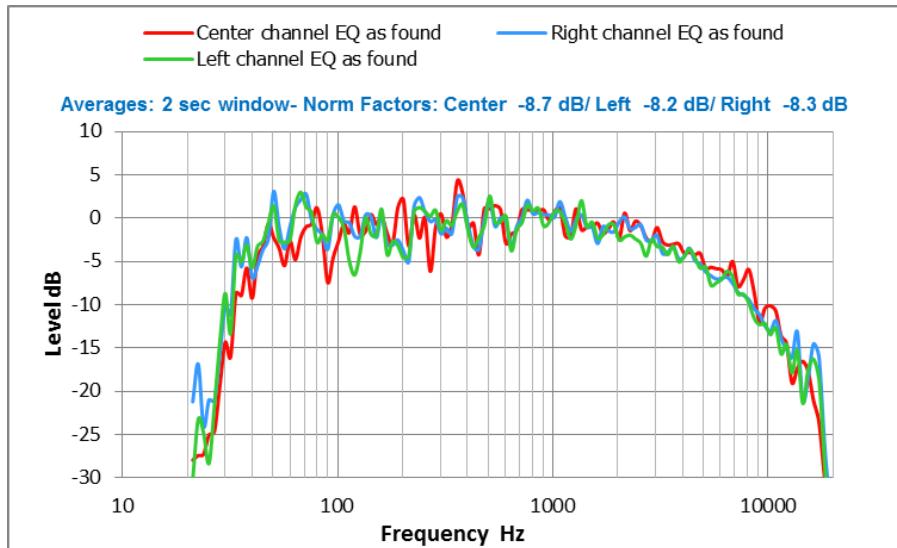

C 2 second window.

Figure A 8 A, B and C: Cinema A Comparison of average L,C,R responses with equalization with time windows as noted. Responses are normalized prior to averaging.

15.6 LFE Channel

The following figures show responses for the LFE channel based on a 2 s window:

- Figure A 9 compares the response at the reference position with the range of responses over the microphone positions.
- Figure A 10 shows the average response over the listening area and the range of responses over the microphone positions.
- Figure A 11 compares the responses at the five microphone positions.
- Figure A 12 compares the average response over the listening area with and without the as-found equalization. To allow assessment of the effect of equalization on the overall level of the LFE channel, normalization was not applied to these responses.
- In the above figures, the responses have been normalized to the average level of the Reference position over the range 40 Hz to 100 Hz.

15.6.1 Discussion of Results

- Figure A 9 and Figure A 10 show that the response at the reference position is substantially higher than the average in this room. The overall deviation in both figures is by no means excessive.
- The average response is not as flat as desired, showing depressions in the regions of 60 Hz and 120 Hz.
- The LFE loudspeaker appears to begin rolling off at 40 Hz, which is quite high. About 3 dB of boost seems to have been applied below this frequency, to help to extend the response.
- As the reference response in Figure 9 exaggerates the trends of the average response in Figure 10, the use of a single microphone measurement technique for the LFE channel might be possible, but extreme care would be required if equalization was to be undertaken.
- The equalized response shows that the 40 Hz to 90 Hz region has been attenuated, which some similarity with the sub-100 Hz roll-off has seen on the screen channels via the tree microphones. This suggests that the room has considerable reverberant build-up in the 45 Hz to 90 Hz octave.

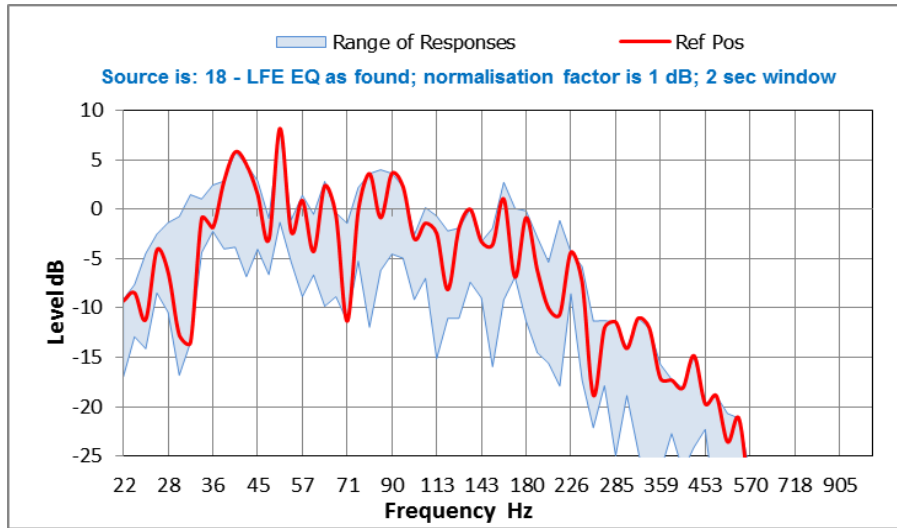

Figure A 9 Cinema A . Comparison of responses in listening area of LFE channel.

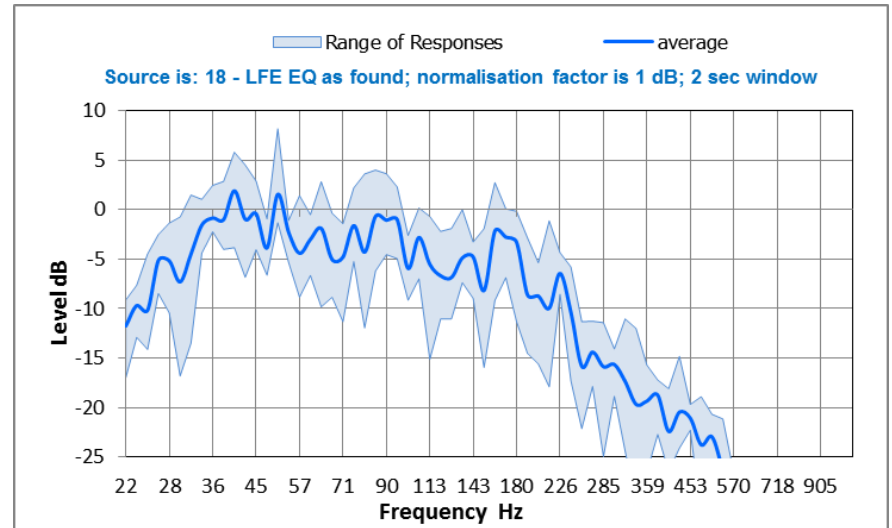

Figure A 10 Cinema A Comparison of average LFE response with extremes

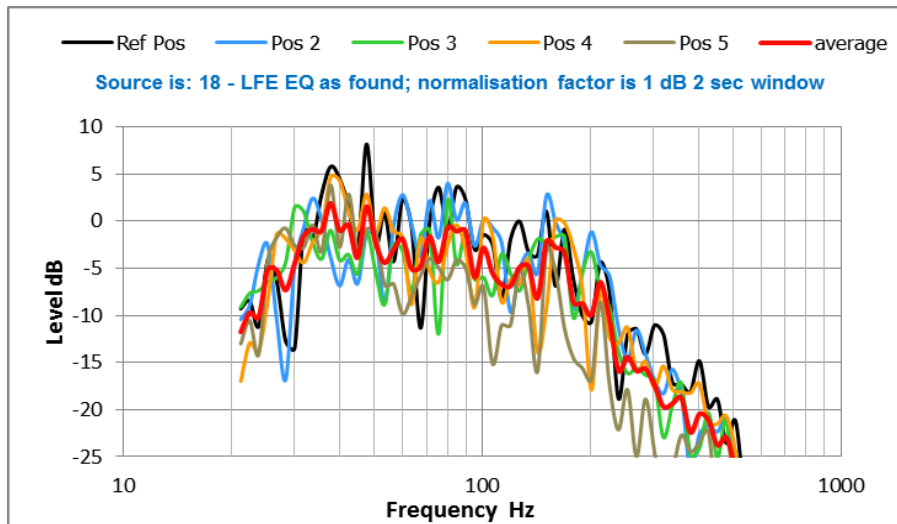

Figure A 11 Cinema A Comparison of responses of LFE channel at the five microphone positions..

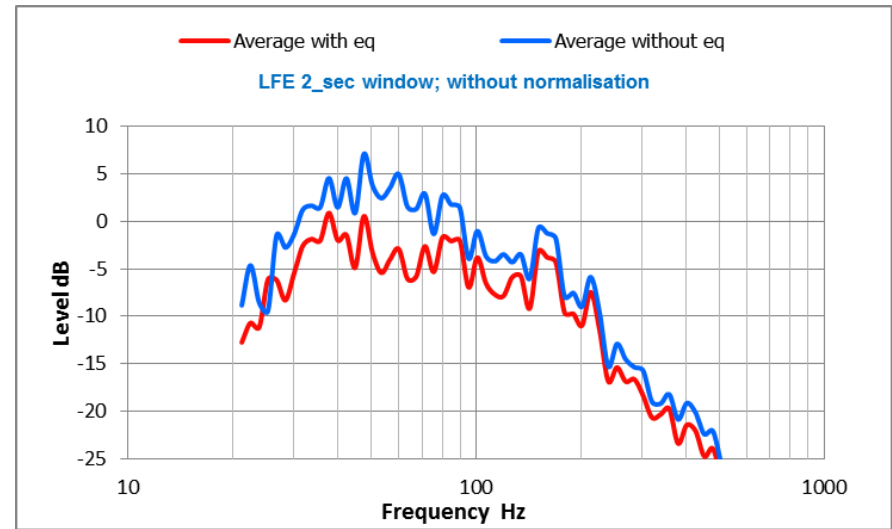

Figure A 12 Cinema A Comparison of average responses of LFE channel with and without equalization.



15.7 Surround channels

Figure A 14 compares the 48 PPO responses of the left surround channel at the five microphone positions with the average response. Figure A 15 compares the 48 PPO response at the reference position with the range of responses.

All responses were normalized to the average level of the Reference position.

15.7.1 Discussion

- Figure A 14 shows that the left-surround channel clearly exhibits a 'standard', large-room, main channel, X-curve response that is in accordance with ST202. Members of 25CSS seem to be divided about whether this is desirable or not."
- The response also extends down to 40 Hz, which is not typical of the surrounds in all of the theatres tested, but it does correspond quite well with ST202.

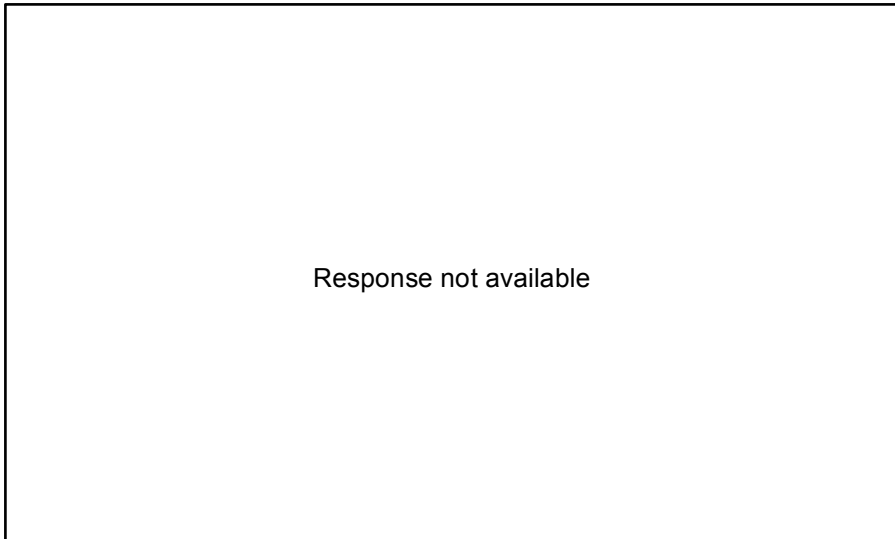

Figure A 13 Response not available.

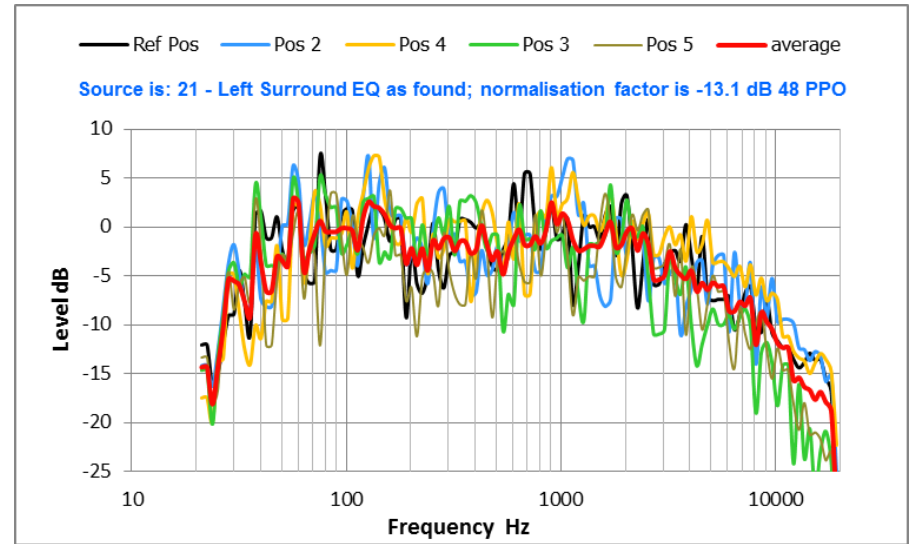

Figure A 14 Cinema A Response of Left Surround over measurement positions with average of with 48 PPO window. Responses normalized to ave. level of Ref pos

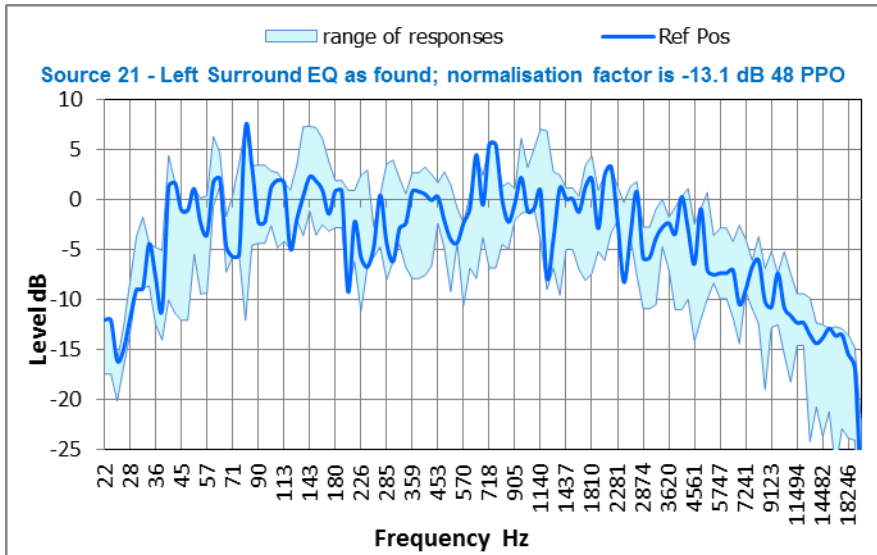

Figure A 15 Cinema A . Responses in listening area for Left Surround channel with window. Responses normalized to average level of Ref position.

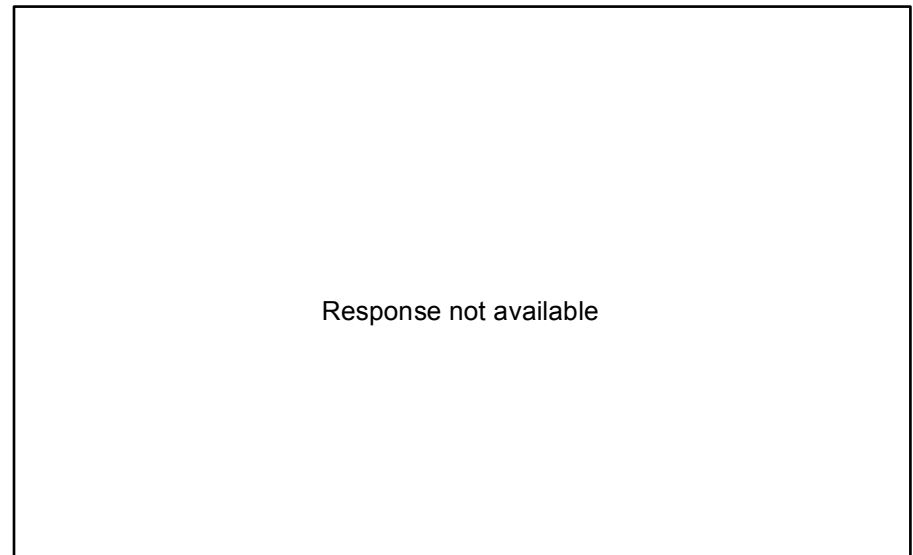

Figure A 16 Response not available

15.8 Room Acoustic Measures

Temporal parameters that have been derived from the impulse response of the Centre Channel at the Reference position are shown in the following figures.

- Figure A 17 shows the logarithmic impulse response filtered to the range of 500 Hz to 4 kHz and calculated as $20 \cdot \log(\text{voltage})$
- Figure A 18 shows the Schroeder decay curve associated with the impulse response
- Figure A 19 shows the reverberation times computed from the Schroeder decay range of -20 dB to -40 dB.
- Figure A 20 shows the cumulative energy in octave bands.

15.8.1 Discussion

- The direct sound arrives around 50 ms after the signal is presented to the loudspeaker and there appear to be strong reflections around 75 ms and 210 ms after the direct sound arrives. The effect of these reflections is seen as the bumps in the Schroeder decay curve and discontinuities in the cumulative energy plots. The level and arrival time of the 75 ms is likely to render it quite audible with transient sounds such as speech.
- The reverberant decay is smooth and uniform.
- The reverberation times (RTs) shown in Figure A 19 for the 63 Hz and 125 Hz bands of 2 s and 1.6 s respectively are substantially higher than that generally accepted for a cinema of this size. These reverberation times are likely to result in poorly defined bass sound and some chestiness in male voices.
- The RTs at 500 Hz and up are reasonably similar.
- The cumulative energy graph shows that the development of the sound field in the 63 Hz octave is significantly more rapid than in the 125 Hz. Given that the reverberation time is higher at 63 Hz than at 125 Hz, this is unusual, and indicates that the arrival of a reflection (or series of reflections) removes energy in the 125 Hz bands in the period of 50 to 150 ms,

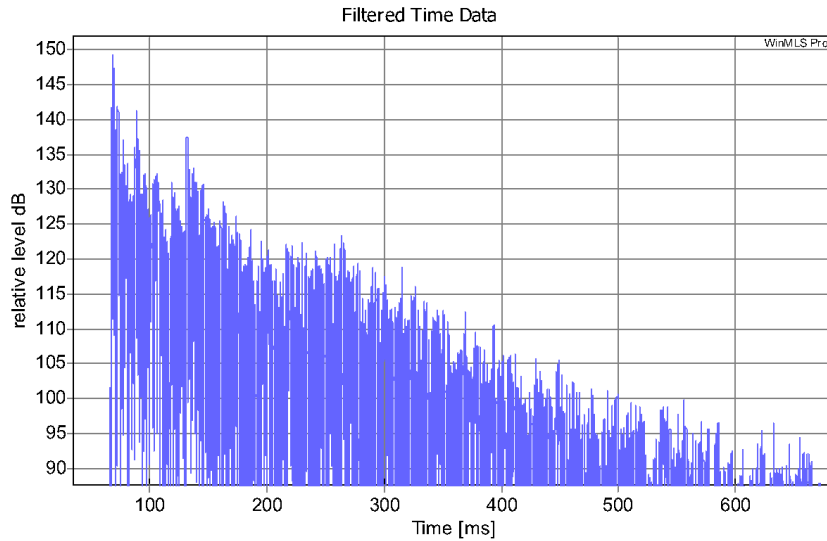

Figure A 17 Cinema A Impulse Response filtered 500 Hz to 4 kHz (20 log abs(v))

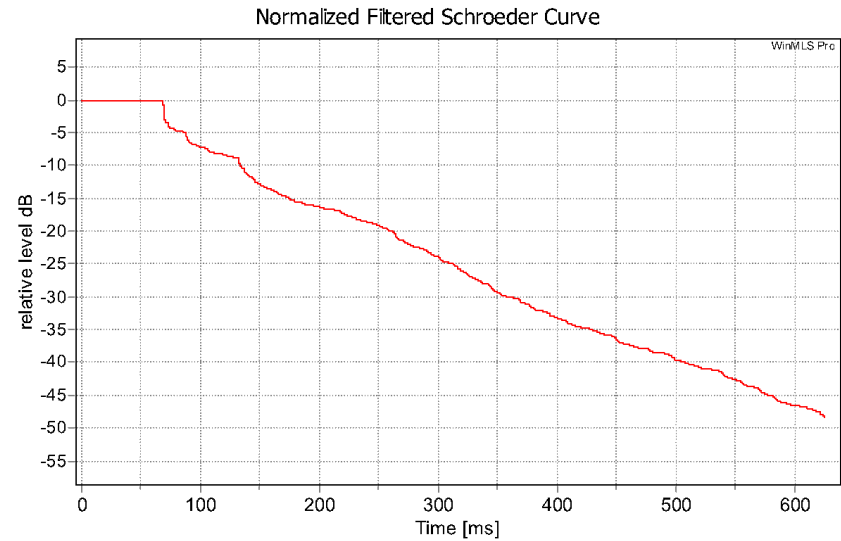

Figure A 18 Cinema A Schroeder decay plot filtered 500 Hz to 4 kHz

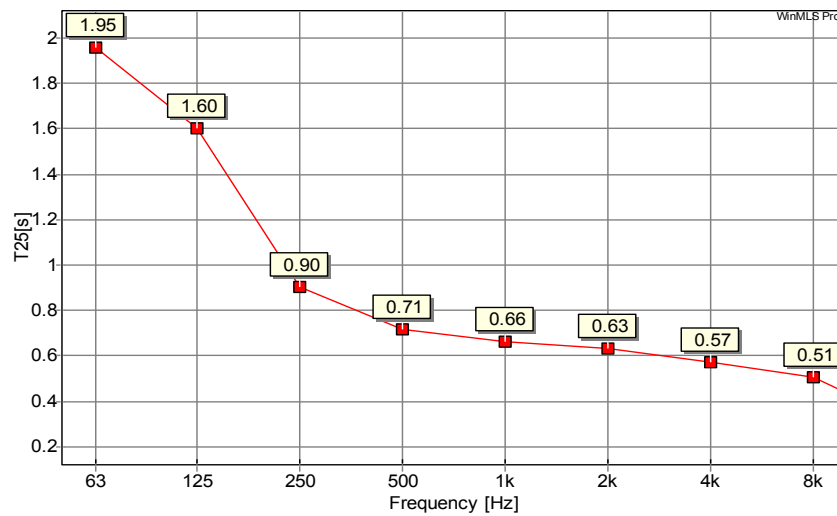

Figure A 19 Cinema A . Reverberation times over decay range -20 dB to -40 dB

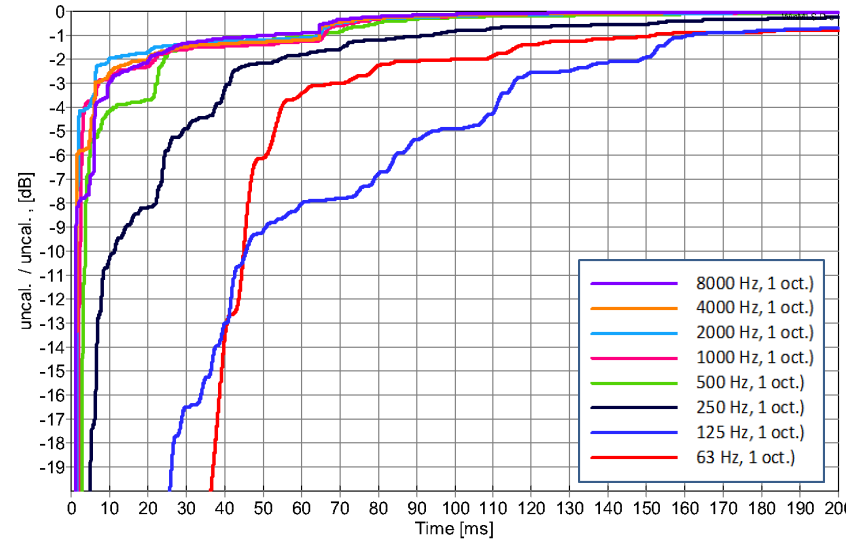

Figure A 20 Cinema A Cumulative energy in octave bands.

16 RESPONSES OF CINEMA B

Cinema B was considered by the study group to be the reference “benchmark” theatre, and was the first theatre to be measured. All measurements were made “as found”-no measurements were made with the system EQ bypassed.

16.1 Centre Channel

16.1.1 Audience positions

Figure B 1 shows the response at the reference position and the range of responses over all the listening positions with the three time windows. Figure B 2 shows the average response and the range of responses with the three time windows. Figure B 3 compares the average response with the individual position responses.

16.1.1.1 Discussion of Results

- Figure B1 shows more energy below 120 Hz in the 50 ms plot than does the corresponding plot for Venue A, indicating more sound has arrived in this period. This is also seen in the cumulative energy plots.
- The low-frequency response rapidly falls at 40 Hz, which is considerably higher than Venue A's roll off of 32 Hz.
- All three measurements time window responses are remarkably similar above 120 Hz.
- The response at the reference position shows the essential trends of the other responses of the positions and the average response.
- The average response shows a sharp shelf around 2.5 kHz, and the high frequency roll off is not particularly smooth.
- In general, the differences in the responses for the different microphone positions seem to be within reasonable expectations.
- There is considerable similarity between the positions, however above 2.5 kHz, there are important differences in the smoothness of their high frequency responses.

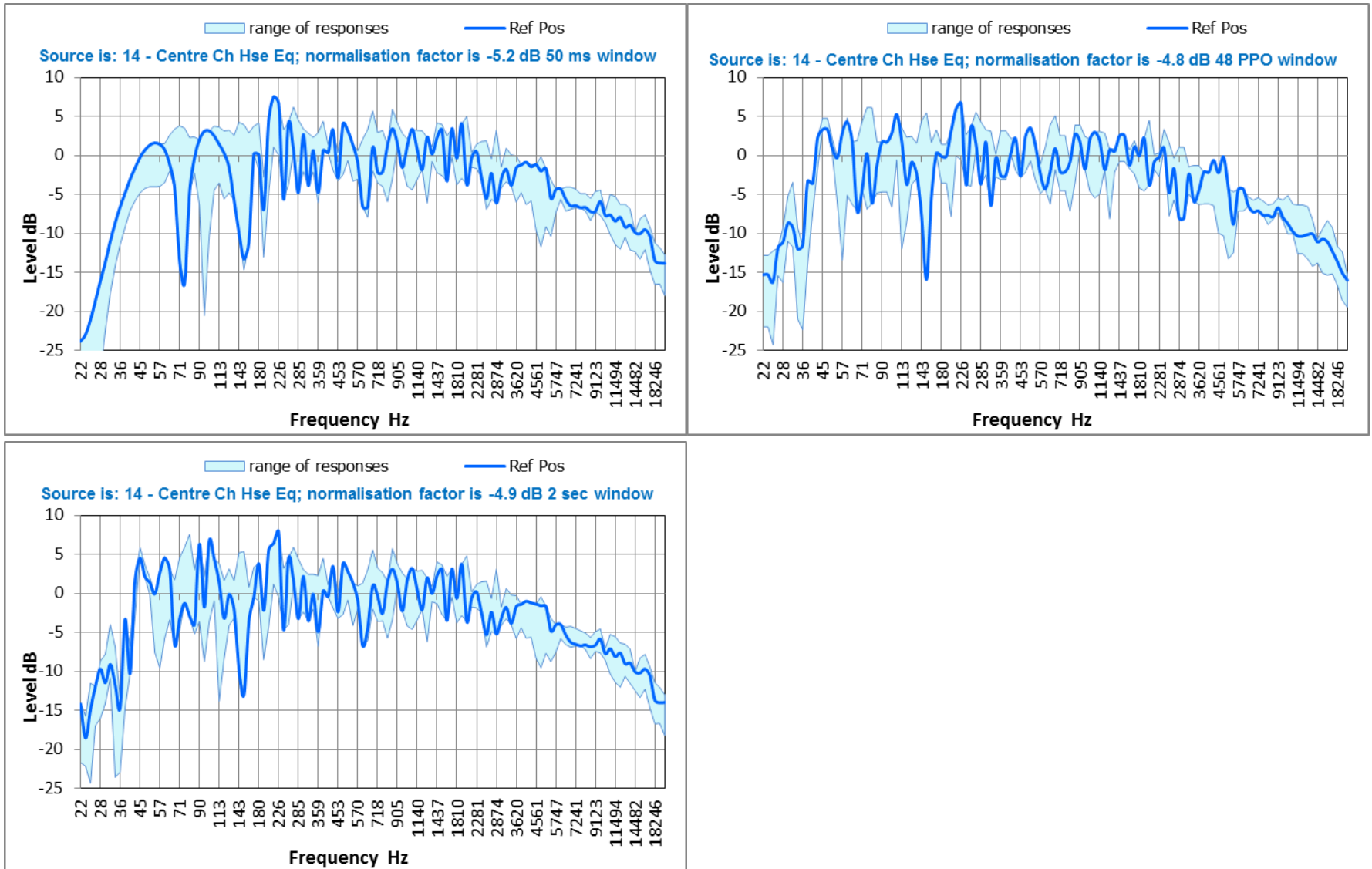

Figure B 1 Cinema B Comparison of mic positions and time windows for given source. Responses have been normalized'.

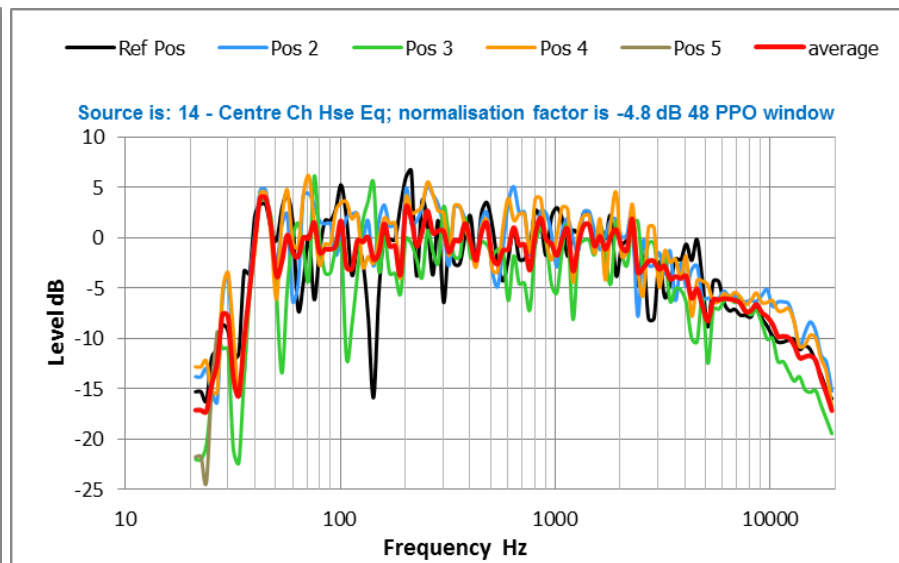
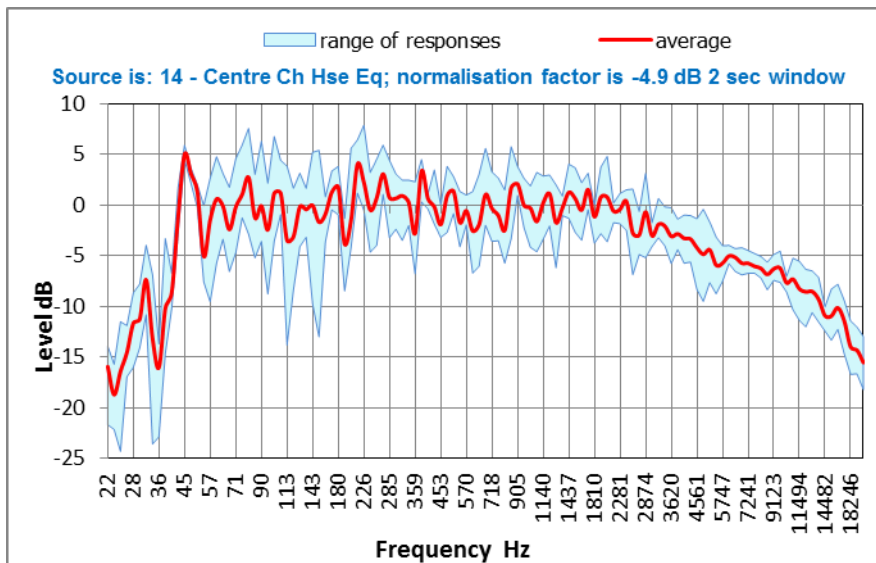
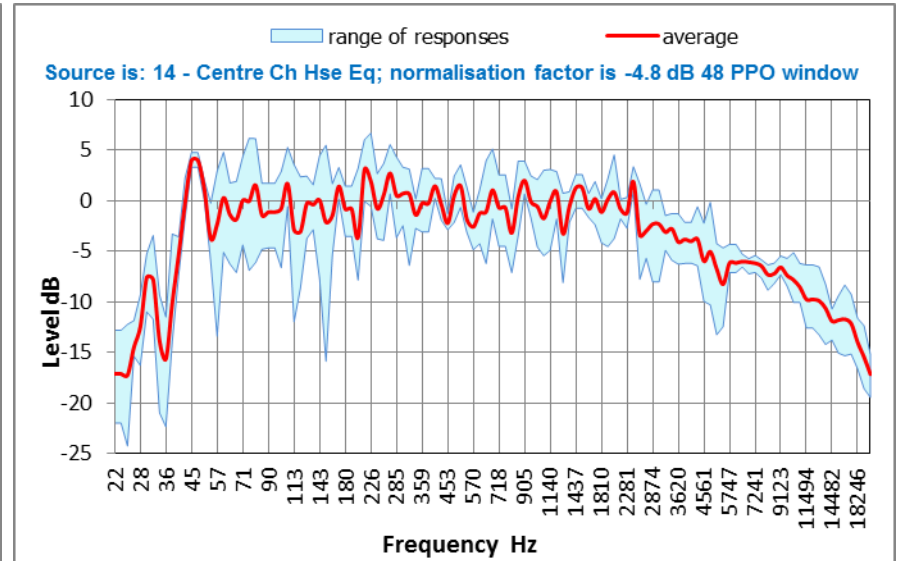
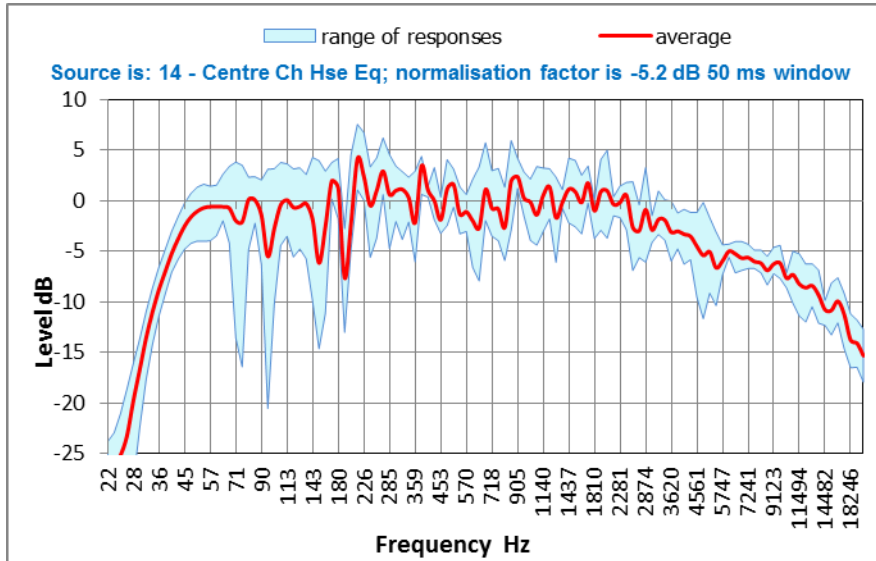

Figure B 2 Cinema B Comparison of the average (pressure), maximum and minimum responses and time windows for given source. Responses have been normalized.

Figure B 3 Cinema B Comparison of the average (pressure) and positional responses and time windows for 48 PPO. Responses have been normalized.



16.2 Close-field responses

The close-field responses of the reference cinema referred to in Section 7.3.8, were processed using the Systune Pro RTA. Based on the similarity of the transfer function and RTA methods noted in Section 8.6 and the absence of a need to analyze the temporal response of the system, the RTA approach was deemed suitable.

The power responses of the microphone signals were averaged in Excel, along with the power average of the input signals. The ratio of the output and input signals was formed to provide the spatially-averaged close-field response of the center-channel system.

Figure B 4 shows the spatial average of the close field positions along with the responses at the reference position and the average listening area response. The level of the close-field average has been arbitrarily adjusted to show some alignment with the reference and average of the far-field responses.

16.2.1 Discussion of Results

- Above 800 Hz, the shape of the close-field response is similar to that of the audience responses.
- Compared to the audience responses, the close field response shows less roll-off as the frequency increases. This is consistent with air-absorption losses that increase with frequency and distance and therefore affect the audience microphones far more than the close field.
- Below 800 Hz, the similarity of the close-field response shape shows differences with the reference and average responses of the far-field. To explain these differences, it would be necessary to understand the specific details of the measurement locations relative to each loudspeaker driver in the Center channel.

16.3 Comparison of Center Channel responses with different time windows at reference position

Figure B 6 compares the responses at the reference position of four time windows by referencing the response of each window to the 2 second response. .

Sections of the following responses are not shown due to the lack of resolution resulting from the time/frequency trade-off:

- 10 ms window below 150 Hz
- 50 ms window below 50 Hz

16.3.1 Discussion of Results

- From approximately 800 Hz up, the responses of the 10 ms, 50 ms and 2 second windows are remarkably similar. This indicates that the direct field strongly dominates the measurements, that reverberant build-up contributes only a small amount of sound to the total energy at these frequencies.
- The change in frequency response that is noted in (12) due to the arrival of the reverberant field clearly does not occur here.
- The small differences between the 48 PPO and 10 ms and 2 s responses result from the shorter time window of the 48 PPO responses at these frequencies.
- As expected due to window length, the 10 ms window starts to differ from the 2 s reference around 700 Hz while for the 50 ms window this point is about 200 Hz.

16.4 Effect of equalization on Center Channel and X curve

Measurements were not made of the effect of equalization on the Center channel response at the reference position.

16.4.1 Discussion of Results

- The response of the center channel shows an excellent fit to the high frequency X curve up to 14 kHz.

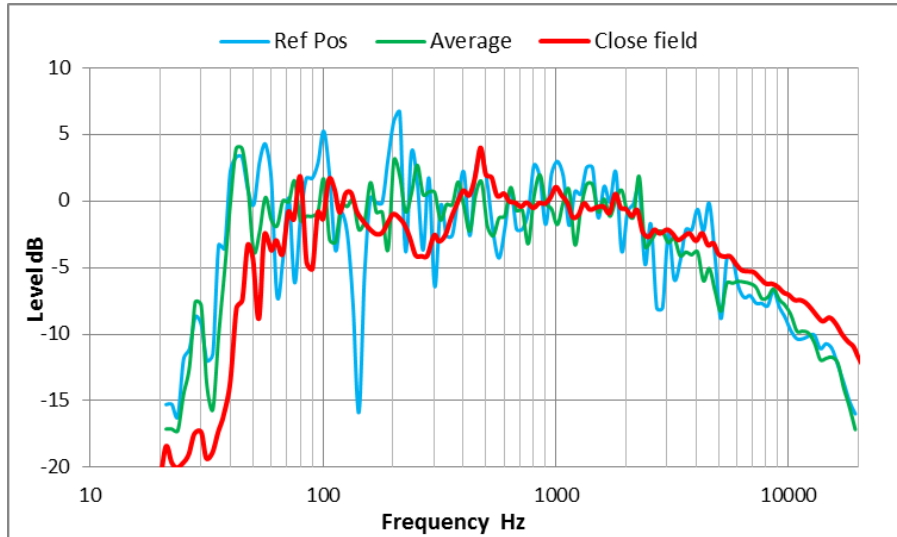

Figure B 4 Cinema B Average of six positions measured in the close field of the center speaker with a 2 second window shown with reference and average 48 PPO responses.

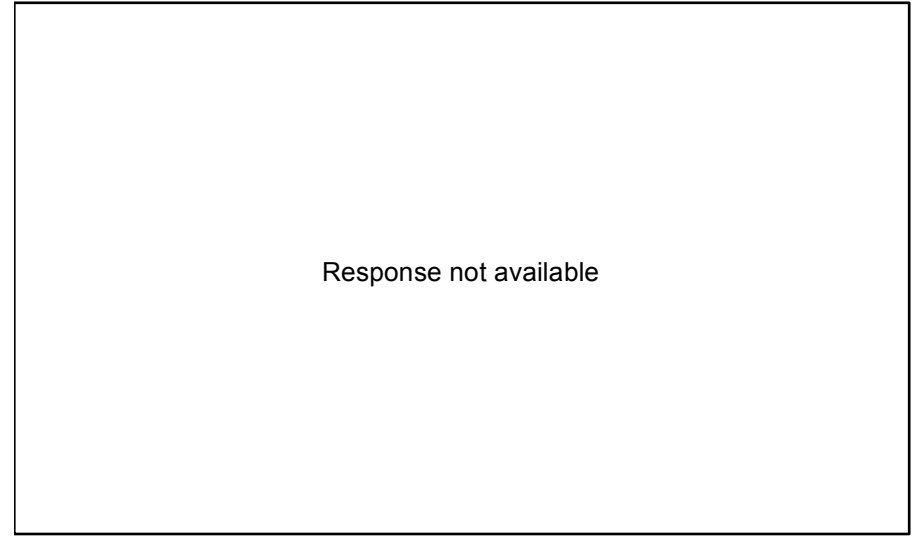

Figure B 5 Response not available

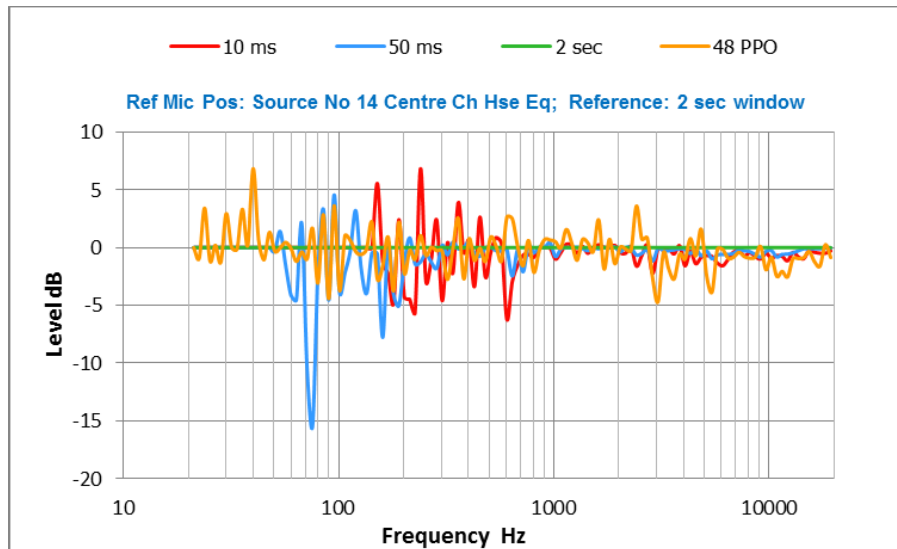

Figure B 6 Cinema B Responses with different windows at ref position Center Channel. NB 10 ms and 50 ms responses are truncated according to the time/frequency limit. normalized.

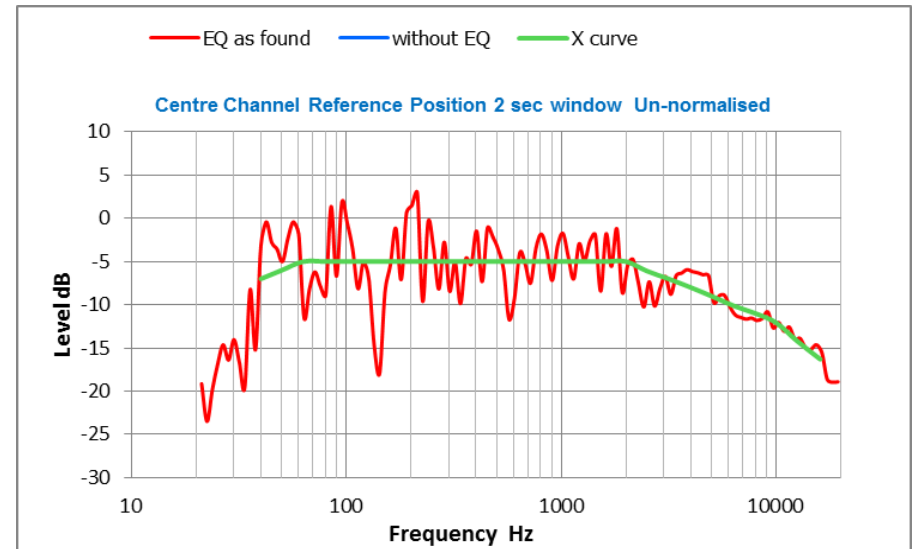

Figure B 7 Cinema B Comparison of responses of Centre Channel with equalization with X curve at reference position. Data is not normalized.



16.5 Comparison of front channels and time windows at Reference position

The responses of the left, center and right channels are shown for the three time windows.

- Figure B 8 A/B/C compare the responses at the reference position of the left, center and right channels.
- Figure B 8 D shows the overall range of responses of the three channels.
- Figure B 9 A/B/C compares the average response of the three channels.

16.5.1 Discussion of Results

- The general similarity of the responses is good. The response of the left and right channels is smoother than the center channel in the 2.5 kHz region.
- The response of the left and right channels around 50 Hz at the reference position is similar, but deviates from the response of the center channel. This is likely to result from reflections from the side walls, which are closer in proximity to the lateral loudspeakers.

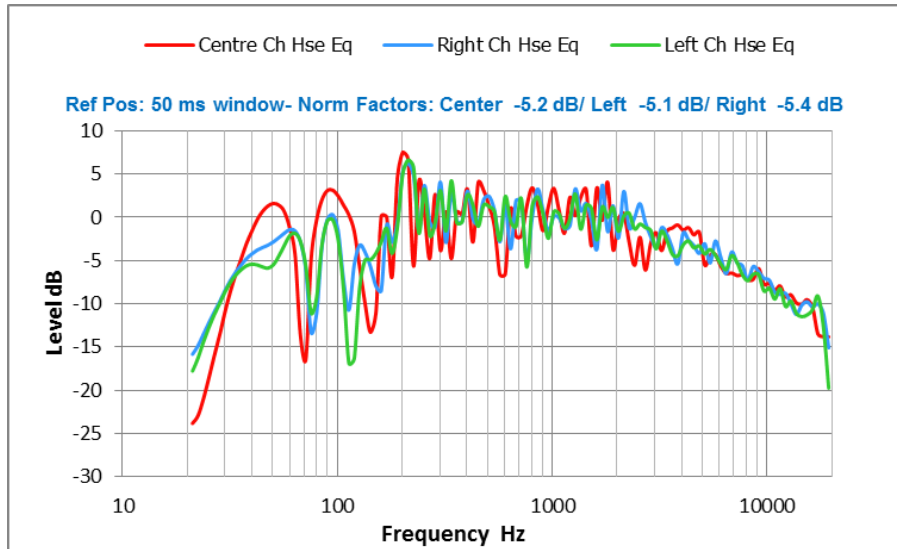

A 50 ms window.

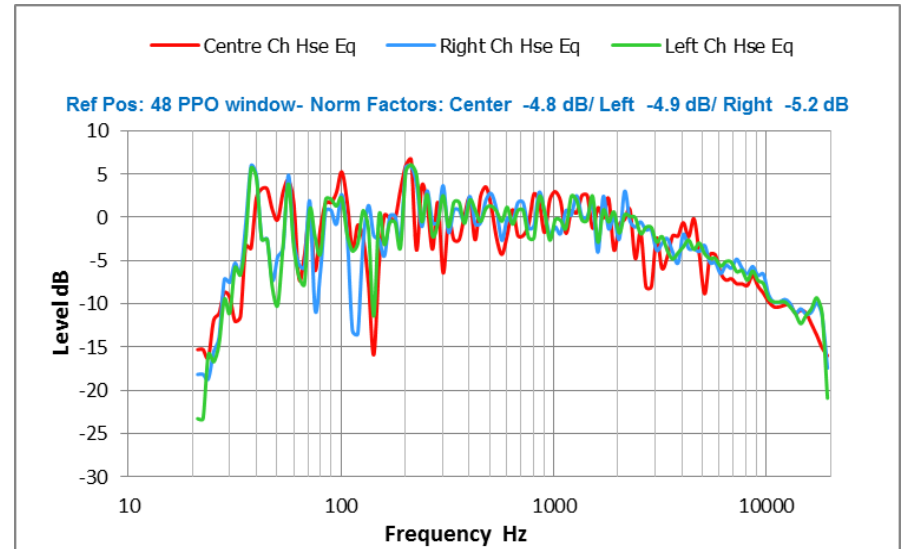

B 48 PPO window.

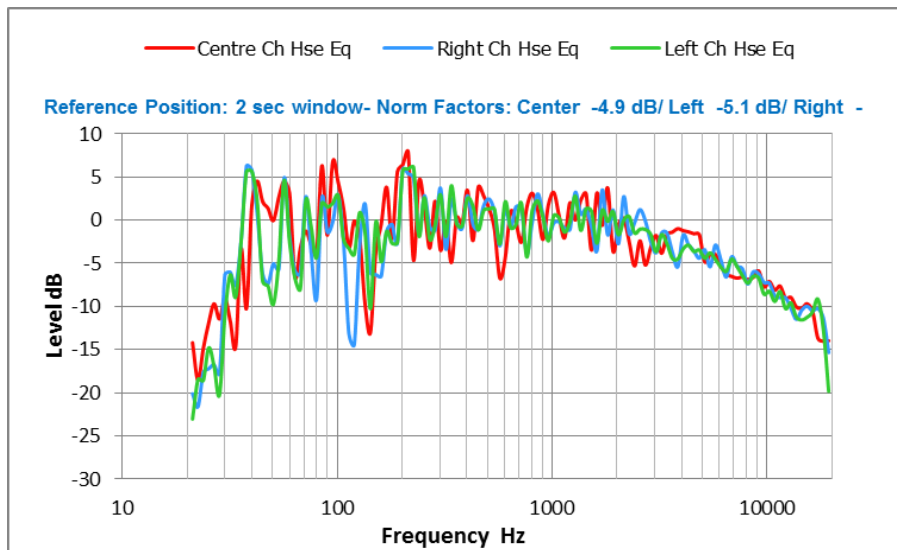

C 2 second window .

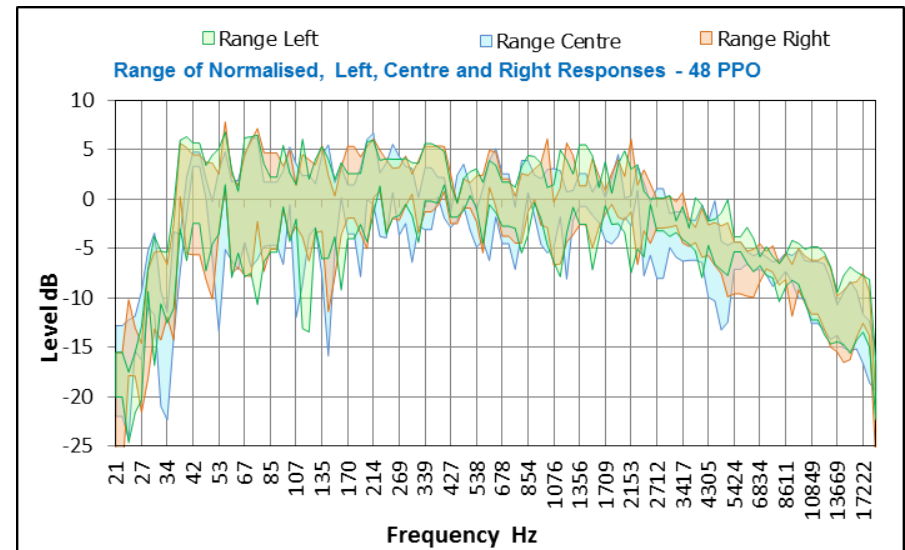

D 48 PPO window.

Figure B 8 A, B and C: Cinema B Comparison of L,C,R responses with equalization at reference position with time windows as noted. Responses are normalized. D: Comparison of maximum and minimum extremes over listening positions.. Responses are normalized.

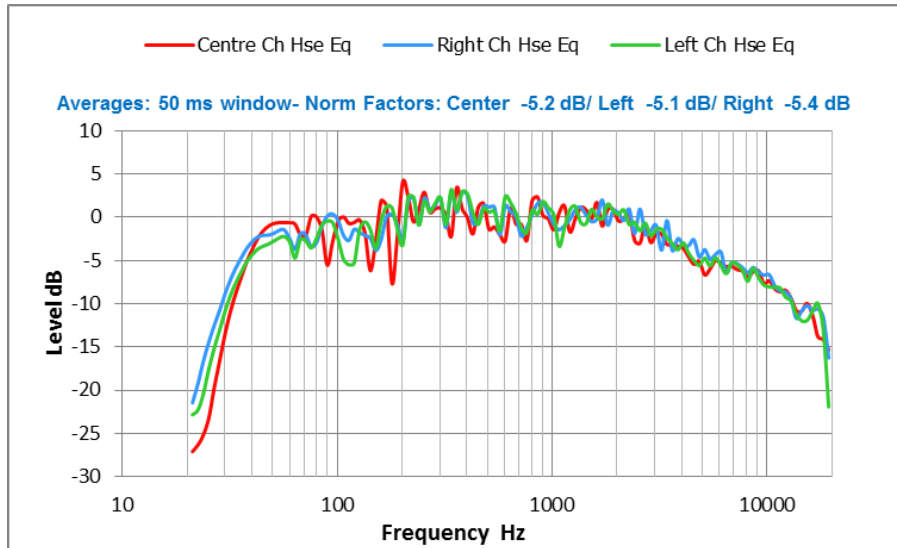

A 50 ms window

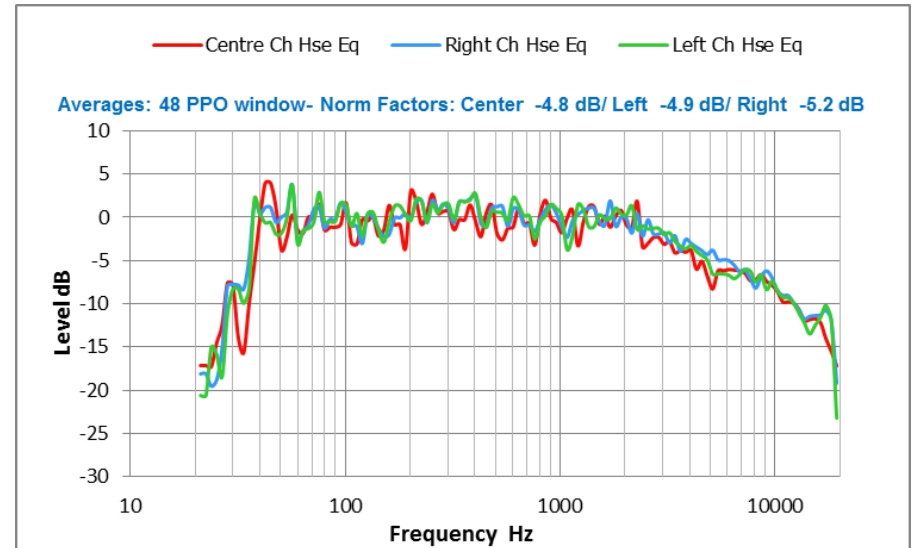

B 48 PPO window

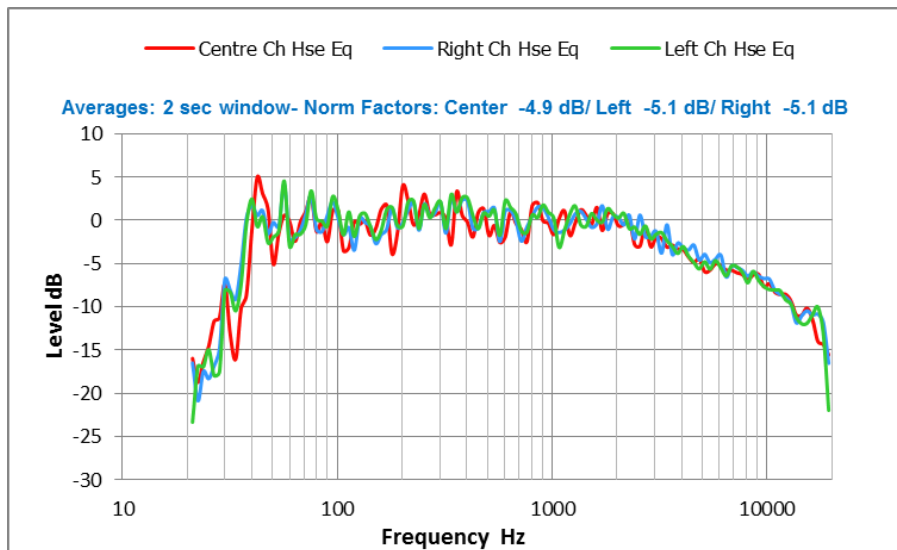

C 2 second window

Figure B 9 A, B and C: Cinema B Comparison of average L,C,R responses with equalization with time windows as noted. Responses are normalized prior to averaging.



16.5.2 Discussion of Results

16.6 LFE Channel

The following figures show responses for the LFE channel based on a 2 s window:

- Figure B 10 compares the response at the reference position with the range of responses over the microphone positions.
- Figure B 11 shows the average response over the listening area and the range of responses over the microphone positions.
- Figure B 12 compares the responses at the five microphone positions.

All responses have been normalized to the average level of the Ref position over the range 40 Hz to 100 Hz.

16.6.1 Discussion of Results

The following points are noted:

- The response of Cinema B's LFE channel appears to be appropriate and shows good overall uniformity.
- The average and reference responses show a strong peak at 28 Hz followed by rapid roll due to a notch at 24 Hz.
- The notch at 24 Hz could perhaps be explained by reference to the theatre dimensions and the microphone positions or a measurement artifact due to truncating low frequency noise. It is not likely to be very audible, but could be indicative of severe peaks elsewhere.
- The upper, low-pass roll off begins around 120 Hz. By contrast, the LFE channel in Venue A shows the lower roll-off beginning at 40 Hz and the low-pass filtering not beginning until above 200 Hz.
- The LFE channel response appears to be much more appropriate for modern soundtracks than Venue A and shows good overall uniformity.

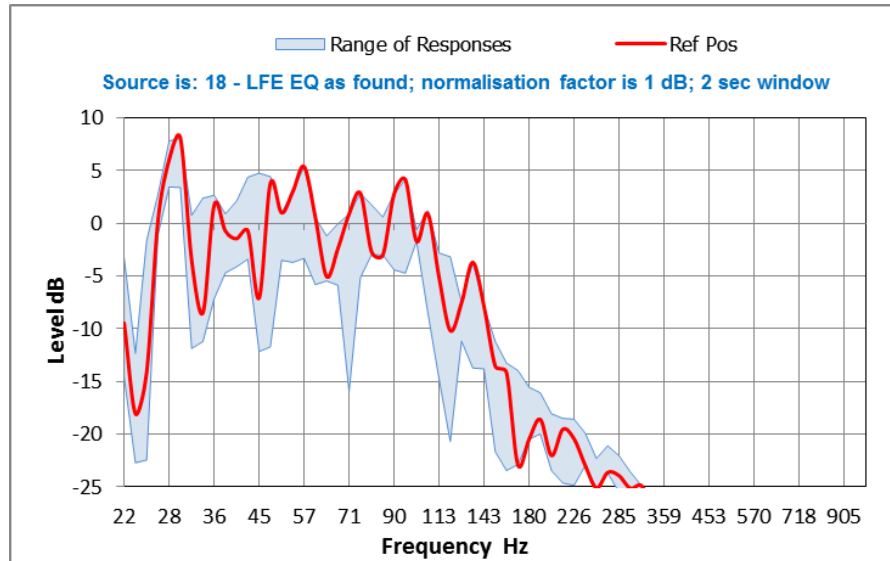

Figure B 10 Cinema B Comparison of extremes in responses over listening area for LFE channel with 2 sec window with equalisation. Responses normalized.

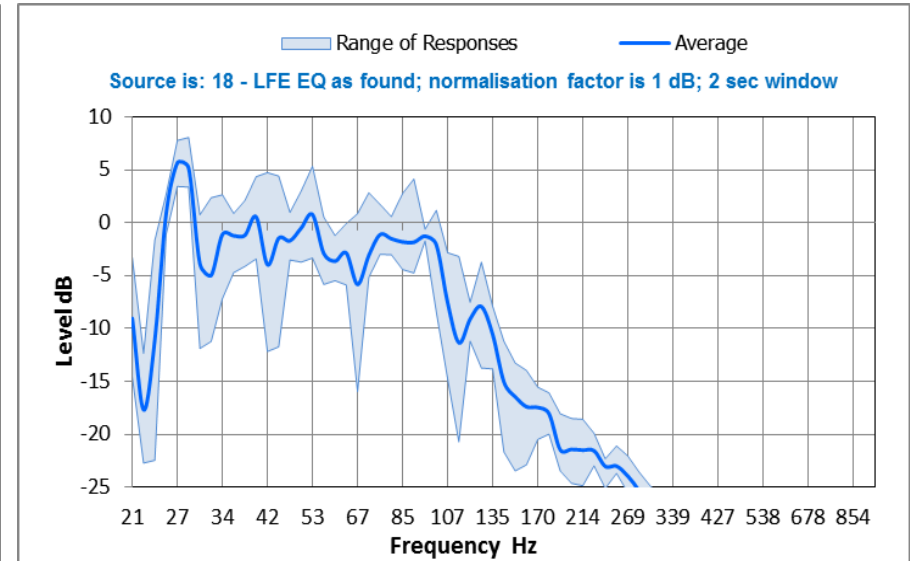

Figure B 11 Cinema B Comparison of average LFE responses with eq with 2 sec window. Responses normalized.

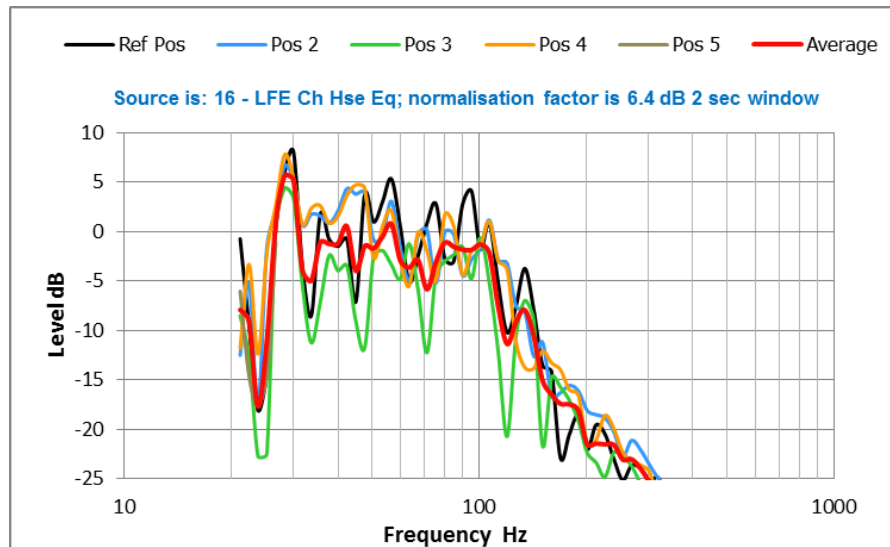

Figure B 12 Cinema B Comparison of individual responses in listening area for LFE channel with 2 sec window. Responses normalized..

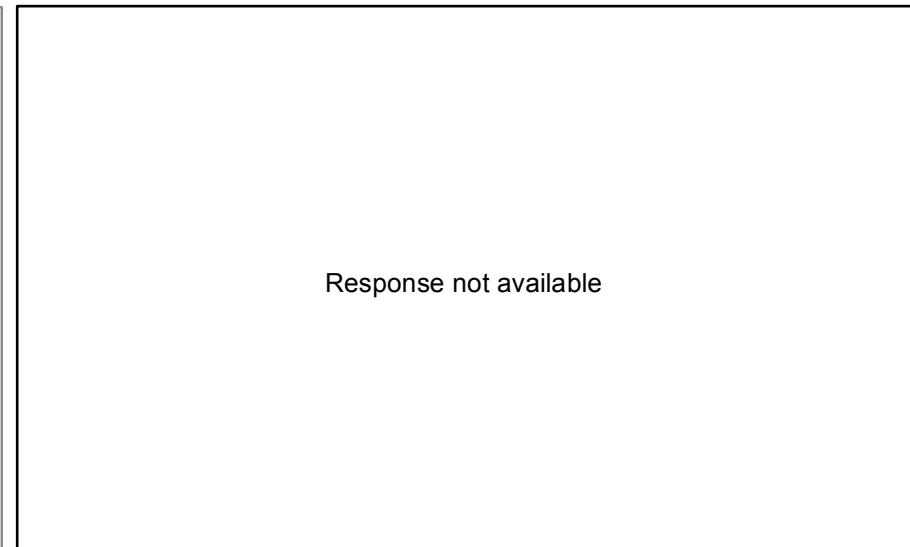

Figure B 13 Response not available

16.7 Surround channels

Figure B 14 compares the response of the left surround system with equalization with the extremes over the listening positions with a 48 PPO window. All responses were normalized to the average level of the Reference position.

The following figures show responses for the Surround channels with equalization as found based on a 48 PPO window:

- Figure B 14 5.1 compares the responses at the reference position of the left and right surround channels.
- Figure B 14 7.1 compares the responses at the reference position of the left side, right side, left rear and right rear surround channels.
- Figure B 15 5.1 compares the average responses of the left and right surround channels.
- Figure B 15 7.1 compares the average responses of the left side, right side, left rear and right rear surround channels.
- Figure B 16 compares the responses for the left surround channel at each position with the average.
- Figure B 17 compares the responses for the right surround channel at each position with the average.
- Figure B 18 compares the responses for the left rear surround channel at each position with the average.
- Figure B 19 compares the responses for the right rear surround channel at each position with the average

16.7.1 Discussion of Results

- The application of the 'standard' X-curve is plainly apparent in the plots.
- Given the high sensitivity of the measurements to the interference when the signal is emanating from multiple sources, the variance in the plots is to be expected and is consistent with theory.
- The responses all show good overall consistency from channel to channel.
- The size of the narrow band peaks and dips in the responses is a result of the many individual sources making up each array being at different distances from each microphone
- The general symmetry of the left and right surround channels in the 5.1 configuration is remarkable, other than a large dip in the left channel at 5.5 kHz.
- In 7.1 mode, the two side-arrays and the two rear-arrays are also shown to be very symmetrical.
- It is interesting to note that the low-frequency response goes to as low as 30 Hz within -3 dB.

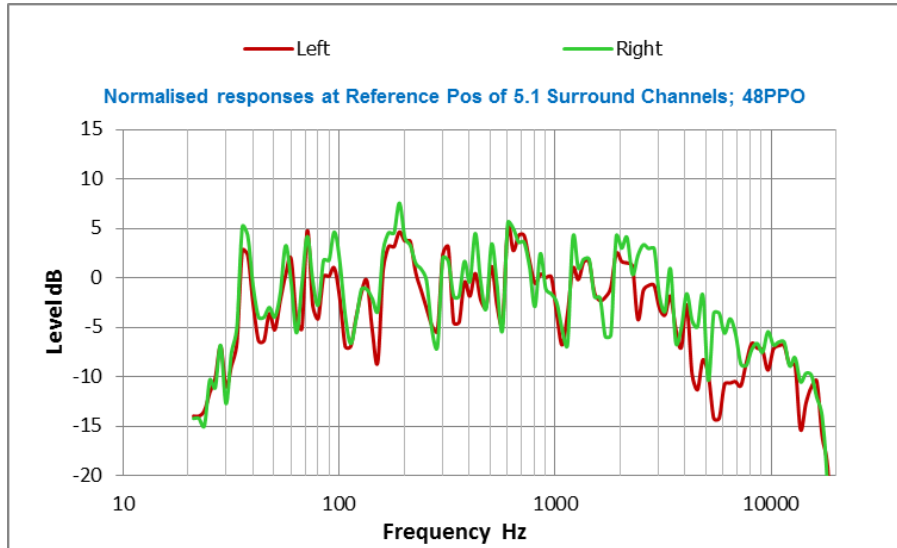

Figure B 14-5.1 Cinema B Comparison of responses at Reference Position for 5.1 Surround channels with 48 PPO window. Responses normalized.

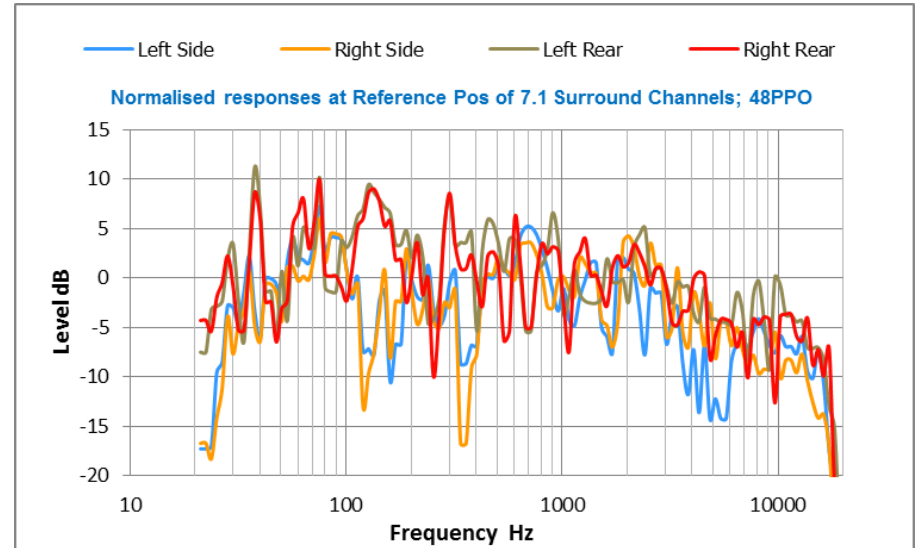

Figure B 14-7.1 Cinema B Comparison of responses at Reference Position for 5.1 Surround channels with 48 PPO window. Responses normalized.

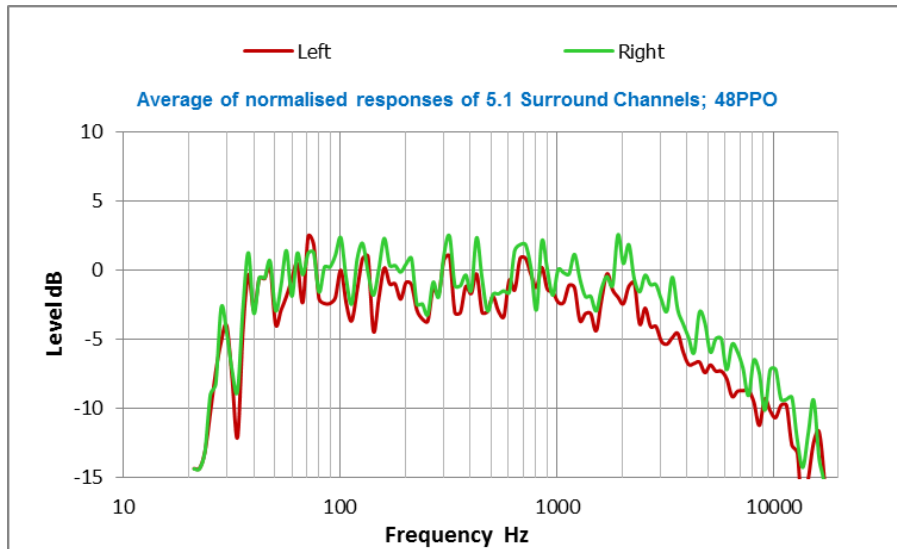

Figure B 15-5.1 Cinema B Comparison of average responses over listening area for Surround channels with 48 PPO window. Responses normalized to average level of Ref position

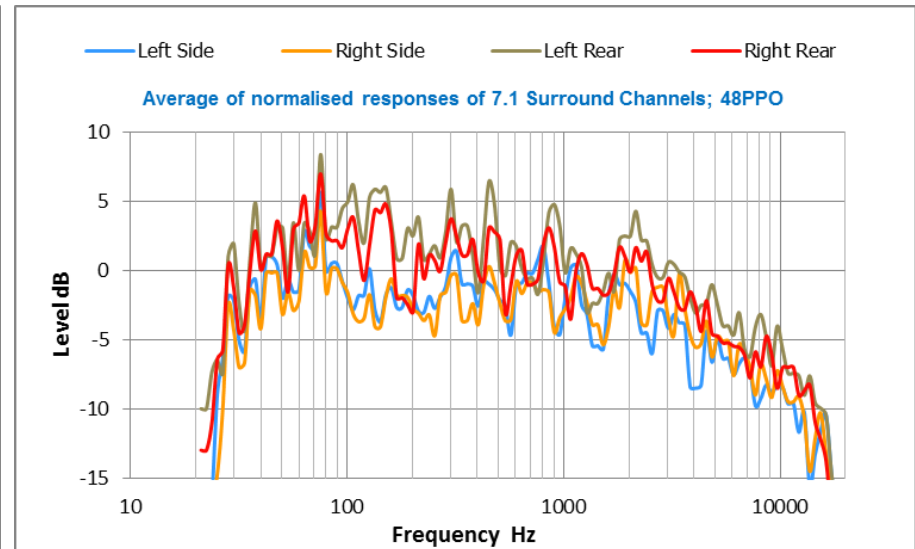

Figure B 15-7.1 Cinema B Comparison of average responses over listening area for Surround channels with 48 PPO window. Responses normalized to average level of Ref position.

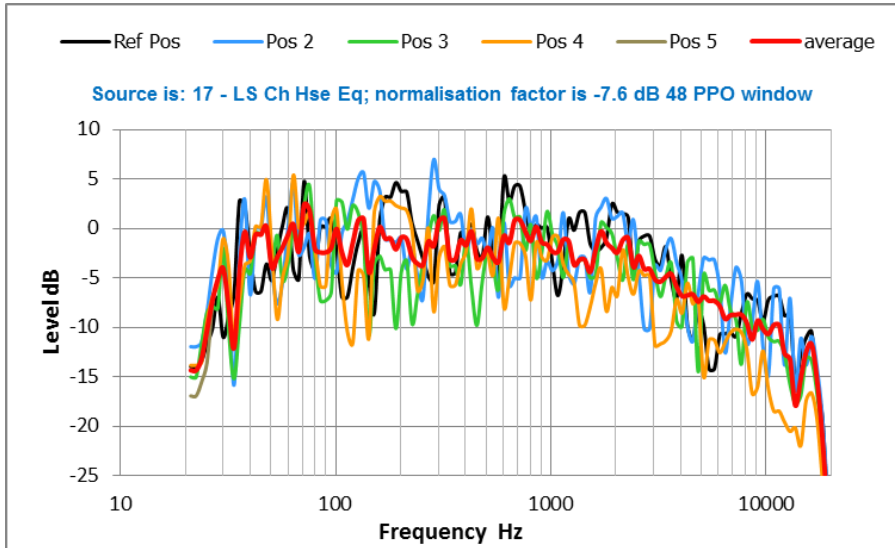

Figure B 16 Cinema B . Comparison of responses in listening area for Left Surround channel with window. Responses normalized to average level of Ref position

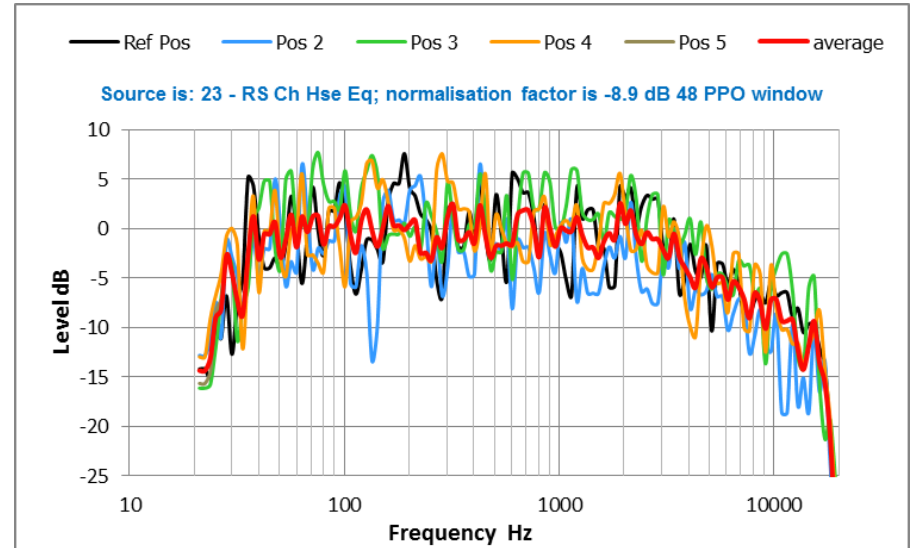

Figure B 17 Cinema B Comparison of responses in listening area for Right Surround channel with window. Responses normalized to average level of Ref position.

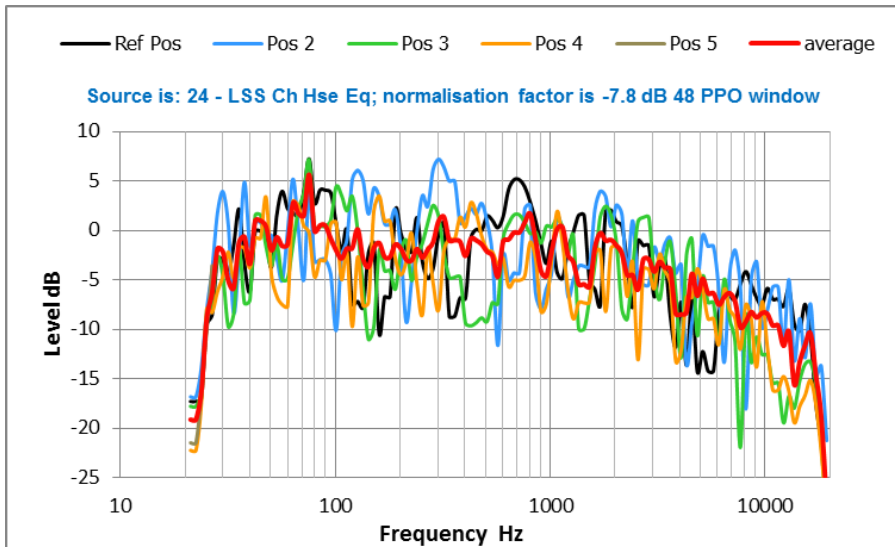

Figure B 18 Cinema B Comparison of responses in listening area for Left Side Surround channel with window. Responses normalized to average level of Ref position.

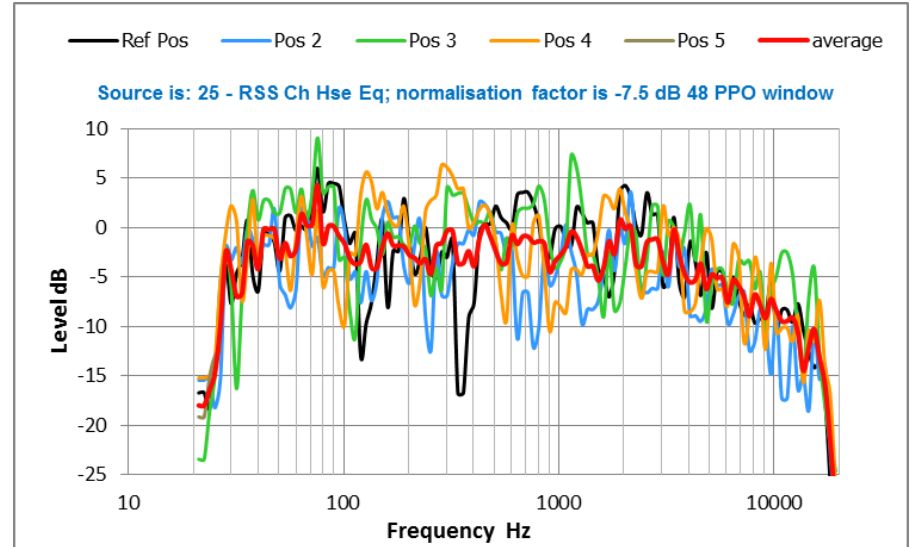

Figure B 19 Cinema B Comparison of responses in listening area for Right Side Surround channel with window. Responses normalized to average level of Ref position.

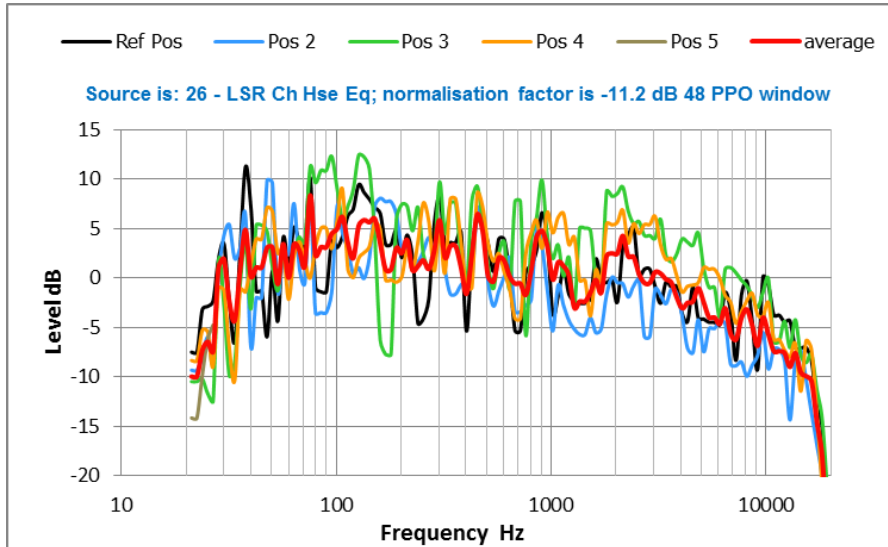

Figure B 20 Cinema B Comparison of responses in listening area for Left Rear Surround channel with window. Responses normalized to average level of Ref position.

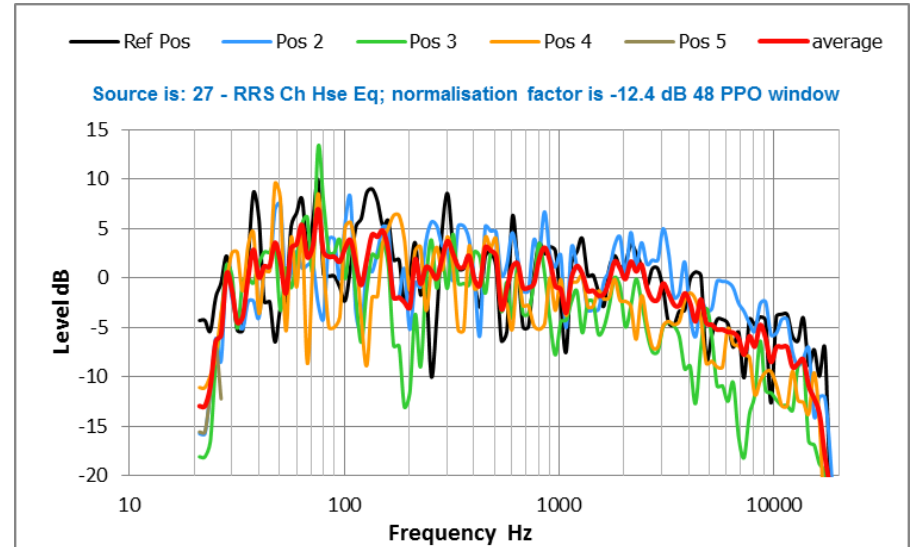

Figure B 21 Cinema B Comparison of responses in listening area for Right Rear Surround channel with window. Responses normalized to average level of Ref position.

16.8 Room Acoustic Measures

Temporal parameters that have been derived from the impulse response of the Centre Channel at the Reference position are shown in the following figures.

- Figure B 20 shows the impulse response filtered to the range of 500 Hz to 4 kHz
- Figure B 21 shows the Schroeder decay curve associated with the impulse response
- Figure B 22 shows the reverberation times computed from the Schroeder decay range of -15 dB to -25 dB.
- Figure B 25 shows the cumulative energy in octave bands.

It is noted that the linear decay range is only 25 dB, as the noise floor of the impulse response is relatively high. It is likely that the difficulties encountered in the initial analysis work regarding bandwidth and the deconvolution algorithm have produced this high noise floor, even with the deconvolution algorithm that was used. It is unlikely that the ambient noise floor in the cinema has caused this high noise floor.

16.8.1 Discussion of Results

- The room is well-controlled, acoustically, and shows no untoward characteristics, with the only reflection of note arriving at 20 ms.
- A reflection at approximately 25 ms delays the cumulative build-up of energy in the 125 Hz and 250 Hz bands.
- The low-frequency control of the temporal behavior is good.

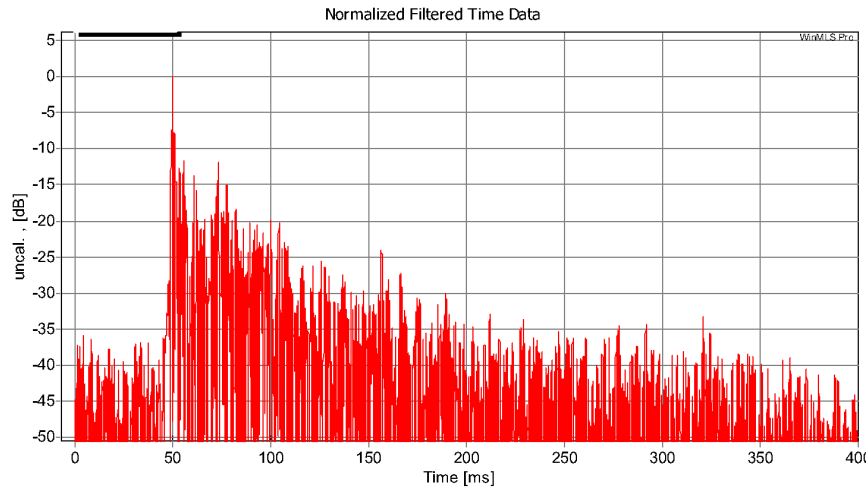

Figure B 22 Cinema B Impulse Response filtered 500 Hz to 4kHz

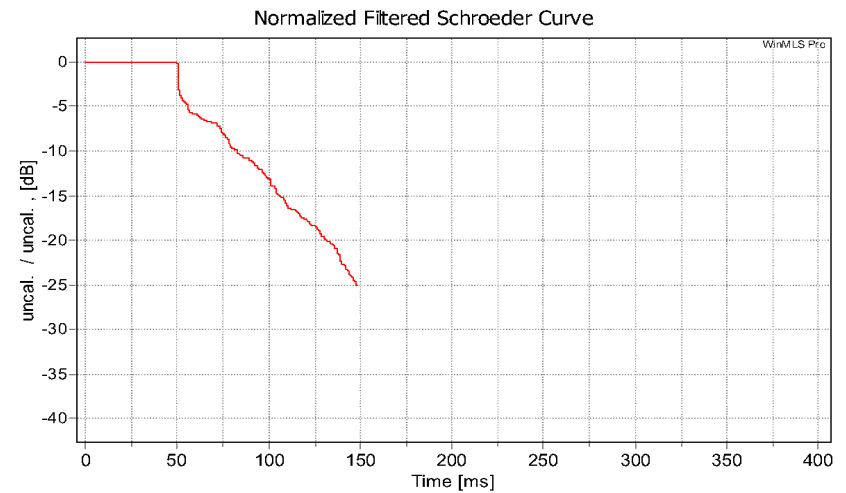

Figure B 23 Cinema B Schroeder decay plot filtered 500 Hz to 4 kHz

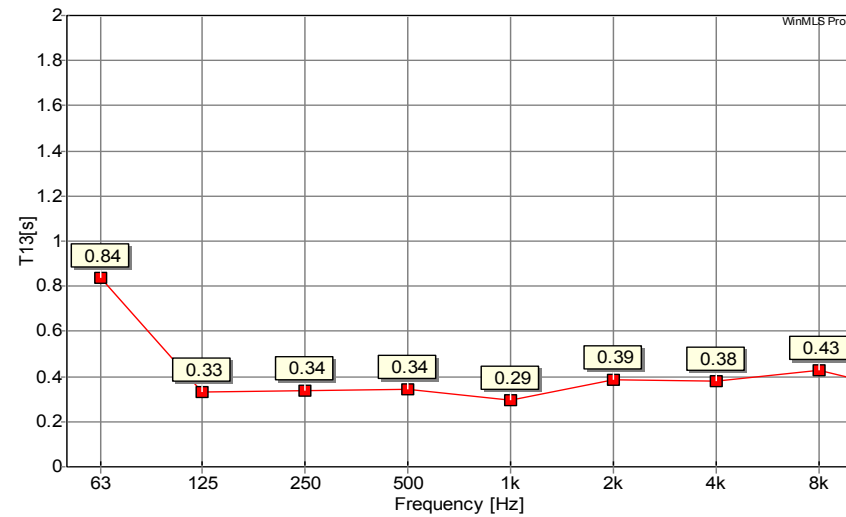

Figure B 24 Cinema B Reverberation times taken over decay range -15 dB to -25 dB

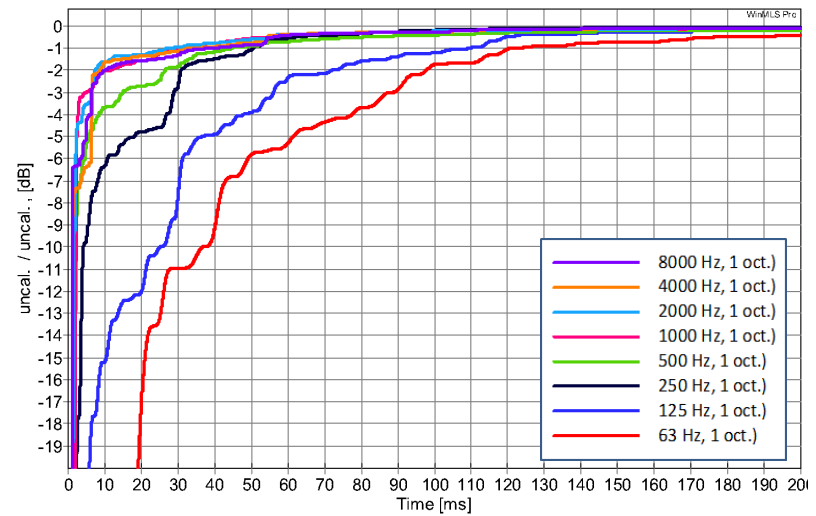

Figure B 25 Cinema B Cumulative energy in octave bands.

17 RESPONSES OF CINEMA C

17.1 Centre Channel

17.1.1 Audience positions

Figure C 1 shows the response at the reference position and the range of responses over all the listening positions with the three time windows. Figure C 2 shows the average response and the range of responses with the three time windows. Figure C 3 compares the average response with the individual position responses

17.1.1.1 Discussion of Results

- The similarity of the three time-window responses above 200 Hz indicates that the sound (at these frequencies) has predominantly arrived within 50 ms.
- Both the reference and average responses show a high-slope roll off below 40 Hz.
- The reference 48 PPO and 2 s responses show an erratic response between 50 Hz and 100 Hz; however no such behavior is evident in the average responses, suggesting that it is a localized effect.

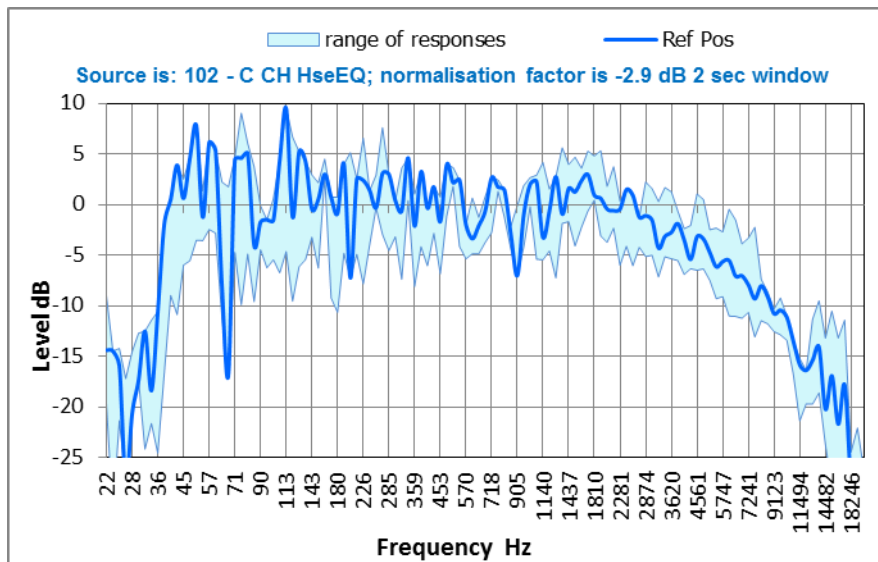
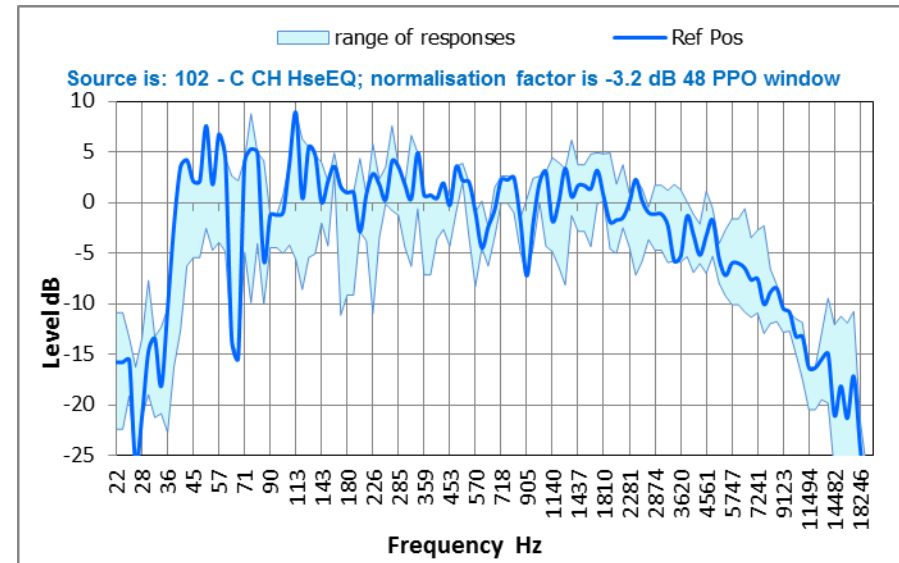
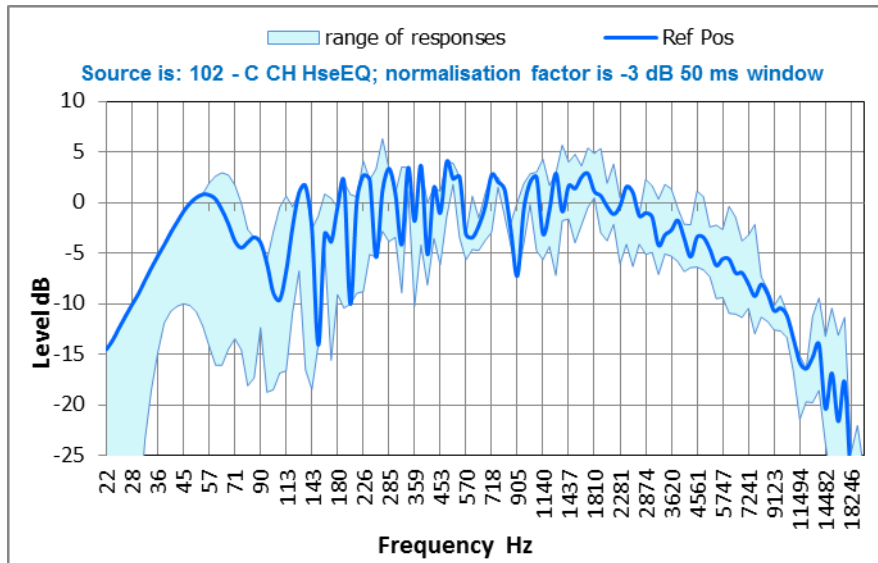

Figure C 1 Cinema C Comparison of mic positions and time windows for given source. Responses have been normalized'.

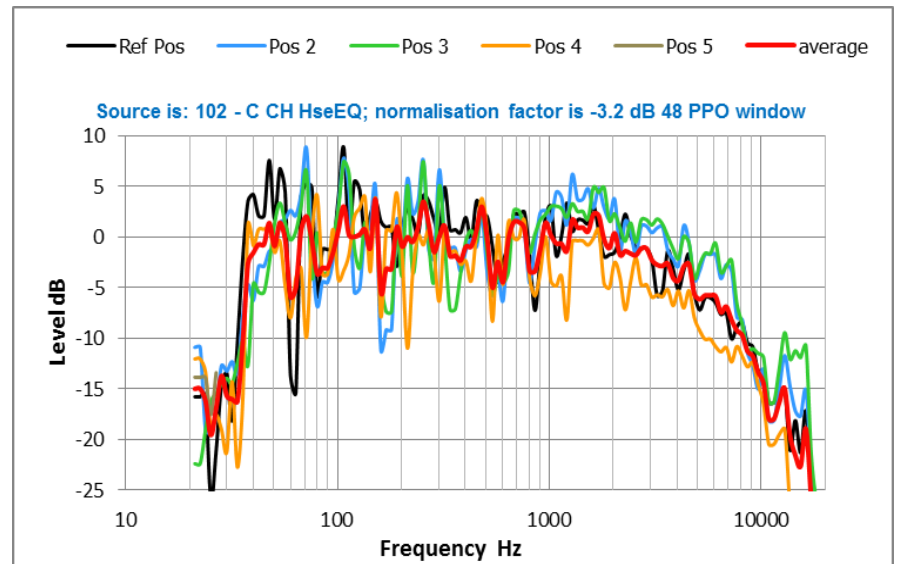
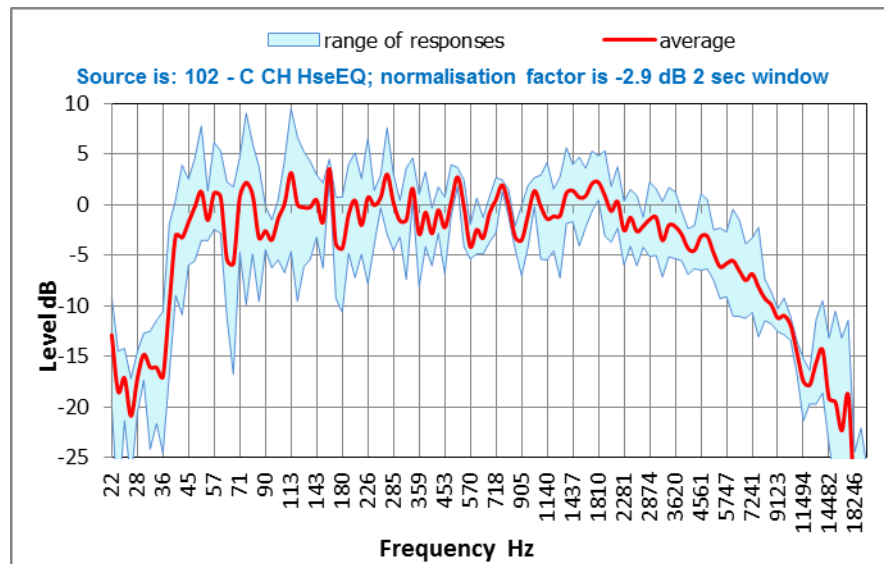
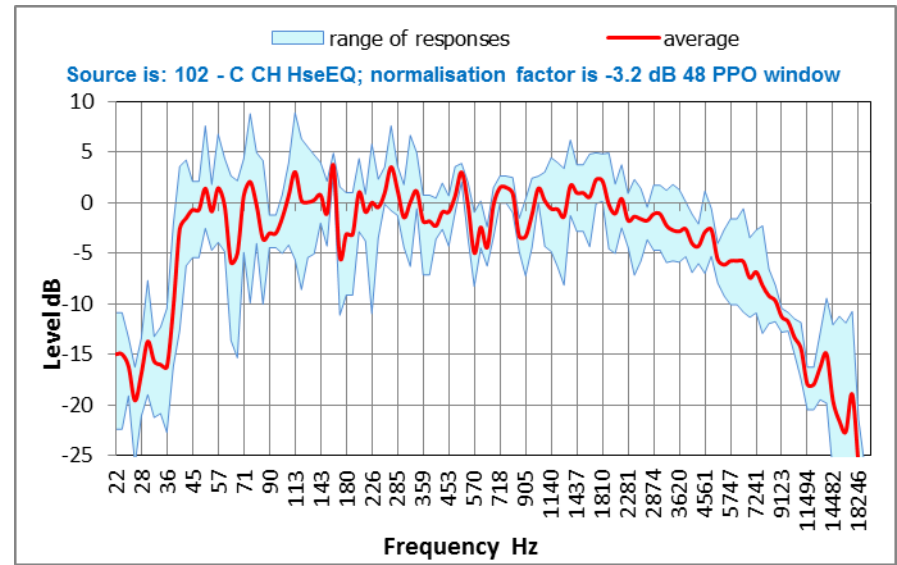
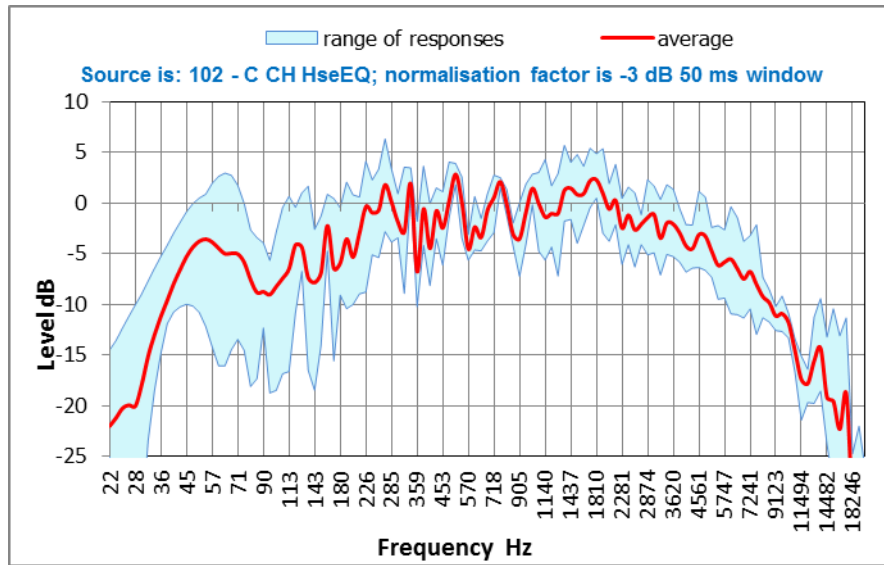

Figure C 2 **Cinema C** Comparison of the average (pressure), maximum and minimum responses and time windows for given source. Responses have been normalized.

Figure C 3 **Cinema C** Comparison of the average (pressure) and positional responses and time windows for 48 PPO. Responses have been normalized.

17.2 Comparison of Center Channel responses with different time windows at reference position

Figure C 6 compares the responses at the reference position of four time windows by referencing the response of each window to the 2 second response. .

Sections of the following responses are not shown due to the lack of resolution resulting from the time/frequency trade-off:

- 10 ms window below 150 Hz
- 50 ms window below 50 Hz

17.2.1 Discussion of Results

- From approximately 800 Hz up, the responses of the 10 ms, 50 ms and 2 second windows are remarkably similar. This indicates that the direct field strongly dominates the measurements, and that reverberant build-up contributes only a small amount of sound to the total energy at these frequencies.
- The change in frequency response that is noted in (**Error! Reference source not found.**) due to the arrival of the reverberant field clearly does not occur here.
- The small differences between the 48 PPO and 10 ms and 2 s responses result from the shorter time window of the 48 PPO responses at these frequencies.
- As expected due to window length, the 10 ms window starts to differ from the 2 s reference around 700 Hz while for the 50 ms window this point is about 200 Hz.

17.3 Effect of equalization on Center Channel and X curve

Figure C 7 compares the equalized Center channel response at the reference position with the published X curve. To show the relative levels, the responses were not normalized.

17.3.1 Discussion of Results

- The high-frequency roll off is substantially greater than that of Venues A or B, and targets the lower tolerance band of the standard X-curve from above about 3 kHz. This would suggest that the reproduced sound will be rather dull.
- It would be interesting to investigate the reasons behind the HF roll-off. Likely reasons are:
 - limitations of the loudspeaker systems
 - dirt in the screen perforations
 - equalization resulting from a subjective assessment based on harshness that may result from the previous two possibilities.
- It is highly unlikely that inaccuracies in the measuring microphones would lead to a calibration error of 5 dB at 10 kHz, which is quite severe.

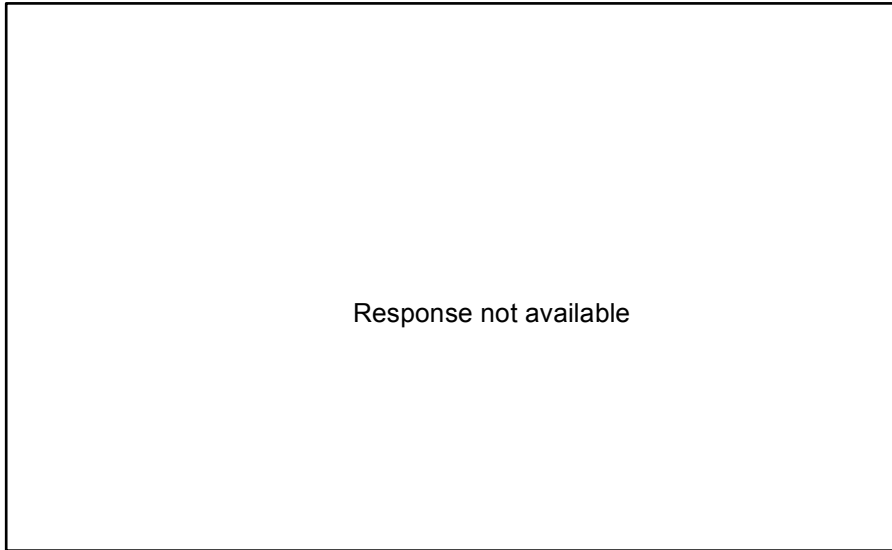

Figure C 4 Response not available

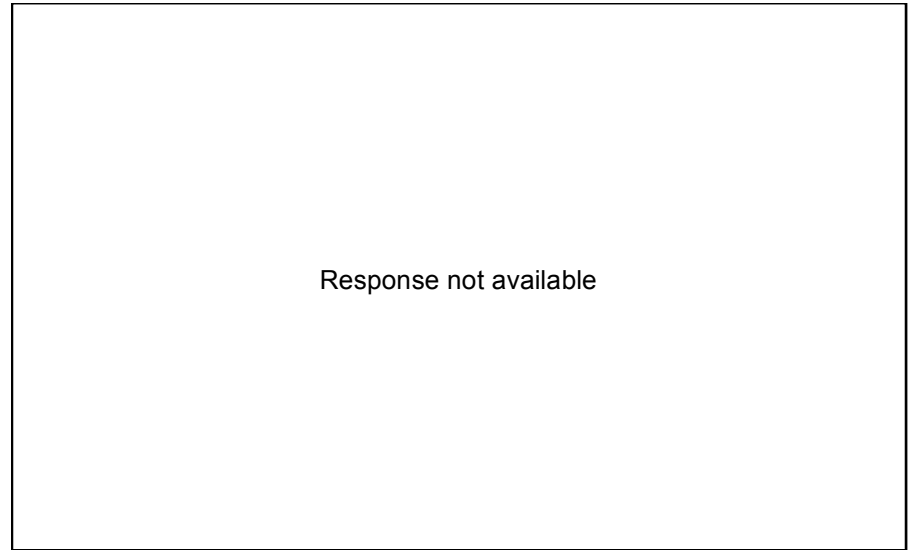

Figure C 5 Response not available

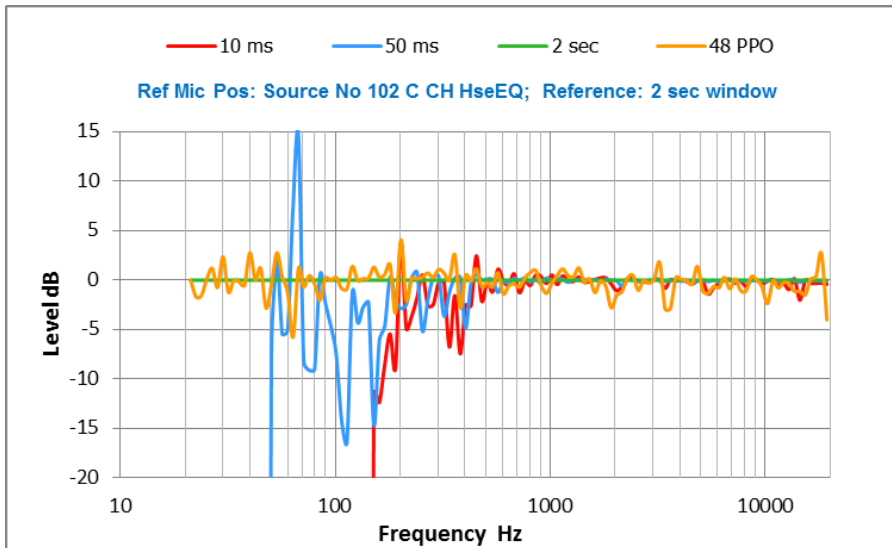

Figure C 6 Cinema C Responses with different windows at ref position Center Channel. NB 10 ms and 50 ms responses are truncated according to the time/frequency limit. normalized.

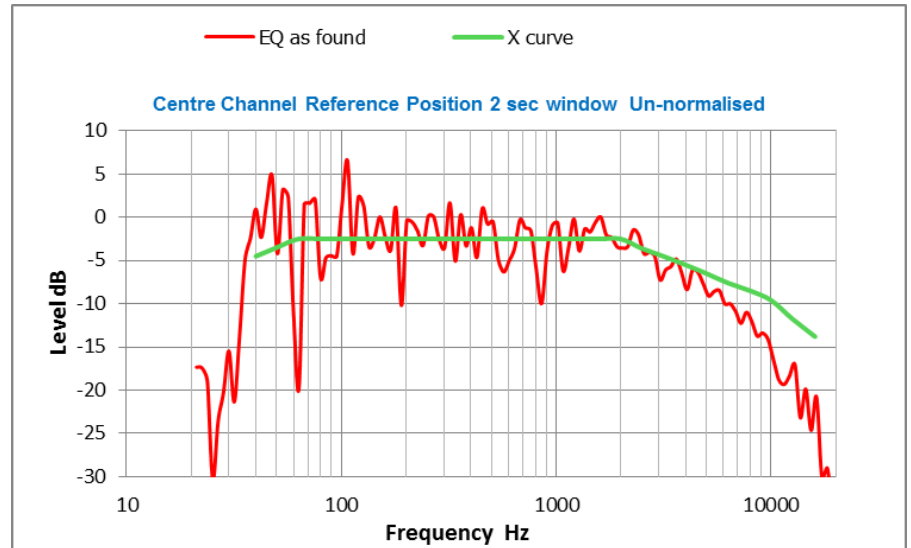

Figure C 7 Cinema C Comparison of responses of Centre Channel with equalization with X curve at reference position. Data is not normalized.



17.4 Comparison of front channels and time windows at Reference position

The responses of the left, center and right channels are shown for the three time windows.

- Figure C 8 A/B/C compare the responses at the reference position of the left, center and right channels.
- Figure C 8 D shows the overall range of responses of the three channels.
- Figure C 9 A/B/C compares the average response of the three channels.

17.4.1 Discussion of Results

- The responses show nothing particularly unusual
- The general similarity of the screen-channel responses is reasonable below 1 kHz.
- Above 1 kHz the three channels are very similar in both the reference position and the average.
- At the reference position, the responses of the left and right channels around 50 Hz to 200 Hz deviate from the response of the center channel, which is expected, but they show substantially less similarity between themselves than the LCR systems in Cinema B.
- The average 50 ms response of each channel shows a depression in the 100 Hz to 200 Hz range, which is also present to a lesser extent in some of the 48 PPO and 2 s responses. This suggests that a phase cancellation from an early reflection is affecting the overall radiated power of the system.

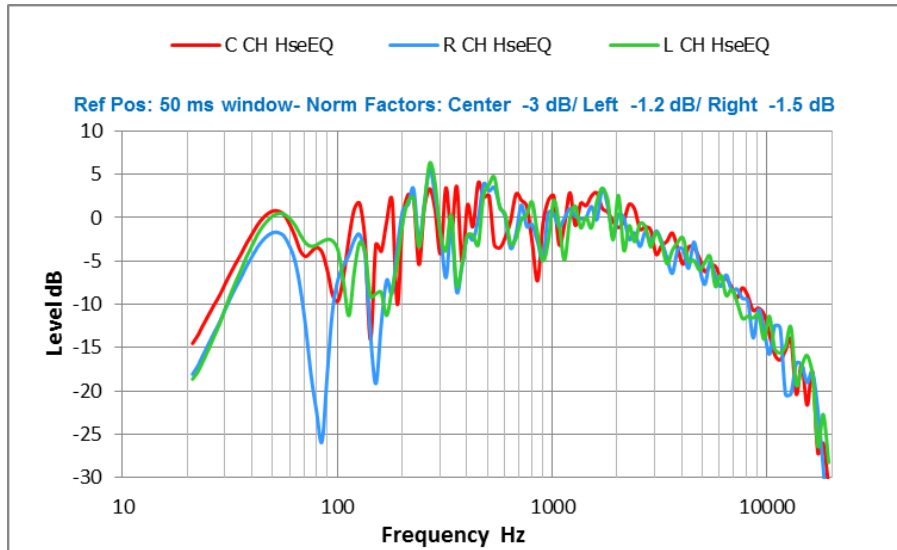

A 50 ms window.

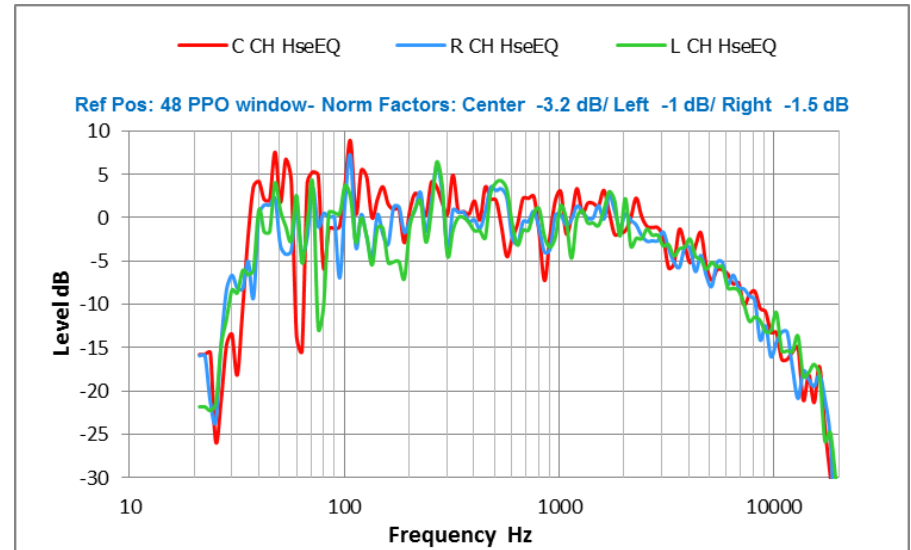

B 48 PPO window.

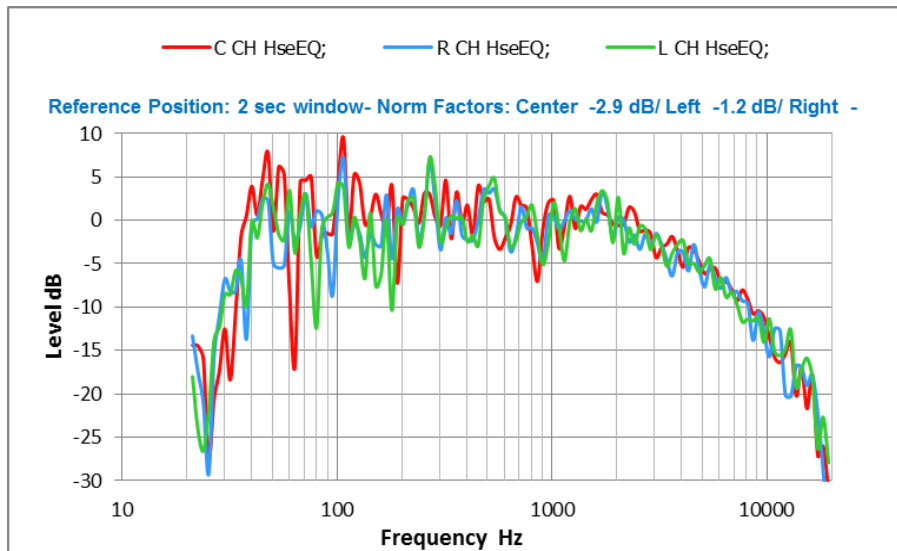

C 2 second window .

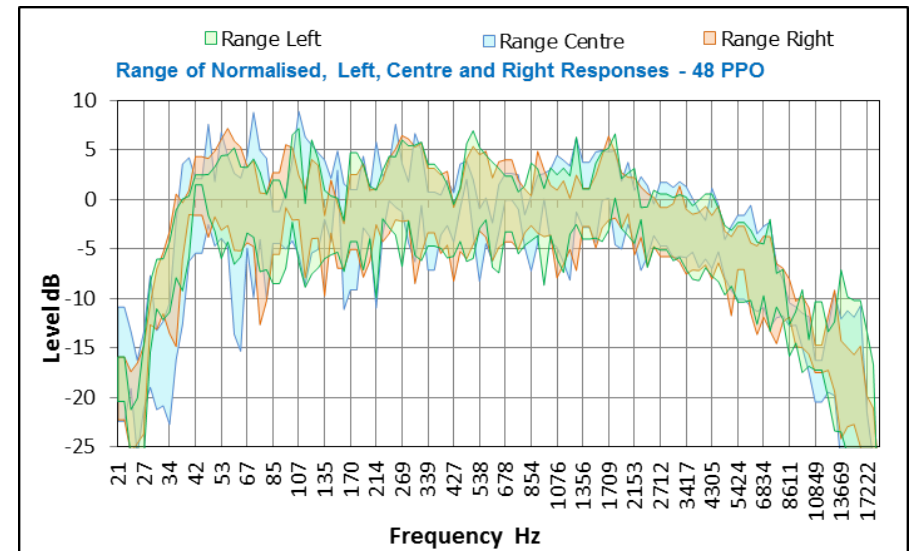

D 48 PPO window.

Figure C 8 A, B and C: Cinema C Comparison of L,C,R responses with equalization at reference position with time windows as noted. Responses are normalized. D: Comparison of maximum and minimum extremes over listening positions.. Responses are normalized.

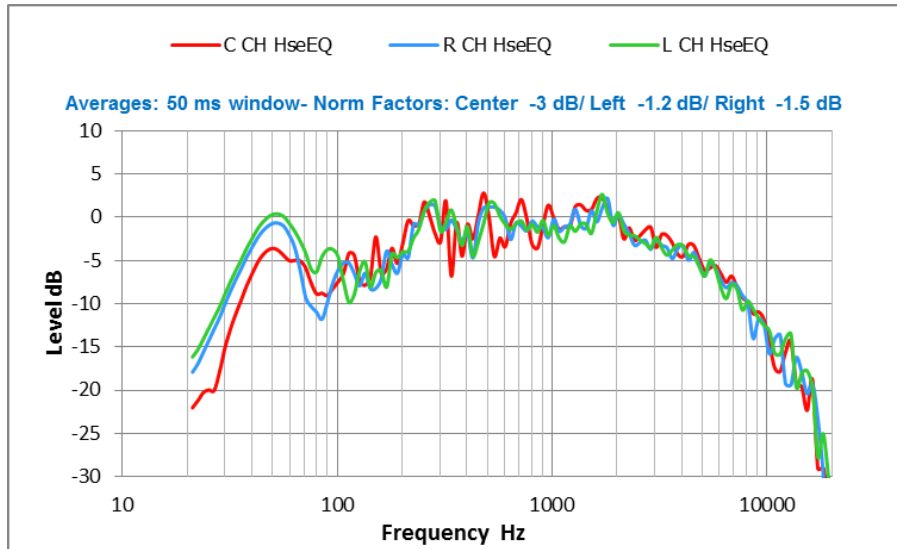

A 50 ms window

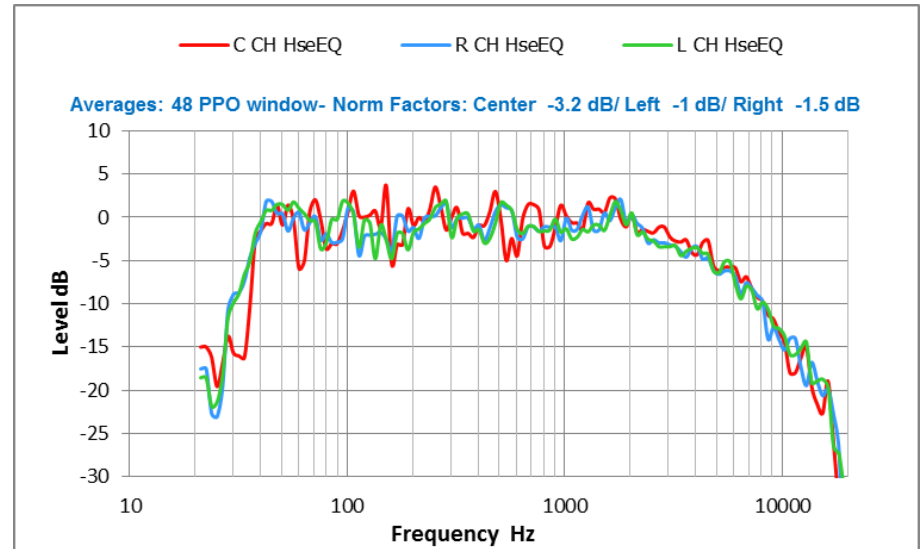

B 48 PPO window

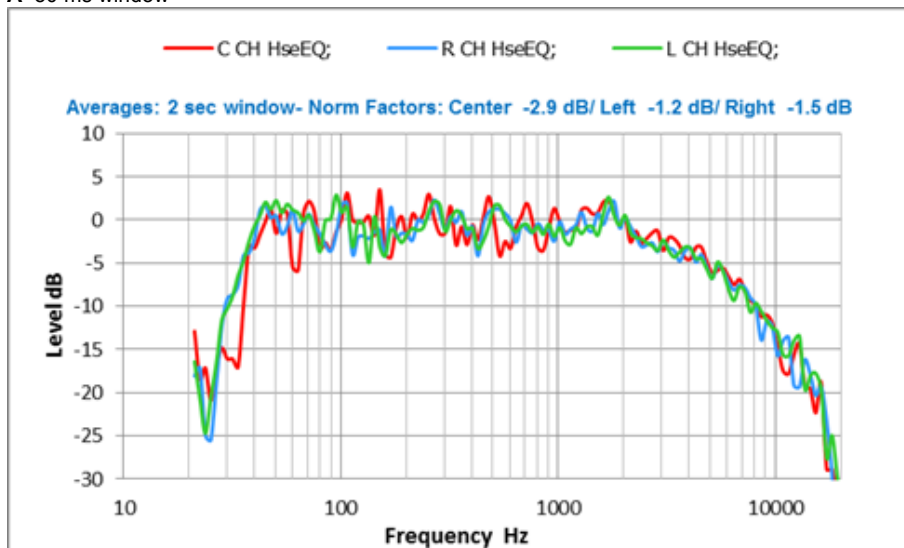

C 2 second window

Figure C 9 A, B and C: Cinema C Comparison of average L,C,R responses with equalization with time windows as noted. Responses are normalized prior to averaging.

17.5 LFE Channel

The following figures show responses for the LFE channel based on a 2 s window:

- Figure C 10 compares the reference response with the range of responses over the microphone positions.
- Figure C 11 shows the average response over the listening area and the range of responses over the microphone positions.
- Figure C 12 compares the responses at the five microphone positions.

All responses have been normalized to the average level of the Ref position over the range 40 Hz to 100 Hz.

17.5.1 Discussion of Results

- The plots show a very ragged LFE response but which extends down to 20 Hz and is within ± 6 dB limits up to around 300 Hz. The response reaches a peak in the band from 35 to 60 Hz and has a smaller peak around 25 Hz.
- The range of responses and the overall shape of the individual responses follow closely the shape of the average response, suggesting a poor overall response.
- Although the LF extension is very good, the overall uniformity of the response is not.
- As in Cinema A, it appears that no low-pass filter is being employed to roll off frequencies above 120 Hz that the current standards recommend.
- In general, it is a poor LFE channel response.

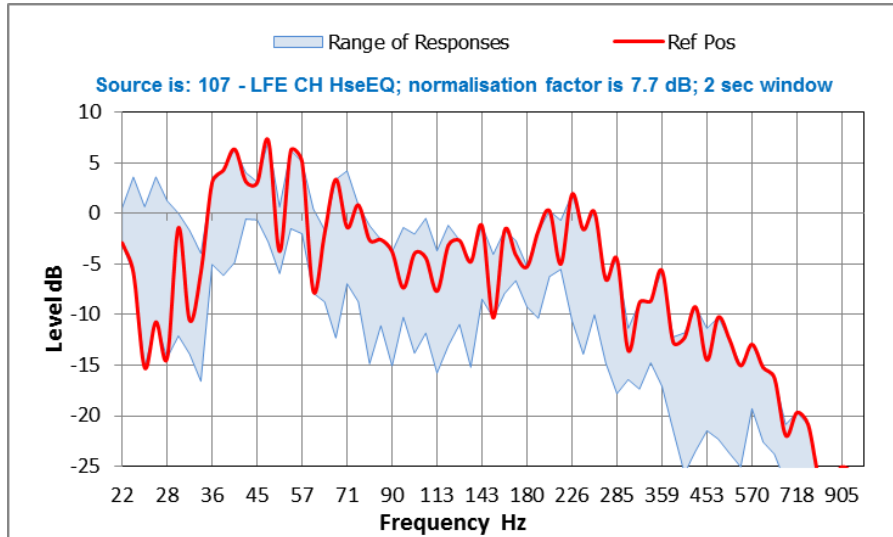

Figure C 10 Cinema C Comparison of extremes in responses over listening area for LFE channel with 2 sec window with equalisation. Responses normalized.

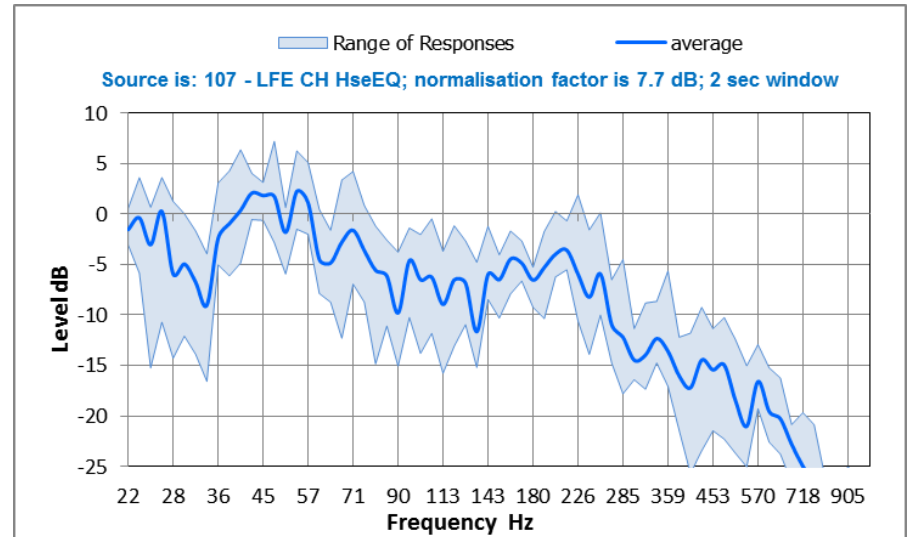

Figure C 11 Cinema C Average and range of LFE responses with eq with 2 sec wom. Responses normalized.

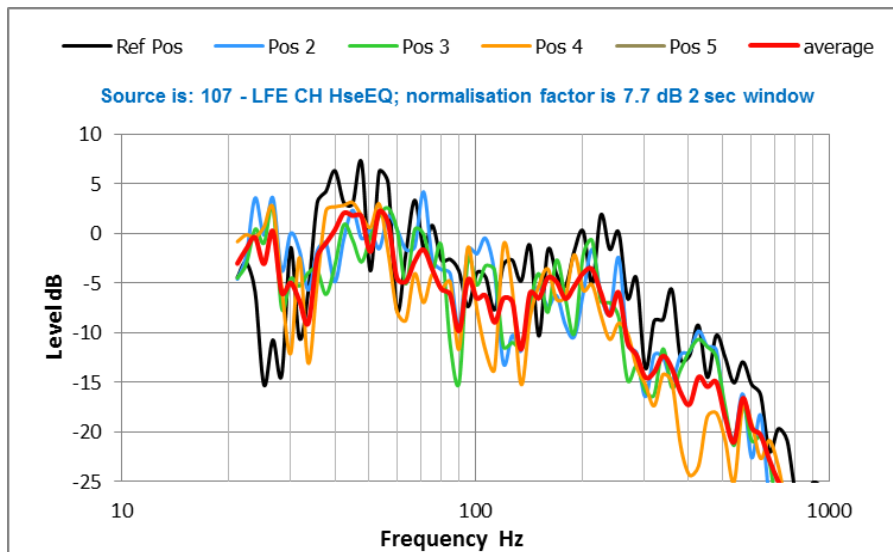

Figure C 12 Cinema C Comparison of individual responses in listening area for LFE channel with 2 sec window. Responses normalized..

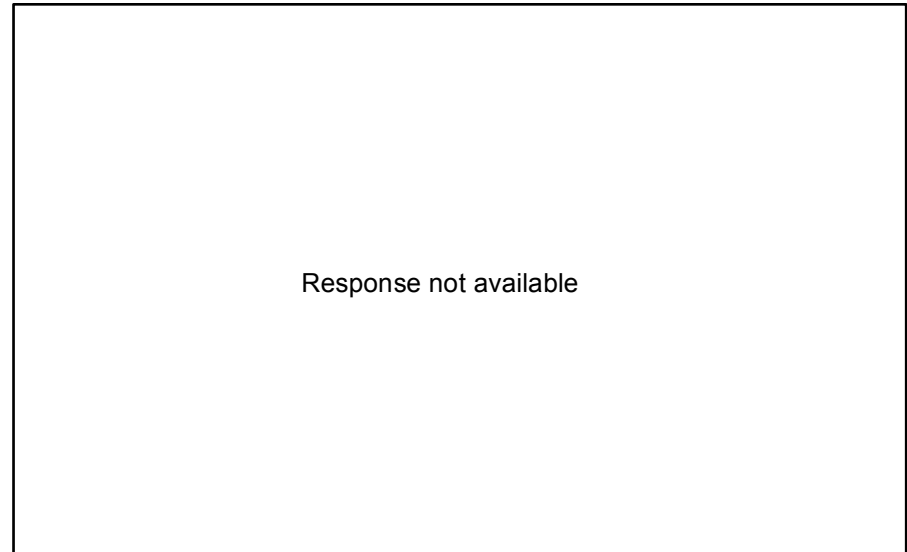

Figure C 13 Response not available

17.6 Surround channels

The following figures show responses for the left and right Surround channels with equalization based on a 48 PPO window:

- Figure C 14 compares the responses at the reference position.
- Figure C 15 compares the average responses of the two channels.
- Figure C 16 compares the responses at each position with the average for the left channel.
- Figure C 17 compares the responses at each position with the average for the right channel.

All responses were normalized to the average level of the Reference position.

17.6.1 Discussion of Results

- The similarity of left and right channels to is too high to be believable for in-room measurements, especially when multiple sources are involved and probably results from a labeling error on site.
- The surround spectral responses are not particularly smooth.
- The low-frequency response extends down to only about 60 Hz, which is on the high side of the ST202 recommendations and a whole octave higher than the responses in Cinema B. It is also considerably higher than the 40 Hz roll-off break in Cinema A.

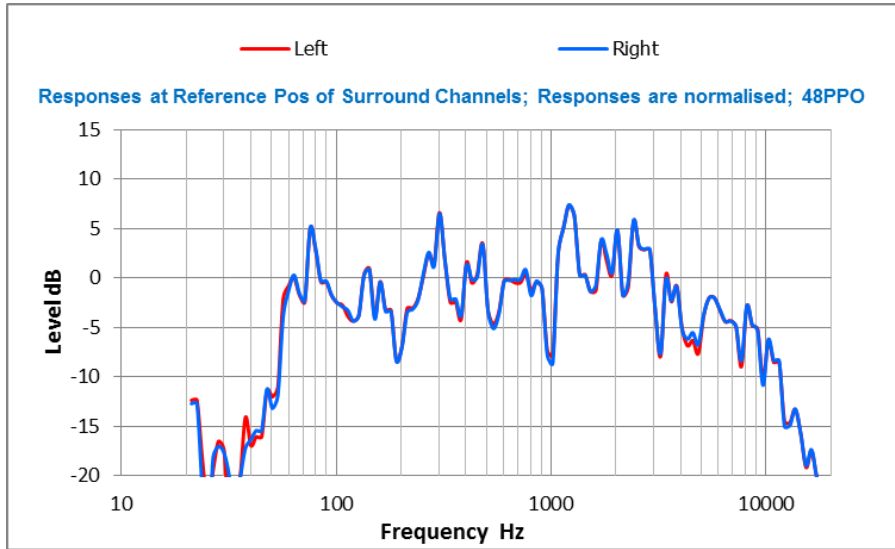

Figure C 14 Cinema C Comparison of responses at Reference Position for Surround channels with 48 PPO window. Responses normalized to average level of Ref position.

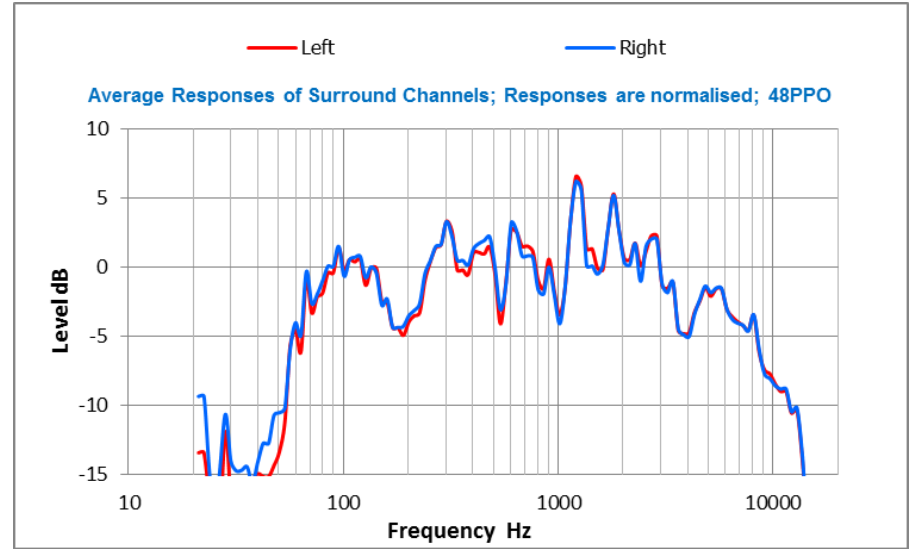

Figure C 15 Cinema C Comparison of average responses over listening area for Surround channels with 48 PPO window. Responses normalized to average level of Ref position.

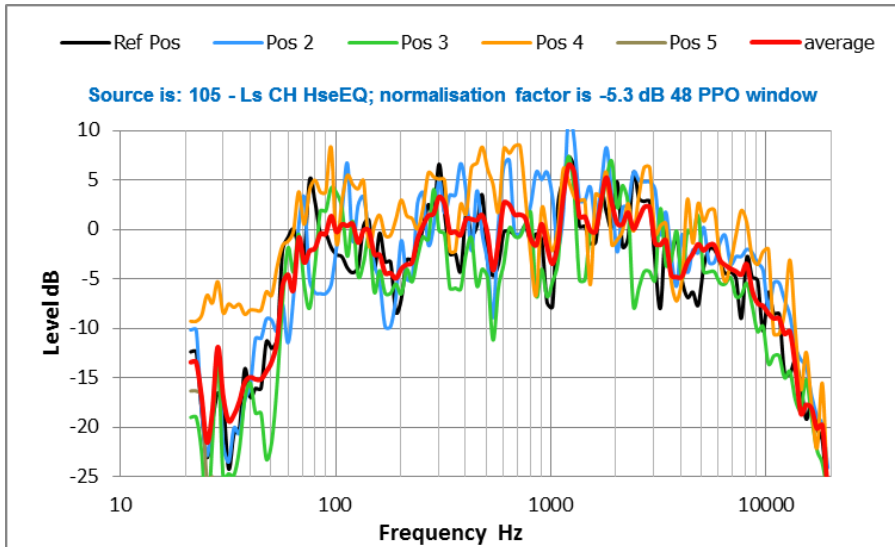

Figure C 16 Cinema C . Comparison of responses in listening area for Left Surround channel with window. Responses normalized to average level of Ref position.

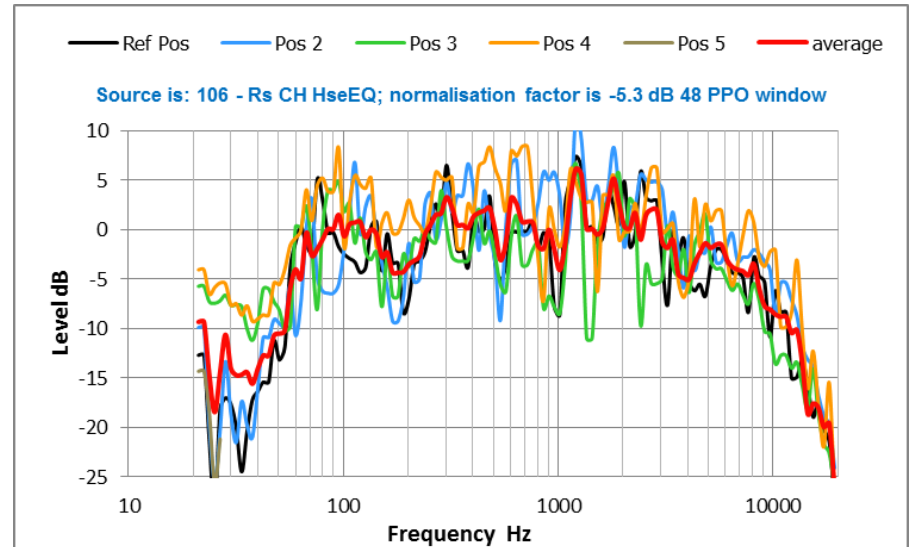

Figure C 17 Cinema C Comparison of responses in listening area for Right Surround channel with window. Responses normalized to average level of Ref position.

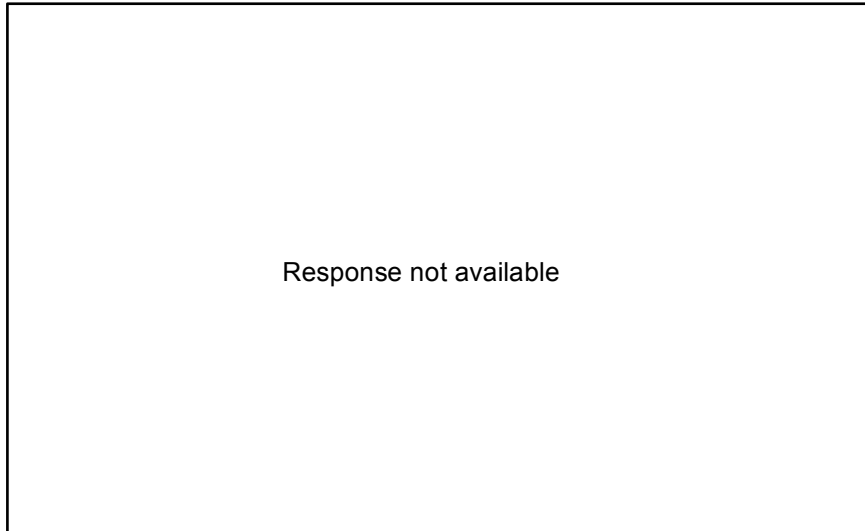

Figure C 18 Response not available

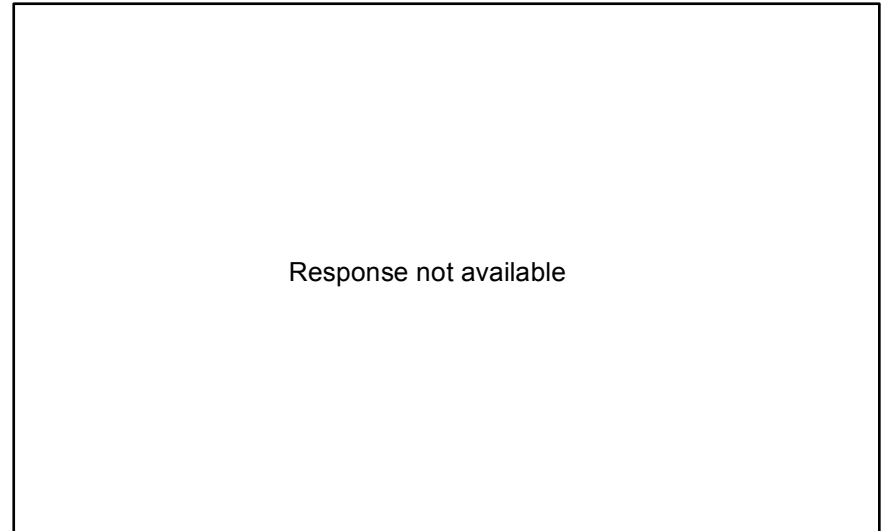

Figure C 19 Response not available.

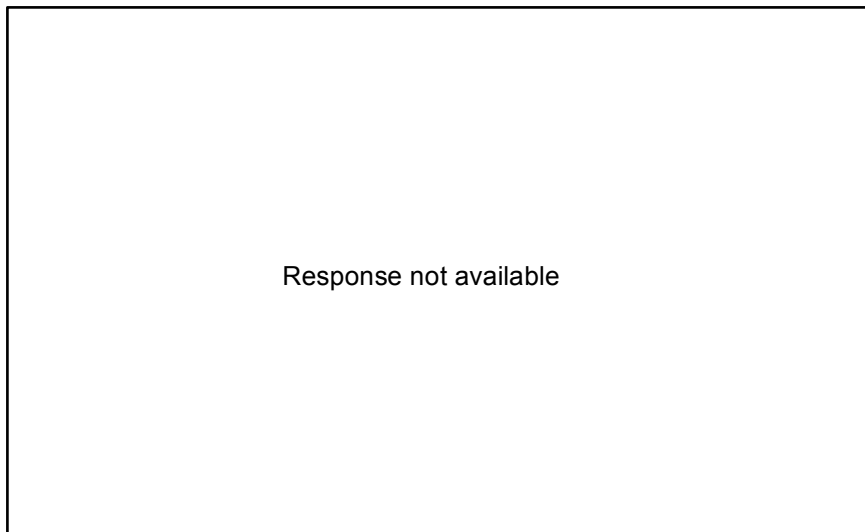

Figure C 20 Response not available

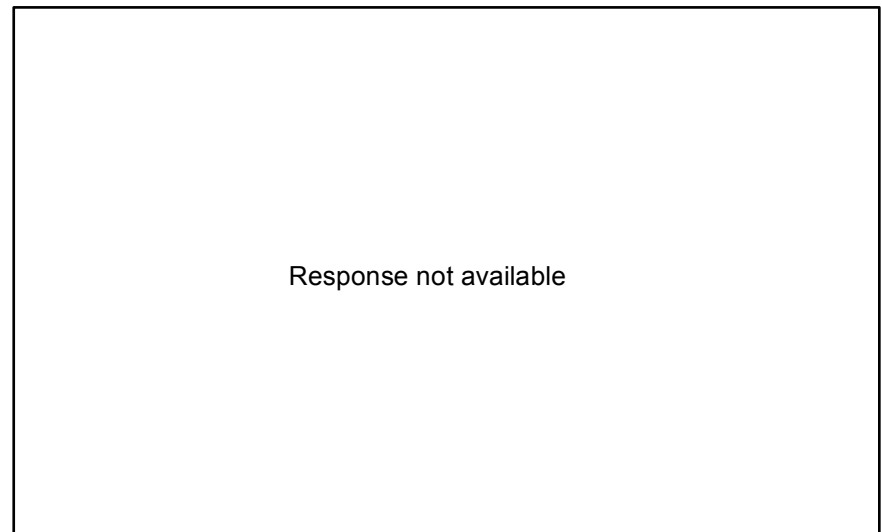

Figure C 21 Response not available

17.7 Room Acoustic Measures

Temporal parameters that have been derived from the impulse response of the Centre Channel at the Reference position are shown in the following figures.

- Figure C 22 shows the impulse response filtered to the range of 500 Hz to 4 kHz
- Figure C 23 shows the Schroeder decay curve associated with the impulse response
- Figure C 24 shows the reverberation times computed from the Schroeder decay range of -20 dB to -40 dB.
- Figure C 25 shows the cumulative energy in octave bands.

17.7.1 Discussion of Results

- The impulse response shows a number of problematic features:
 - there is a strong arrival 30 ms after the direct field arrives
 - the decay of the sound field is not smooth, with a group of strong arrivals being evident some 140 ms after the direct field
- The Schroeder decay curve also manifests these two problems, showing an uneven decay.
- The reverberation times are excessively long below 1 kHz with a hump around 250 Hz and an unduly long decay in the 63 Hz band.
 - The RT at 63 Hz is four times the RT at 1 kHz, which is not within generally expected limits.
 - The RT doubles from 500 Hz to 250 Hz, which is a huge jump for a single octave.
- The decay time performance of the room is not what is expected for the reproduction of modern cinema soundtracks, and is probably inadequate for good intelligibility during complex mixes. Low frequencies are likely to sound muddy with speech showing signs of chestiness.
- The cumulative energy plots show discontinuities due to the reflections. The slow rise of the 250 Hz CE plot after 50 ms is due to the high RT.
- The CE plots for 63 Hz and 125 Hz show a long pause of 40 ms in the buildup occurring after 60 ms, further adding weight to the assessment of low frequency muddiness.

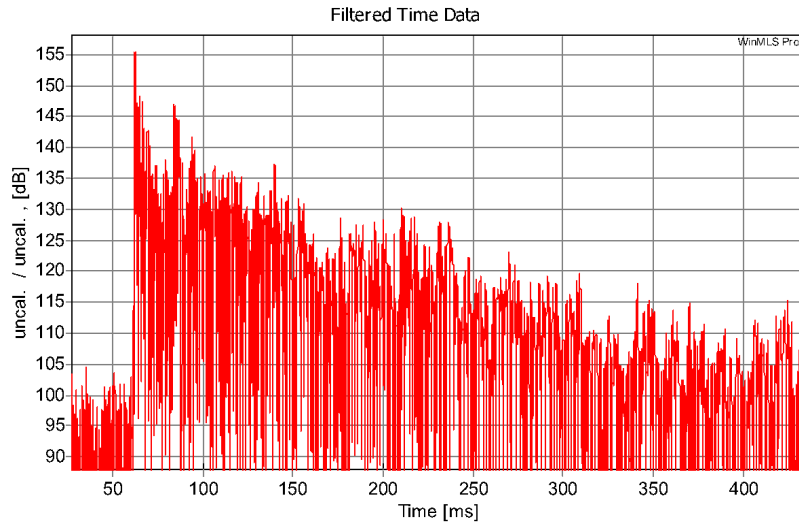

Figure C 22 Cinema C Impulse Response filtered 500 Hz to 4

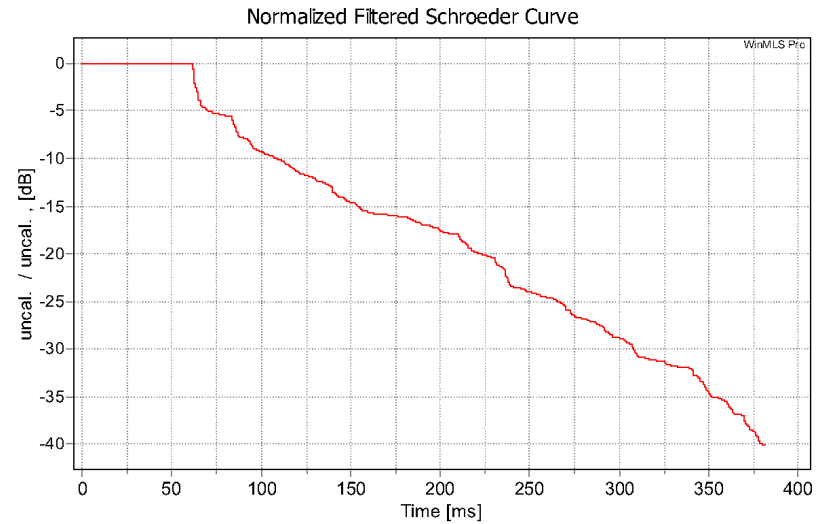

Figure C 23 Cinema C Schroeder decay plot filtered 500 Hz to 4 kHz

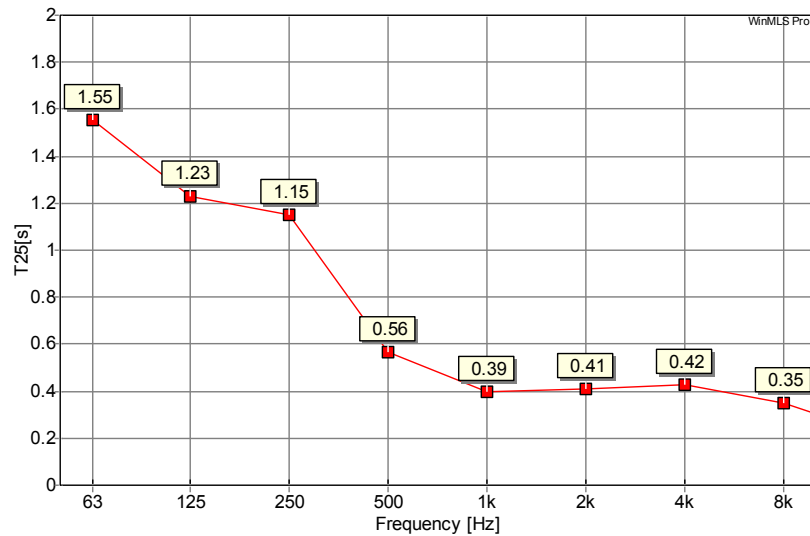

Figure C 24 Cinema C Reverberation times taken over decay range -15 dB to -25 dB

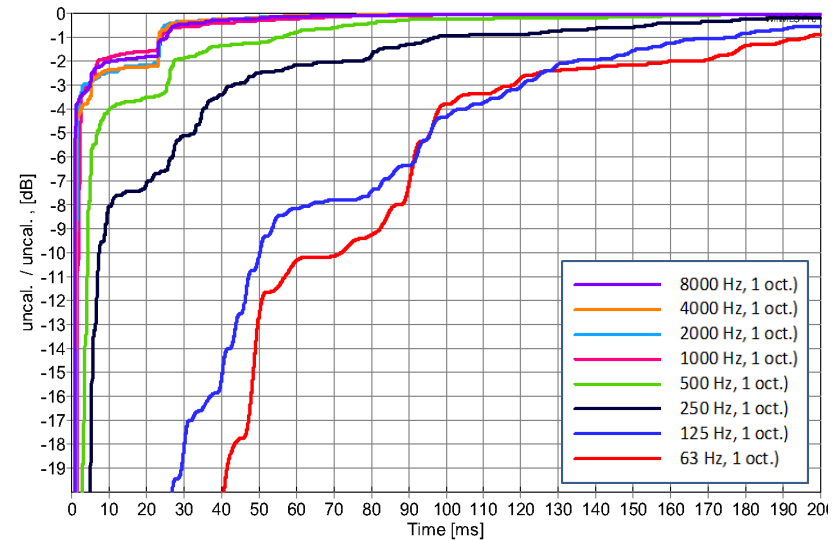

Figure C 25 Cinema C Cumulative energy in octave bands.

18 RESPONSES OF CINEMA D

18.1 Centre Channel

18.1.1 Audience positions

Figure D 1 shows the response at the reference position and the range of responses over all the listening positions with the three time windows. Figure D 2 shows the average response and the range of responses with the three time windows. Figure D 3 compares the average response with the individual position responses

18.1.1.1 Discussion of Results

- The similarity of the three time-window responses above 200 Hz indicates that the sound (at these frequencies) has predominantly arrived within 50 ms.
- There is a noticeable difference between the reference and average responses above 200 Hz.
- The response at the reference position between 200 Hz and 2 kHz is comparatively ragged. Given that the response raggedness appears in all time windows, it is likely that the direct field of the loudspeaker would show strong similarities to the responses shown.
- The average and reference 48 PPO and 2 s responses all show a significant response hump between about 60 Hz and 140 Hz which was not evident in Venues A, B, or C.
- The lower limit of the screen-channel response seems to be about 40 Hz, with a steep roll off below it. This is reasonably consistent with the other cinemas.
- The high-frequency response closely follows the X-curve until 10 kHz but then gently falls away.

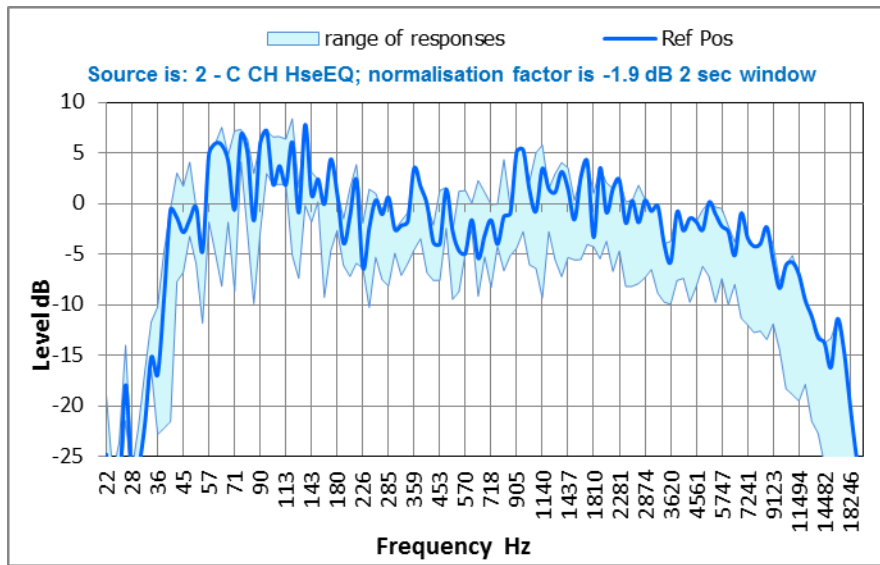
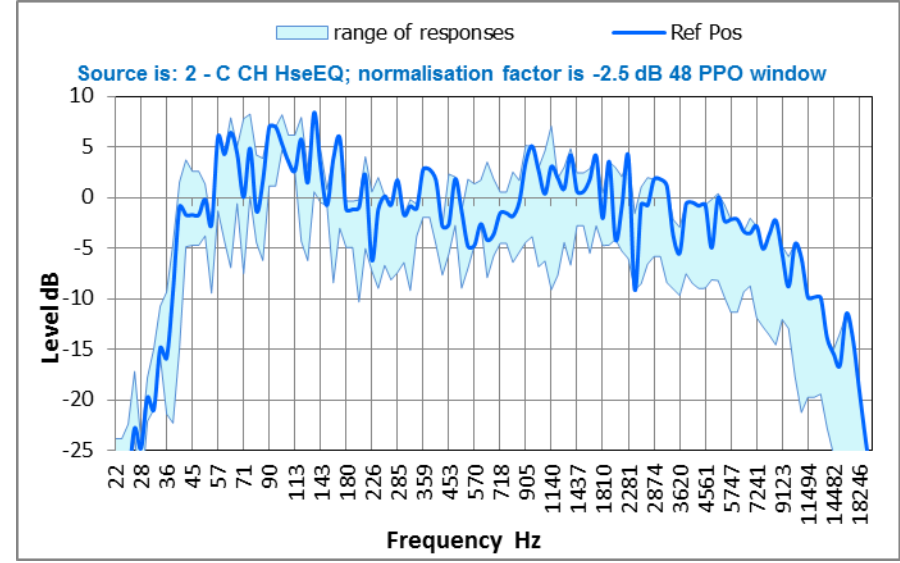
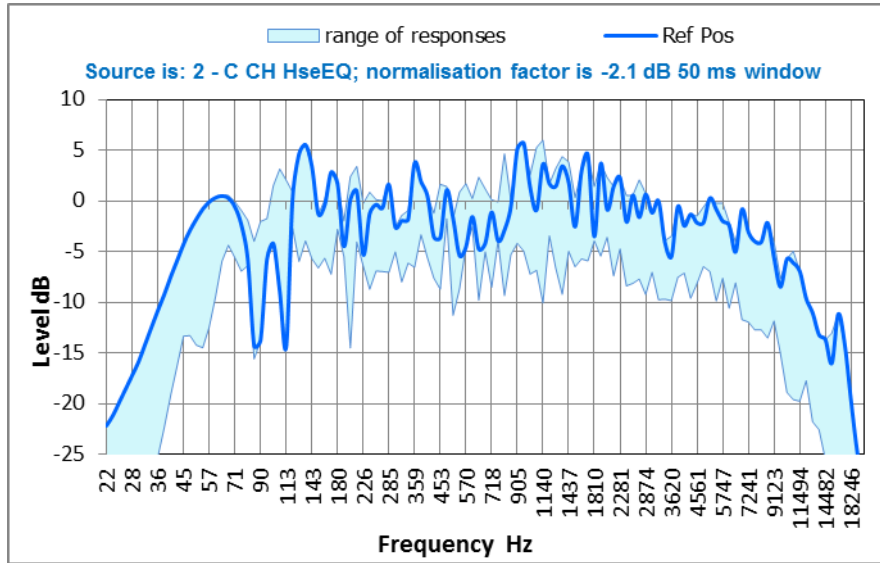

Figure D 1 Cinema D Comparison of mic positions and time windows for given source. Responses have been normalized'.

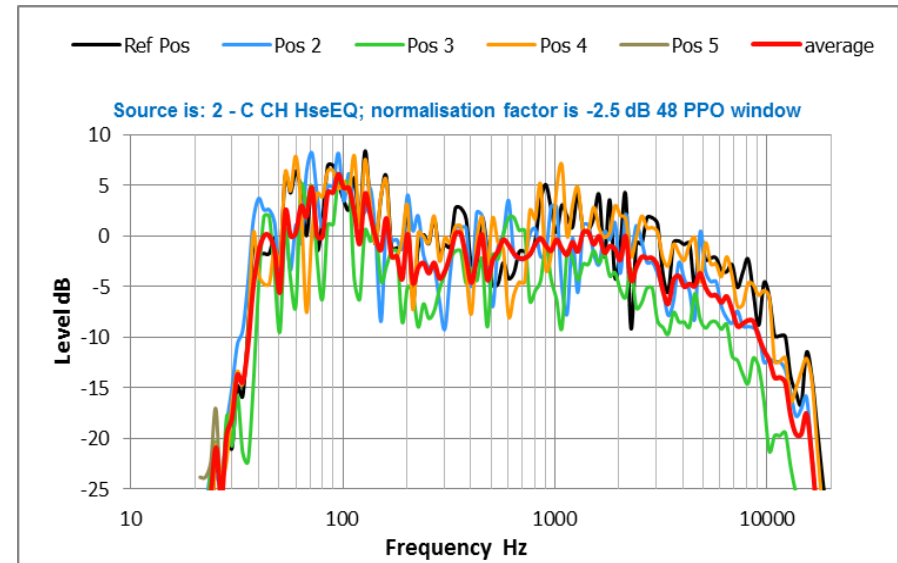
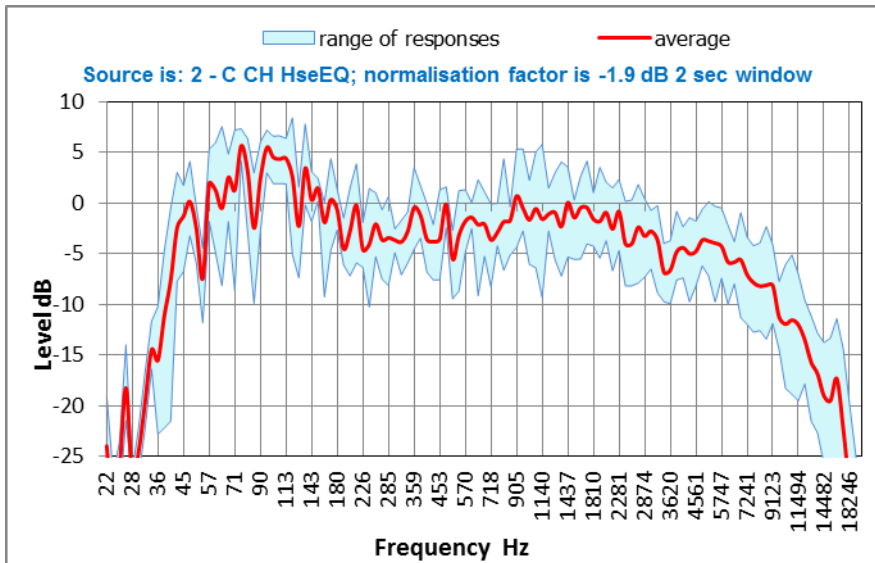
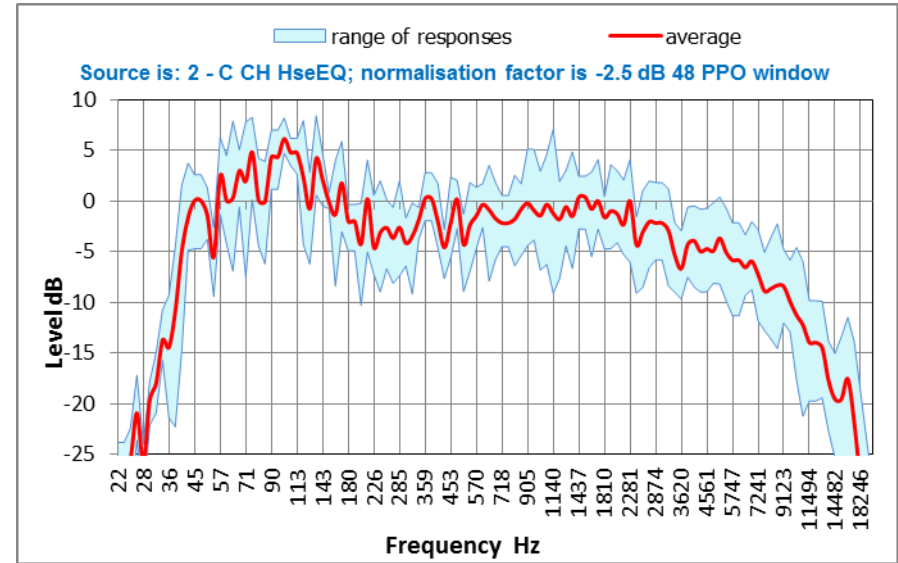
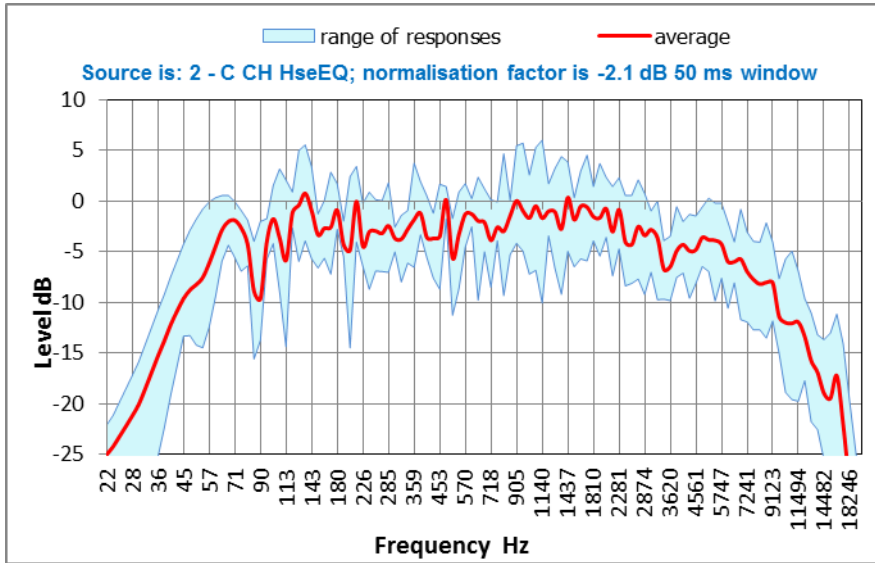

Figure D 2 Cinema D Comparison of the average (pressure), maximum and minimum responses and time windows for given source. Responses have been normalized.

Figure D 3 Cinema D Comparison of the average (pressure) and positional responses and time windows for 48 PPO. Responses have been normalized.

18.2 Comparison of Center Channel responses with different time windows at reference position

Figure D 6 compares the responses at the reference position of four time windows by referencing the response of each window to the 2 second response. .

Sections of the following responses are not shown due to the lack of resolution resulting from the time/frequency trade-off:

- 10 ms window below 150 Hz
- 50 ms window below 50 Hz

18.2.1 Discussion of Results

- From approximately 800 Hz up, the responses of the 10 ms, 50 ms and 2 second windows are remarkably similar. This indicates that the direct field strongly dominates the measurements, that reverberant build-up contributes only a small amount of sound to the total energy at these frequencies.
- The change in frequency response that is noted in (**Error! Reference source not found.**) due to the arrival of the reverberant field clearly does not occur here.
- The small differences between the 48 PPO and 10 ms and 2 s responses result from the shorter time window of the 48 PPO responses at these frequencies.
- As expected due to window length, the 10 ms window starts to differ from the 2 s reference around 700 Hz while for the 50 ms window this point is about 200 Hz.

18.3 Effect of equalization on Center Channel and X curve

Figure D 7 compares the equalized Center channel response at the reference position with the published X curve. To show the relative levels, the responses were not normalized.

18.3.1 Discussion of Results

- Compared to the X-curve, the response of Cinema D is rather uncharacteristic of the responses of the other cinemas between about 50 Hz and 1 kHz, shelving about 3 dB above the reference line up to 140 Hz and 3 dB below the line above 140 Hz.
- The high frequency response adheres to the X-curve quite closely between 1 kHz and 10 kHz, but then falls away sharply, except for a narrow peak about 16 kHz.

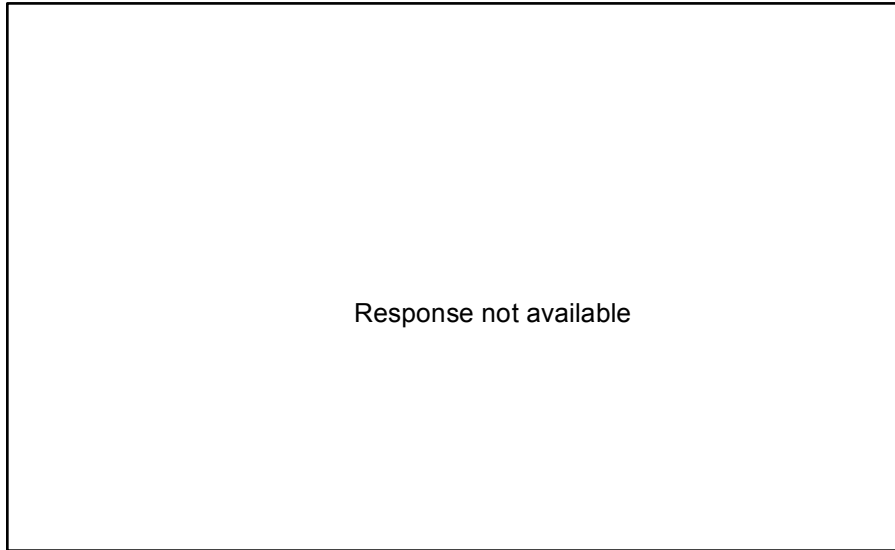

Figure D 4 Response not available

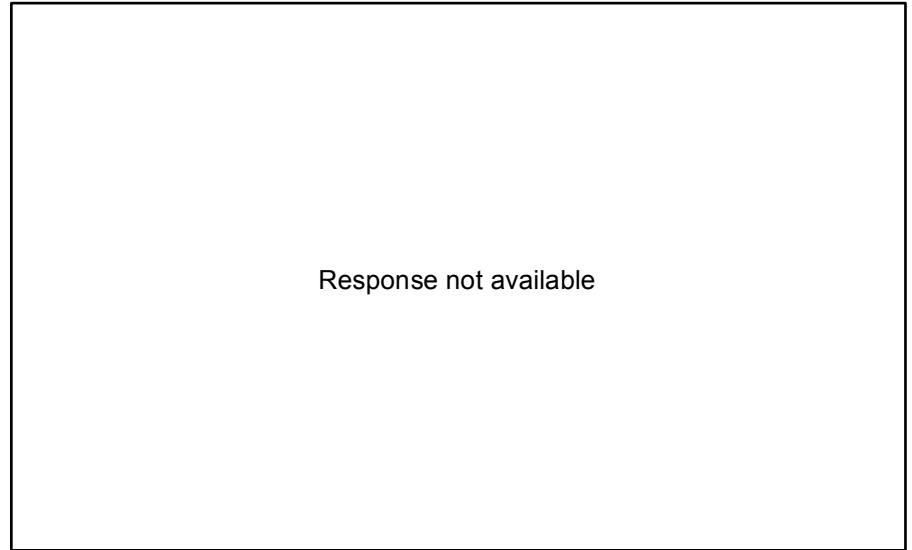

Figure D 5 Response not available.

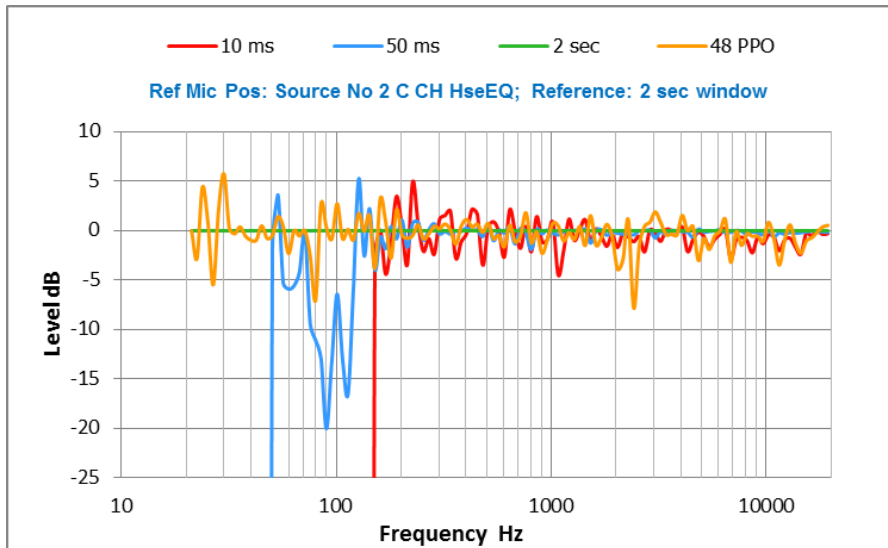

Figure D 6 Cinema D Responses with different windows at ref position Center Channel. NB 10 ms and 50 ms responses are truncated according to the time/frequency limit. normalized.

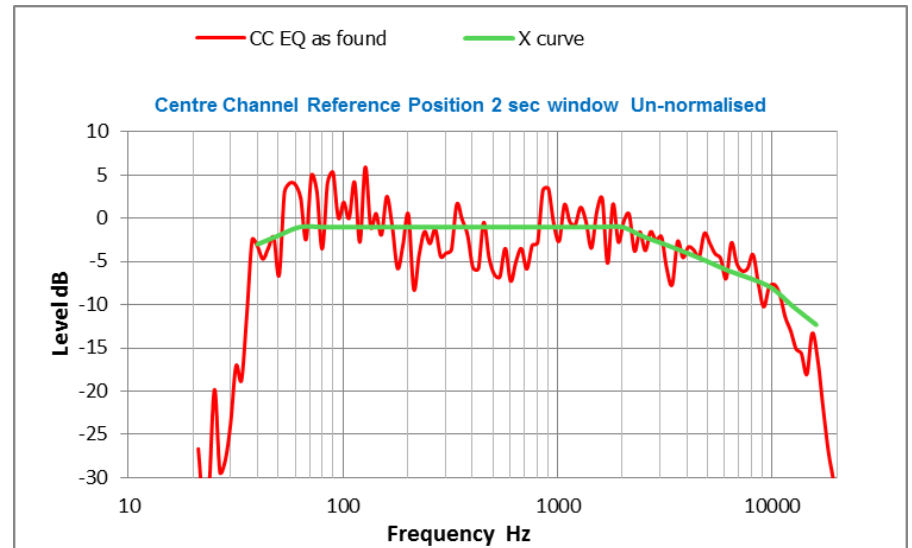

Figure D 7 Cinema D Comparison of responses of Centre Channel with equalization with X curve at reference position. Data is not normalized.

18.4 Comparison of front channels and time windows at Reference position

The responses of the left, center and right channels are shown for the three time windows.

- Figure D 8 A/B/C compare the responses at the reference position of the left, center and right channels.
- Figure D 8 D shows the overall range of responses of the three channels.
- Figure D 9 A/B/C compares the average response of the three channels.

18.4.1 Discussion of Results

- The low frequency responses of the left and right channels in the 40 to 60 Hz region are generally higher than those of the center channel, and would yield audible differences with the center channel. This boost would be typical of the effect that occurs when a loudspeaker is located acoustically close to a side-wall boundary. The boundary produces in an increase in its radiation impedance (“load”) from the standard half-space load of the baffle wall. If this is the case in Venue D, then the loudspeakers’ power response will show this boost and therefore it could be successfully removed with equalization.
- However, the symmetry of the left and right responses, below 200 Hz, is not as good as would be desirable.
- All three screen channels show a relatively wide notch in their response between 500 Hz and 800 Hz.
- The measured responses below 1 kHz are not as uniform as in Venues A, B, or C.
- Although not evident in the plot of Figure D 8 because of normalization, the overall level of the right channel at the reference location is approximately 4.5 dB lower than the left channel and 3 dB lower than the center channel. However, even with normalization, the average level of the right channel is some 3 dB higher than the left and center averages.
- At least in terms of the measurements, the responses of the screen channels seem to be less than ideal. However, it is not known if this idiosyncratic equalization was done on a subjective basis, or not.

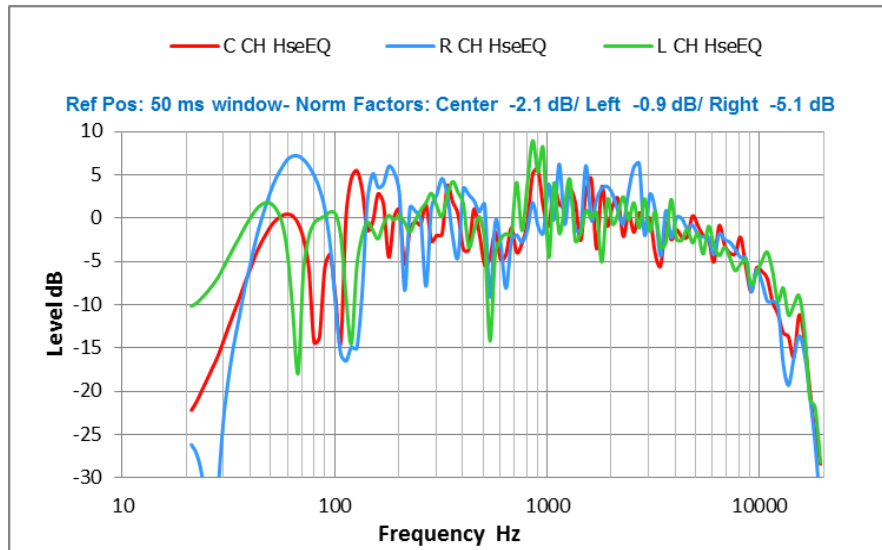

A 50 ms window.

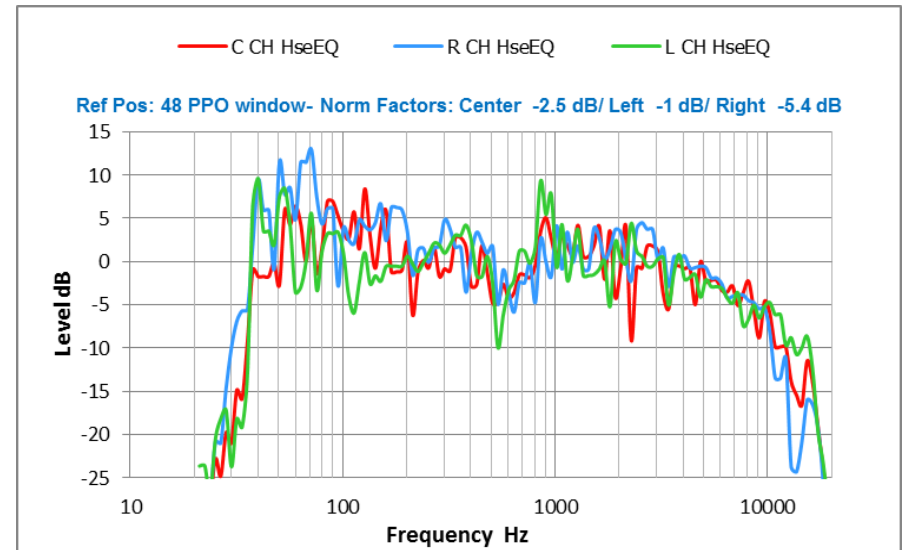

B 48 PPO window.

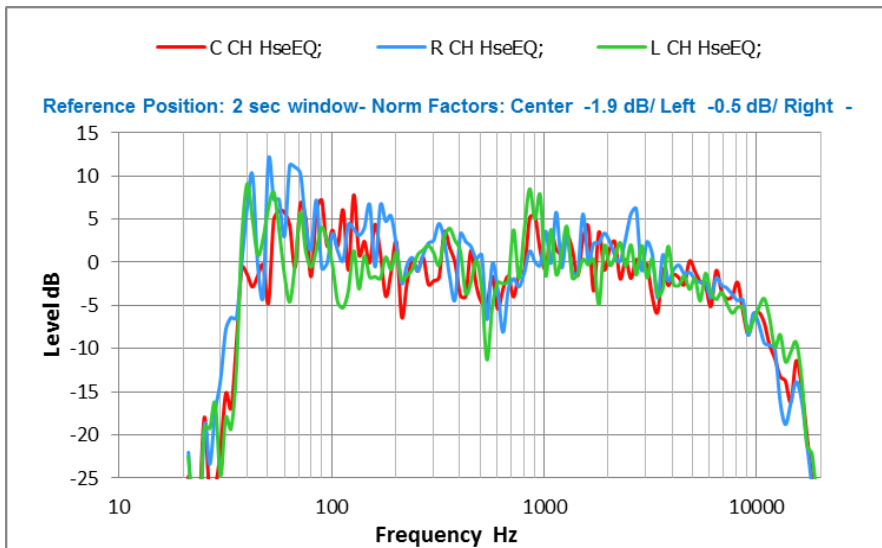

C 2 second window .

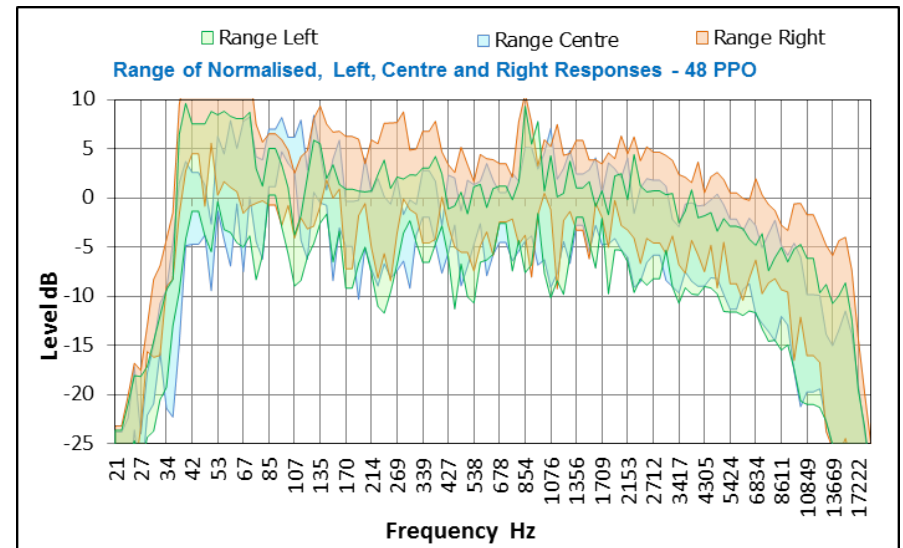

D 48 PPO window.

Figure D 8 A, B and C: Cinema D Comparison of L,C,R responses with equalization at reference position with time windows as noted. Responses are normalized. D: Comparison of maximum and minimum extremes over listening positions.. Responses are normalized.

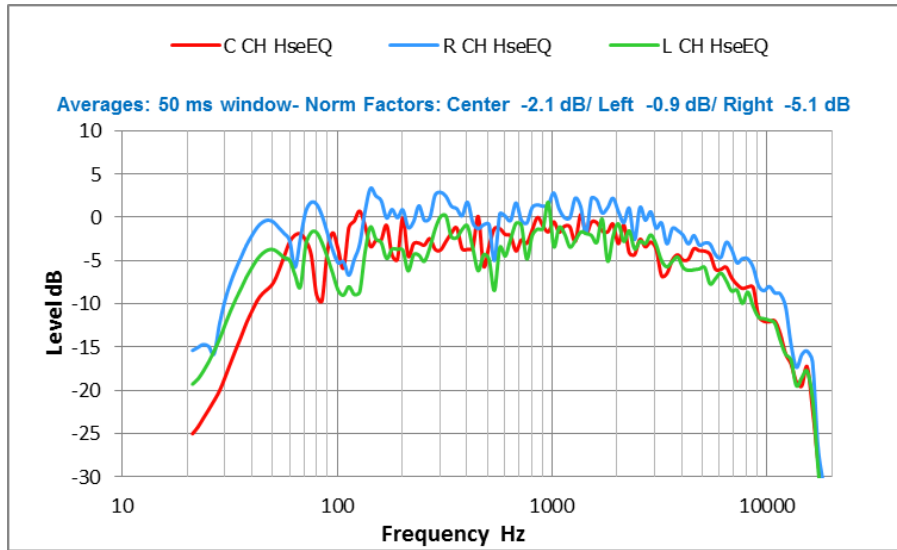

A 50 ms window

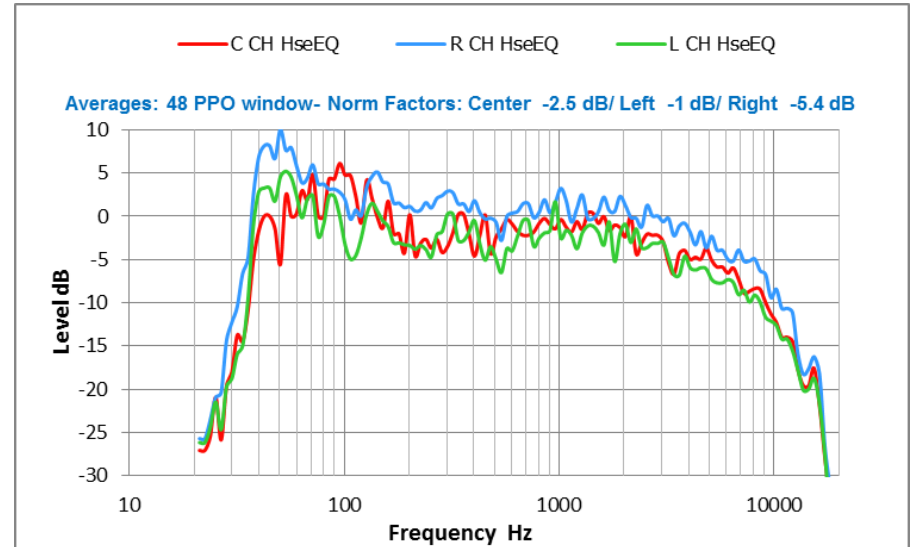

B 48 PPO window

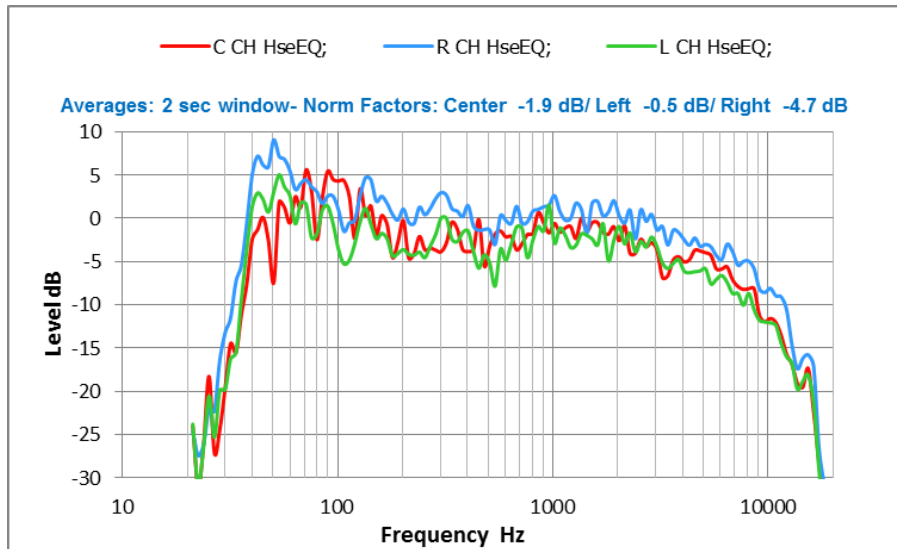

C 2 second window

Figure D 9 A, B and C: Cinema D Comparison of average L,C,R responses with equalization with time windows as noted. Responses are normalized prior to averaging.

18.5 LFE Channel

The following figures show responses for the LFE channel based on a 2 s window:

- Figure D 10 compares the reference response with the range of responses over the microphone positions.
- Figure C 11 shows the average response over the listening area and the range of responses over the microphone positions.
- Figure D 12 compares the responses at the five microphone positions.

All responses have been normalized to the average level of the Ref position over the range 40 Hz to 100 Hz.

Note that the response without equalization was not measured in all venues.

18.5.1 Discussion of Results

- The average LFE response is very smooth between about 25 and 100 Hz.
- The response at the reference position shows an average depression of some 3 dB around 70 Hz.
- The average low frequency response extends easily to 25 Hz, but the high frequency roll off begins rather early, commencing a roll off at 70 Hz and falling significantly above 90 Hz.
- As it is evident at all positions, the upper roll-off could be due to limitations in the loudspeaker response, or simply due to equalization.

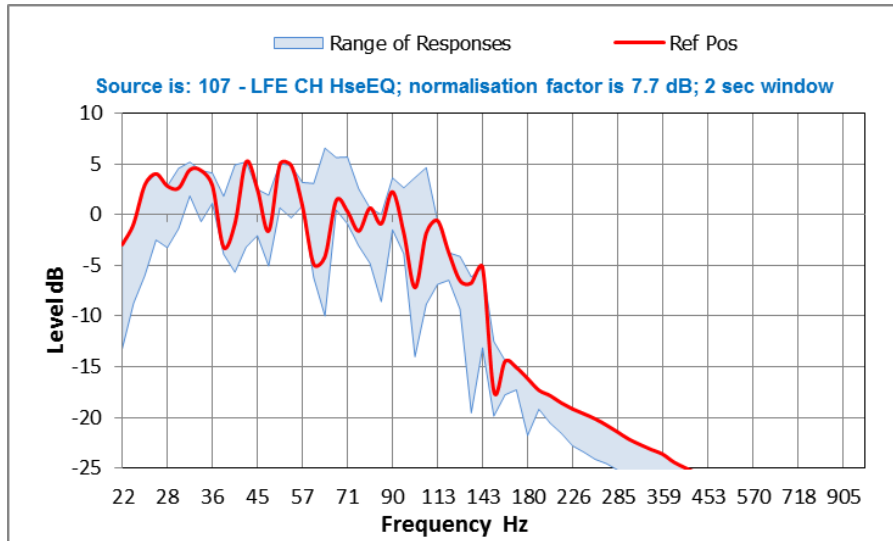

Figure D 10 Cinema D Comparison of extremes in responses over listening area for LFE channel with 2 sec window with equalisation. Responses normalized.

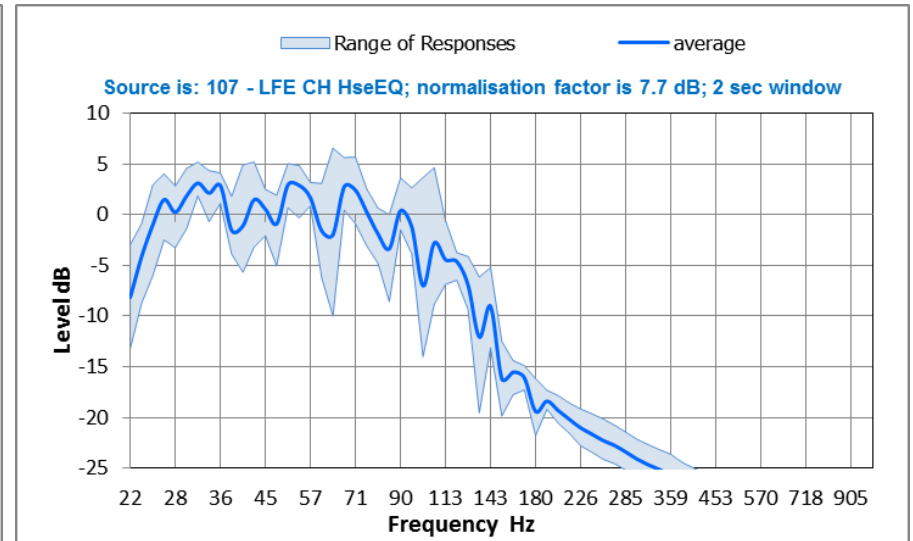

Figure D 11 Cinema D Comparison of average LFE responses with eq with 2 sec window. Responses normalized.

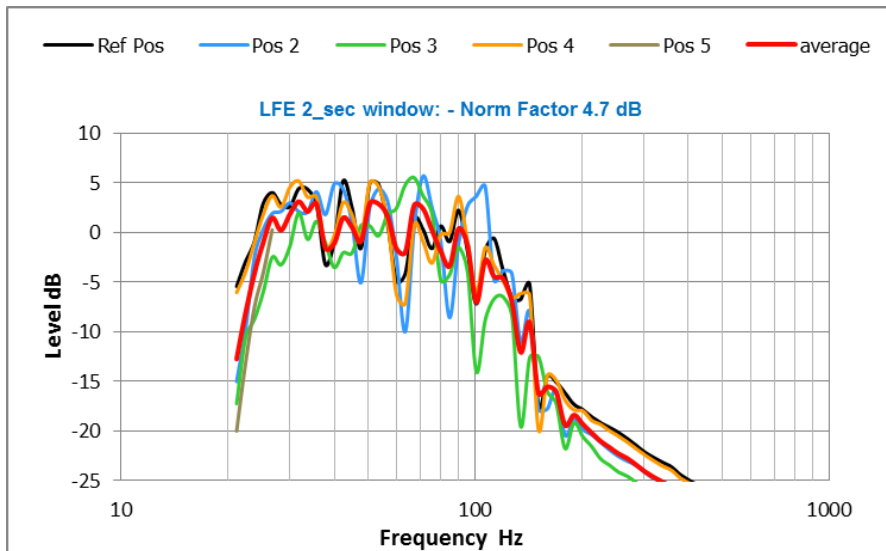

Figure D 12 Cinema D Comparison of individual responses in listening area for LFE channel with 2 sec window. Responses normalized..

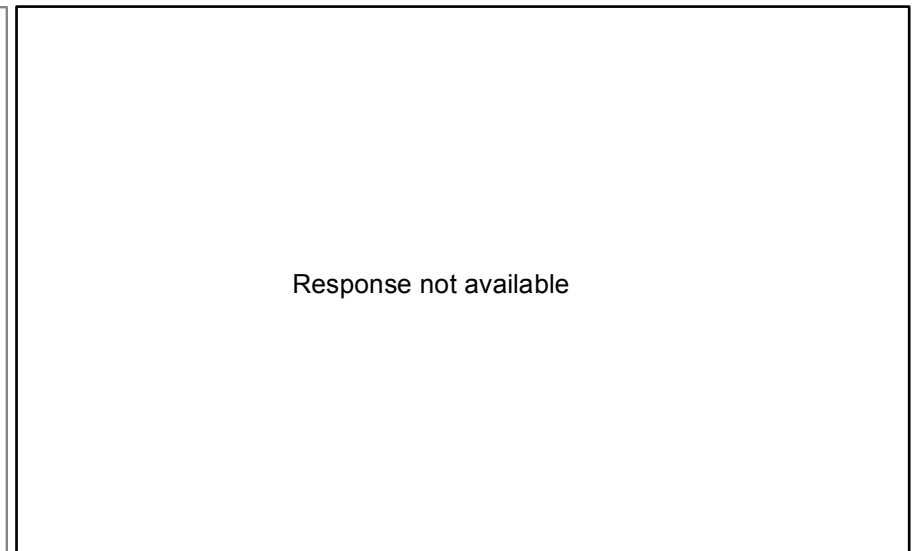

Figure D 13 Response not available

18.6 Surround channels

The following figures show responses for the Surround channels with equalization based on a 48 PPO window:

- Figure D 14 compares the responses at the reference position of the left side, right side, left rear and right rear surround channels.
- Figure D 15 compares the average responses of the above four channels.
- Figure D 16 compares the responses at each position with the average for the left side surround channel.
- Figure D 17 compares the responses at each position with the average for the right side surround channel.
- Figure D 18 compares the responses at each position with the average for the left rear surround channel.
- Figure D 19 compares the responses at each position with the average for the right rear side surround channel.

All responses were normalized to the average level of the Reference position response.

18.6.1 Discussion of Results

- The responses of the surround loudspeaker arrays in this room are rather uneven.
- They all exhibit a standard X-curve roll off to some extent.
- A response peak of around 5 dB between 50 Hz and 60 Hz is evident in most responses.
- It is interesting that the lower limit of the responses is about 50 Hz. In contrast, the lower limit of Cinema A is 40 Hz; in Cinema B it is 30 Hz; and in Cinema C it is 60 Hz. In these four commercial venues there is therefore a full octave of variation in the LF extension of the surround channels.

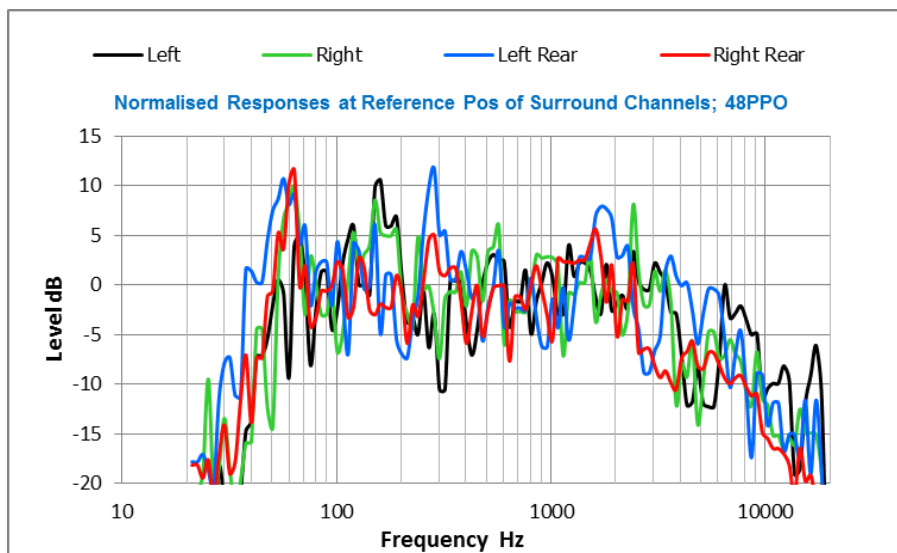

Figure D 14 Cinema D Comparison of responses at Reference Position for Surround channels with 48 PPO window. Responses normalized to average level of Ref position.

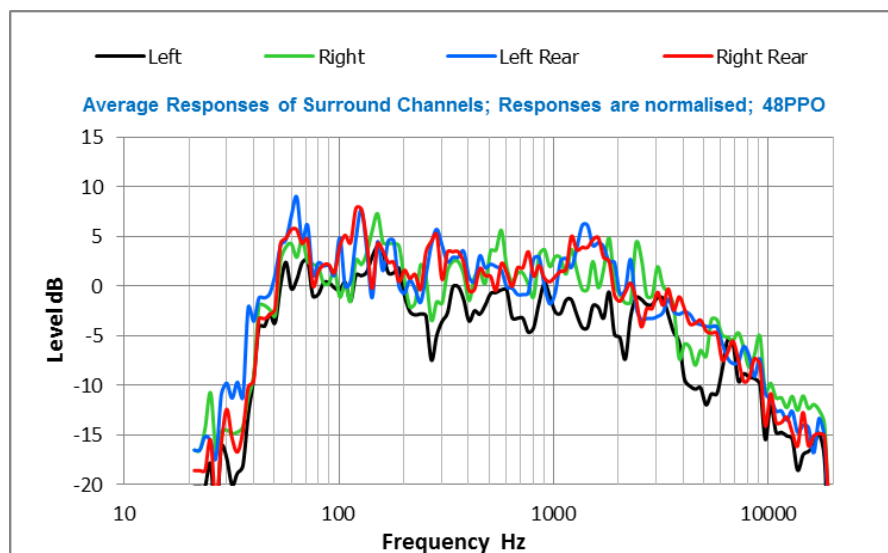

Figure D 15 Cinema D Comparison of average responses over listening area for Surround channels with 48 PPO window. Responses normalized to average level of Ref position.

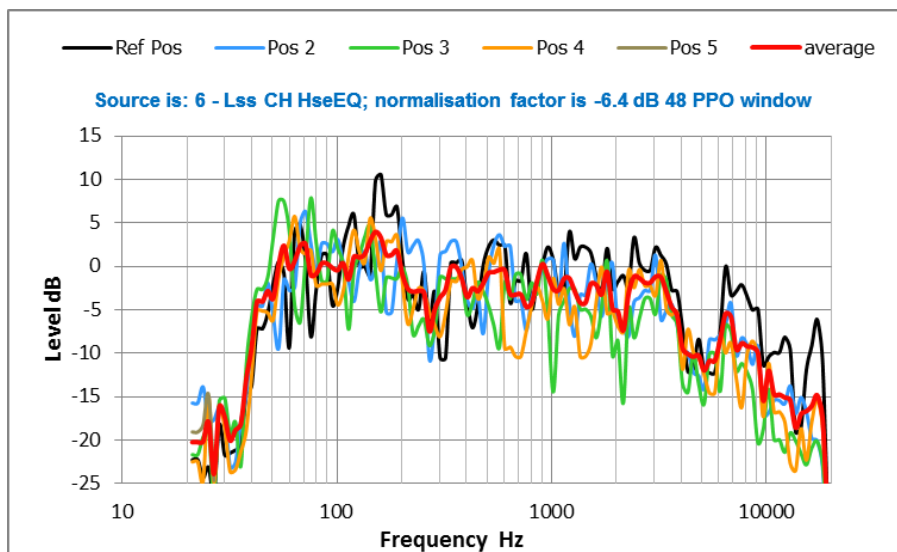

Figure D 16 Cinema D Comparison of responses in listening area for Left Side Surround channel with window. Responses normalized to average level of Ref position.

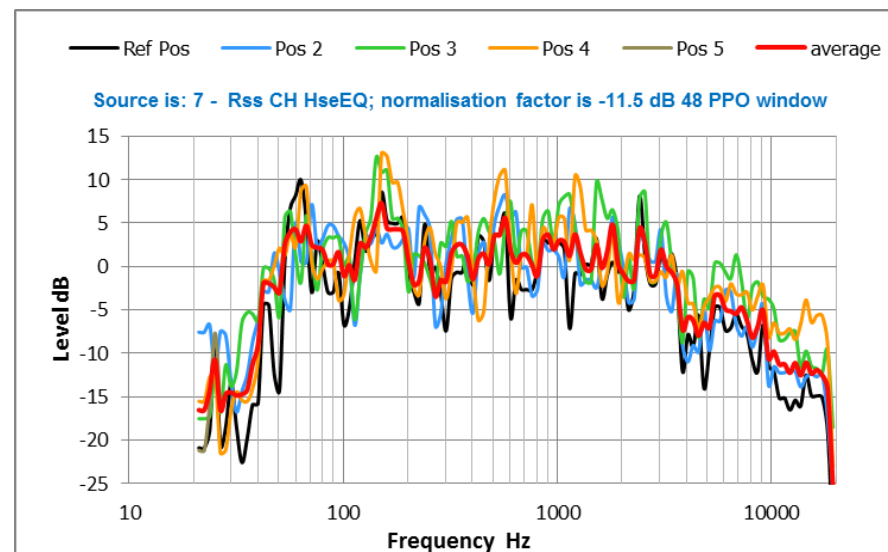

Figure D 17 Cinema D Comparison of responses in listening area for Right Side Surround channel with window. Responses normalized to average level of Ref position.

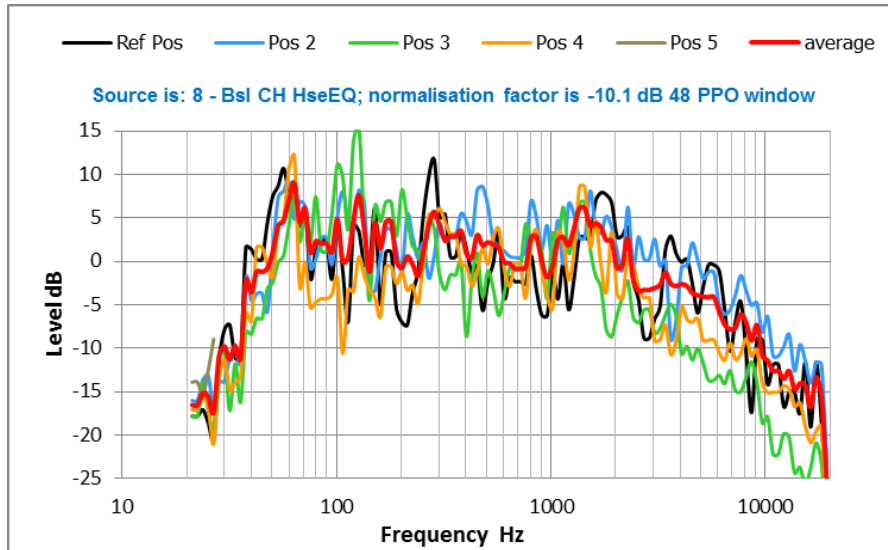

Figure D 18 Cinema D Comparison of responses in listening area for Left Rear Surround channel with window. Responses normalized to average level of Ref position.

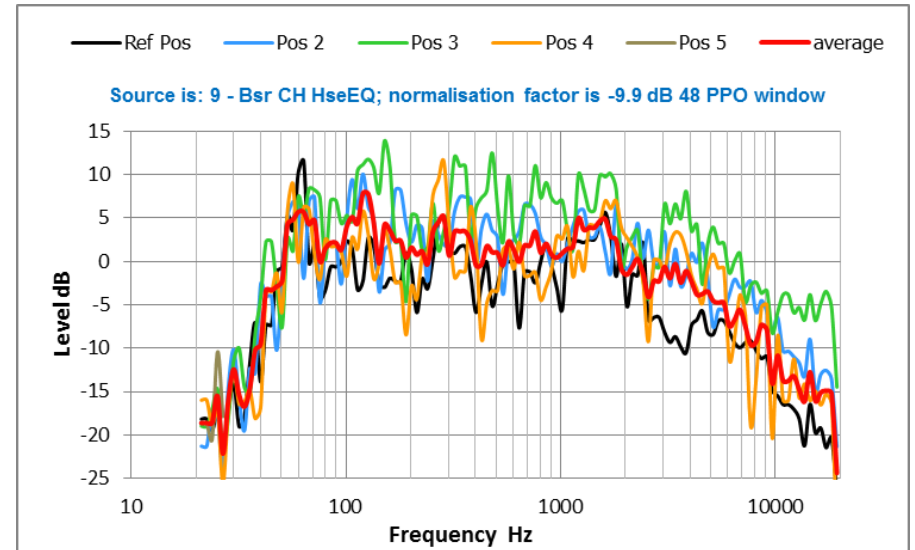

Figure D 19 Cinema D Comparison of responses in listening area for Right Rear Surround channel with window. Responses normalized to average level of Ref position.

18.7 Room Acoustic Measures

Temporal parameters that have been derived from the impulse response of the Centre Channel at the Reference position are shown in the following figures.

- Figure D 20 shows the impulse response filtered to the range of 500 Hz to 4 kHz
- Figure D 21 shows the Schroeder decay curve associated with the impulse response
- Figure D 22 shows the reverberation times computed from the Schroeder decay range of -20 dB to -40 dB.
- Figure D 23 shows the cumulative energy in octave bands.

18.7.1 Discussion of Results

- The decays shown in the impulse and Schroeder plots (500 Hz to 4 kHz) are commendably smooth.
- The reverberation times peak in the 125 Hz band, and falls significantly by the 63 Hz and 250 Hz bands.
- The RTs from 500 Hz to 8 kHz are commendably consistent.
- The RTs at 125 Hz and 250 Hz are rather high for modern cinema soundtracks.
- Section 18.5.1 noted that the LFE response rolled off considerably above 90 Hz. Perhaps this had been done deliberately to counteract the higher decay time in that region, bringing it more into line, perceptually, with the lower frequency band.
- The cumulative energy plots show rapid early development of the sound field from 250 Hz upward. However the buildup of low frequency energy is comparatively slow, suggesting that the bass sound will not have the desired impact. Given the shorter RT at 63 Hz compared to 125 Hz, it is surprising that the CE plot shows a substantially longer buildup at 63 Hz.

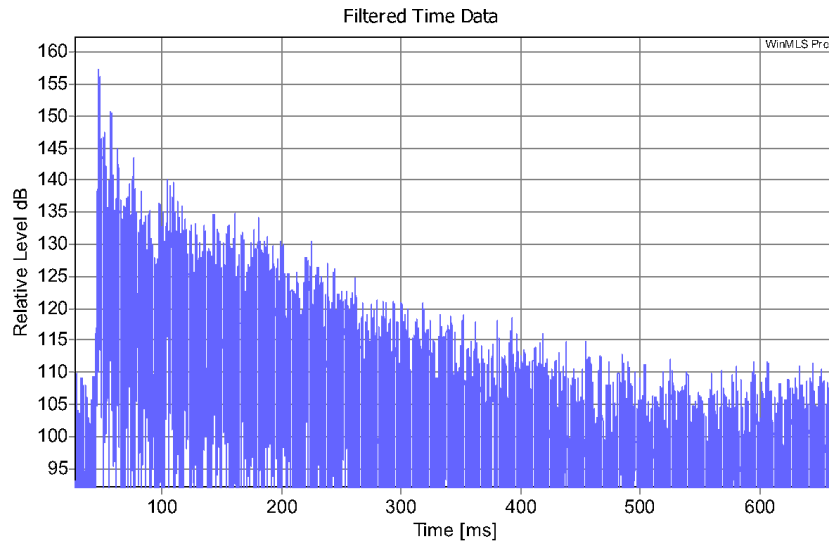

Figure D 20 Cinema D Impulse Response filtered 500 Hz to 4

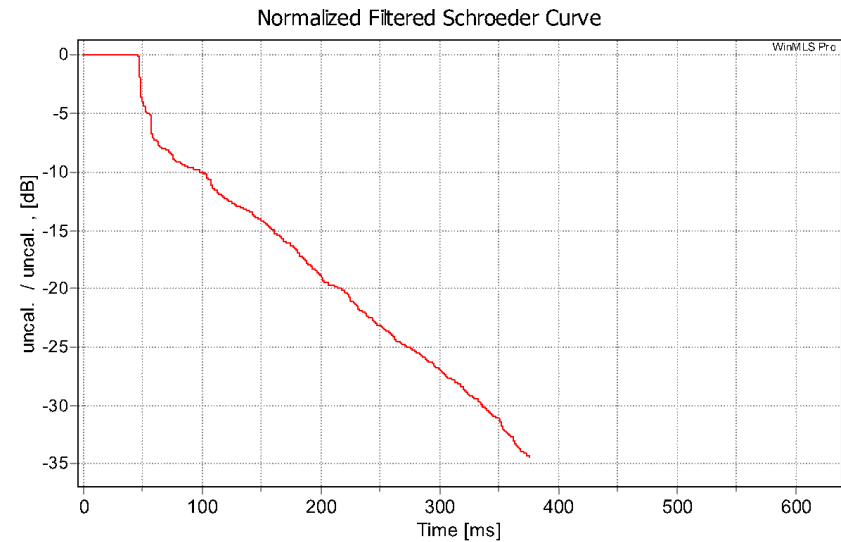

Figure D 21 Cinema D Schroeder decay plot filtered 500 Hz to 4 kHz

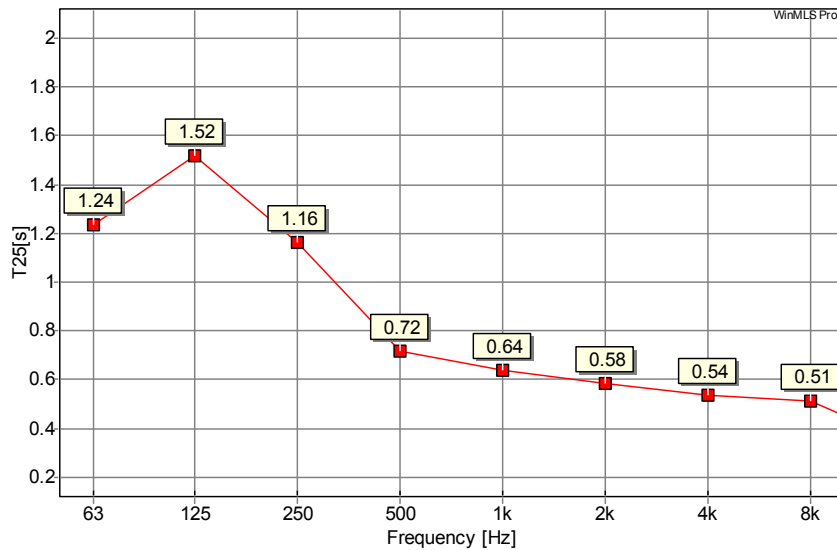

Figure D 22 Cinema D Reverberation times taken over decay range -15 dB to -25 dB

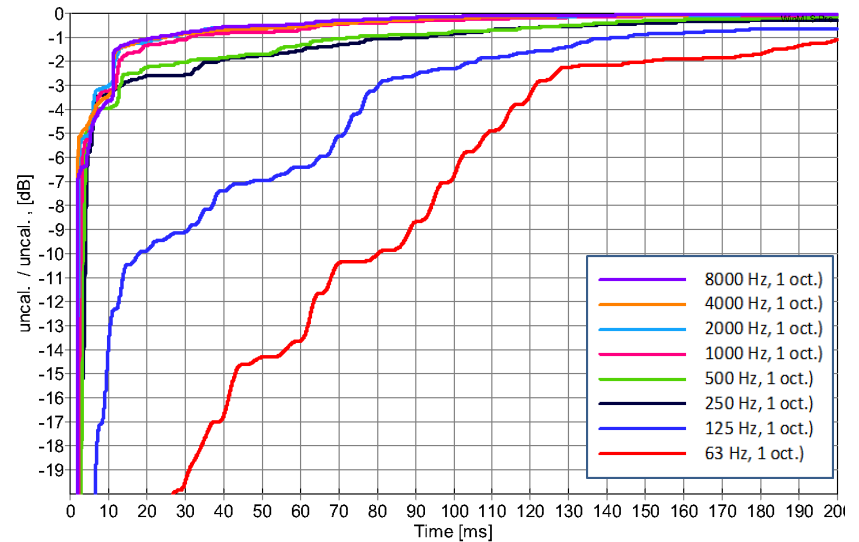

Figure D 23 Cinema D Cumulative energy in octave bands.

19 RESPONSES OF DUBBING STAGE E

19.1 Centre Channel

19.1.1 Audience positions

Figure E 1 shows the response at the reference position and the range of responses over all the listening positions with the three time windows. Figure E 2 shows the average response and the range of responses with the three time windows. Figure E 3 compares the average response with the individual position responses. Figure E 4 compares the responses of the tree microphones with the reference position, while Figure E 5 compares the average response with those of the tree microphones.

19.1.1.1 Discussion of Results

- The 50 ms response of both the average and the reference position show a significant dip centered at 190 Hz. This dip is partly filled in by the later arrivals, as seen in the 48 PPO and 2 sec responses. As the dip is present in the average response, it suggests that the overall power response of the system is lacking in this region.
- Above 300 Hz, the responses with all three time windows are very similar.
- Both the response at the reference position and the average response of the channel extend to 33 Hz, however the low frequency response is not flat, showing an overall energy boost between 45 Hz and 100 Hz compared to the mid-band level extending from 300 Hz to 1 kHz. The overall response is rather uneven in the region between 90 Hz and 300 Hz.
- The 100 Hz dip at the reference position is not evident at the other measurement positions. This dip is not untypical of cancellation due to a floor reflection.

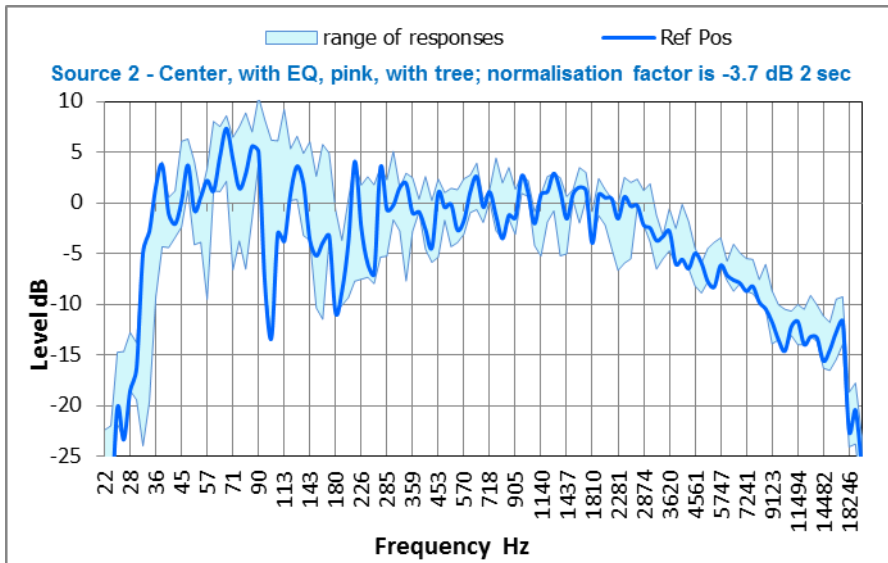
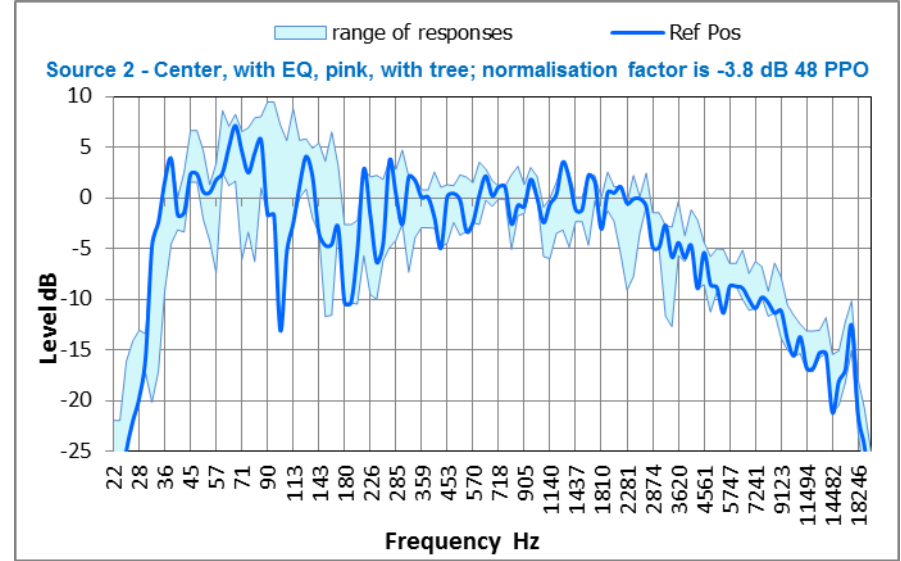
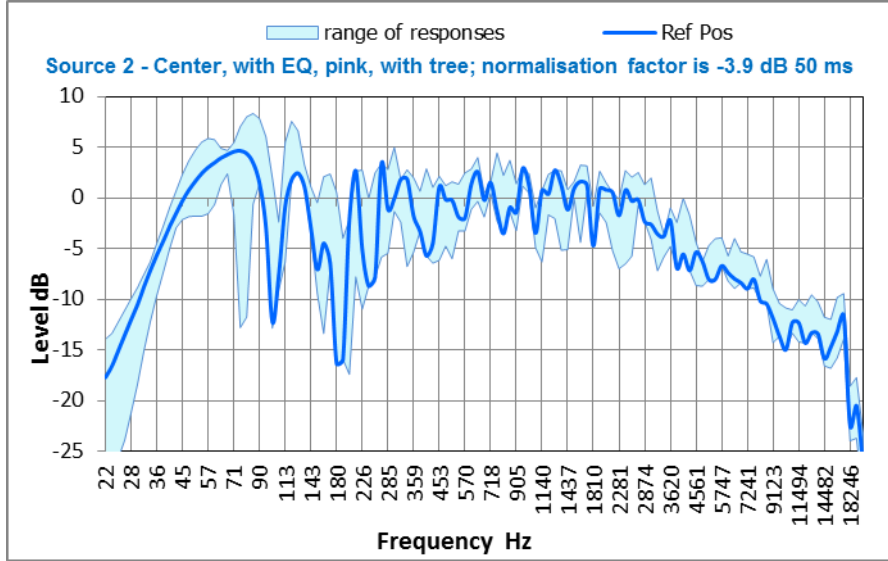

Figure E 1 Dubbing Stage E Comparison of mic positions and time windows for given source. Responses have been normalized'.

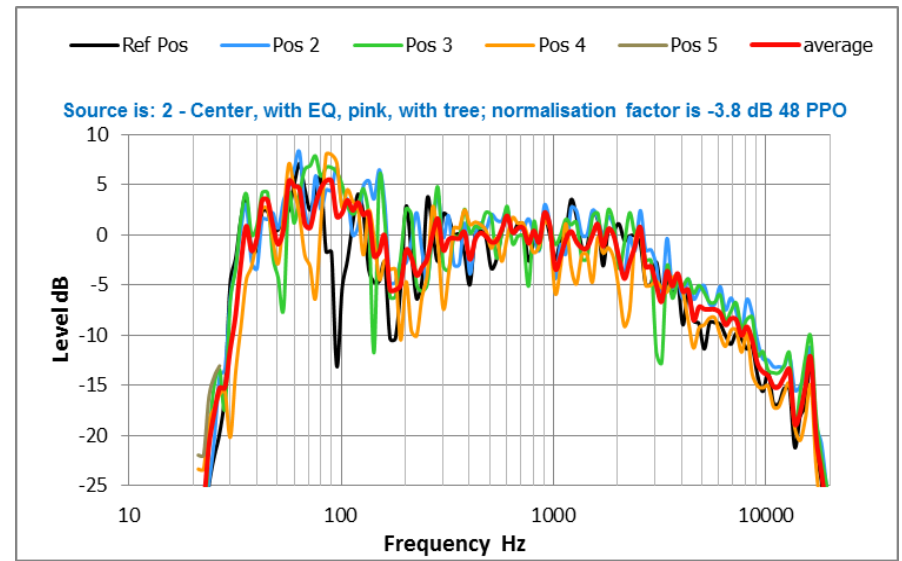
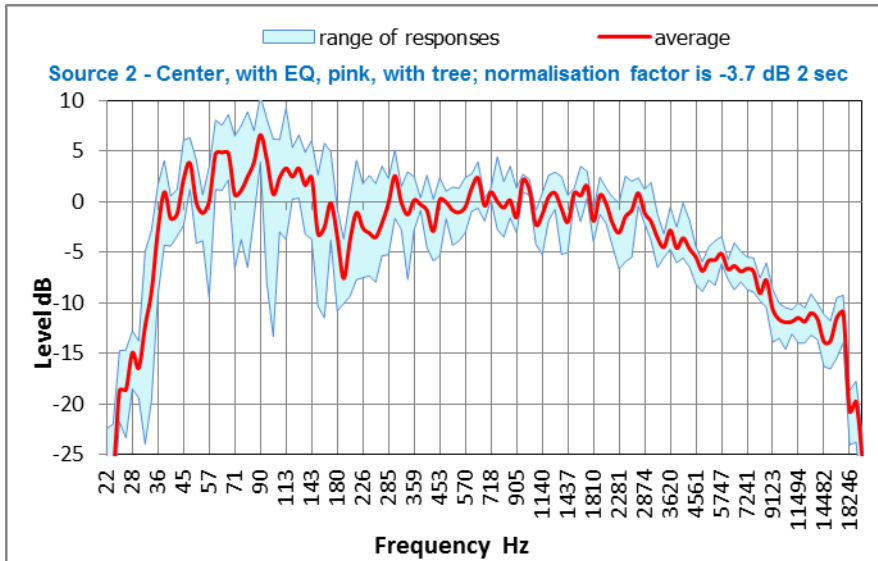
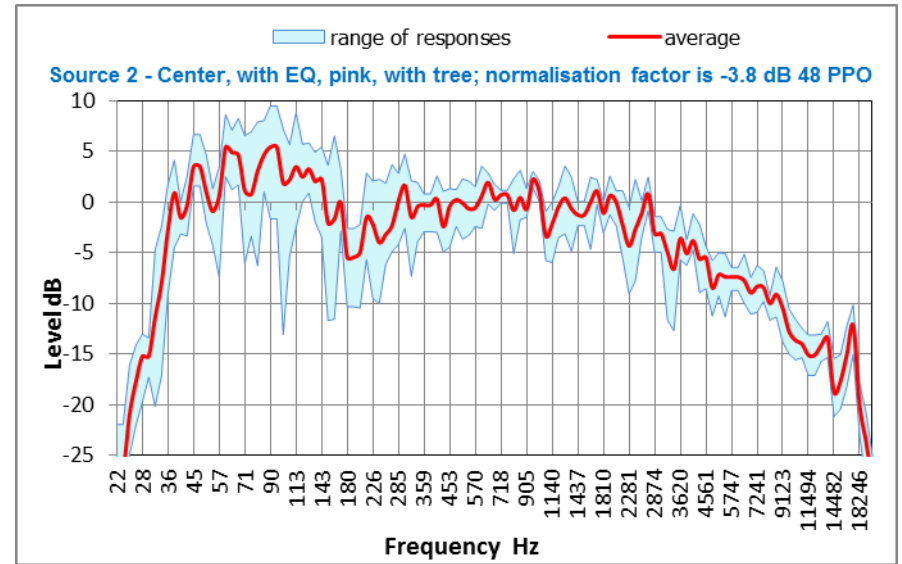
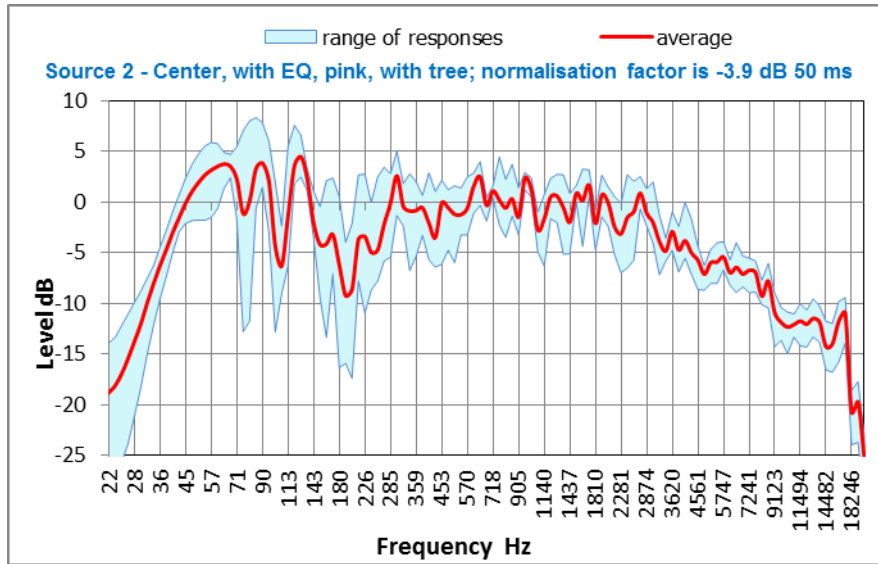

Figure E 2 Dubbing Stage E Comparison of the average (pressure), maximum and minimum responses and time windows for given source. Responses have been normalized.

Figure E 3 Dubbing Stage E Comparison of the average (pressure) and positional responses and time windows for 48 PPO. Responses have been normalized.

19.2 Comparison of close-field (tree) and listening-area microphone positions for Center Channel

Figure E 4 compares the measured response at the reference position with the responses at the tree microphones. Figure E 5 compares the average listening position response with the response at the tree microphone. The time window used is 48 PPO.

19.2.1 Discussion of Results

- The tree responses show a much lower level of LF response close to the loudspeakers, as compared to the reference position. The reason for this is not clear, especially given the low RTs and the rapid buildup of sound shown in the cumulative energy plots at low frequencies.
- The response of tree position A shows dips that relate to the measurements of crossover behavior at positions that are not equidistant to each driver in the system.
- The response of positions B and C exhibit reasonable similarity with the reference and average responses, although there are notable differences at high frequencies that cannot directly be explained.
- The roughness of the response between 100 and 300 Hz in the far-field responses of Figure E 2 are also evident in the tree responses as is a rolling off response above 3 kHz.

As the response of tree microphone A does not correspond with either B or C or the average response above 100 Hz, it would indicate that its position was not optimum.

19.3 Comparison of Center Channel responses with different time windows at reference position

Figure E 6 compares the responses at the reference position of four time windows by referencing the response of each window to the 2 second response.

Sections of the following responses are not shown due to the lack of resolution resulting from the time/frequency trade-off:

- 10 ms window below 150 Hz
- 50 ms window below 50 Hz

19.3.1 Discussion of Results

- From 500 Hz up, the responses of the 10 ms, 50 ms and 2 second windows are quite similar. This indicates that the direct field strongly dominates the measurements, and that reverberant build-up contributes only a small amount of sound to the total energy at these frequencies.
- The change in frequency response that is noted in (**Error! Reference source not found.**) due to the arrival of the reverberant field clearly does not occur here.
- The small differences between the 48 PPO and 10 ms and 2 s responses result from the shorter time window of the 48 PPO responses at these frequencies.
- As expected due to window length, the 10 ms window starts to differ from the 2 s reference around 400 Hz while for the 50 ms window this point is about 100 Hz.
- There are minor differences of the 48 PPO and 10 ms responses from the 50 ms second reference response above 3 kHz. Above 10 kHz, the short time windows of 10 ms and 48 PPO show up to 2 dB less energy than the 50 ms window, indicating that sound arriving between 10 ms and 50 ms is a key contributor to the response. This venue shows slightly greater differences between the time windows than other venues.



19.4 Effect of equalization on Center Channel and X curve

Figure E 7 shows the effect of equalization on the Center channel response at the reference position, along with the published X curve. To show the relative levels, the responses were not normalized.

19.4.1 Discussion of Results

- The unequalized HF roll-off of the loudspeaker and screen combination exhibits quite severe attenuation. This is particularly marked above 6 kHz. Equalization has been applied to reduce this attenuation, but the final response is still short of the 'normal' X-curve response by as much as 5 dB at 10 kHz.
- There is evidence of equalization in the regions of 40 Hz, 80 Hz and 300 Hz to 400 Hz. Without this equalization, the close-field responses shown in Figure E 5 would be worse.

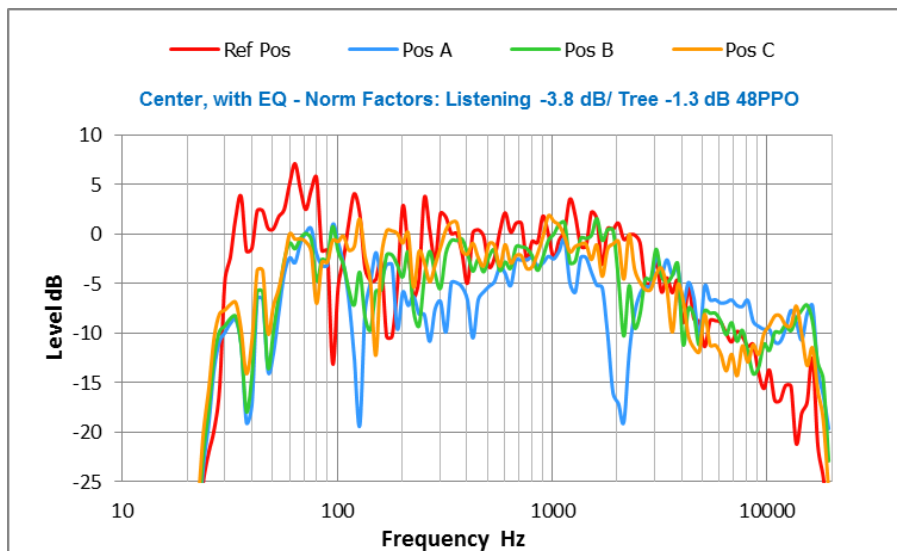

Figure E 4 Dubbing Stage E Comparison of responses at Tree Mics with response at reference microphone for Center Ch and 48 PPO window. Tree responses are normalized to Pos B.

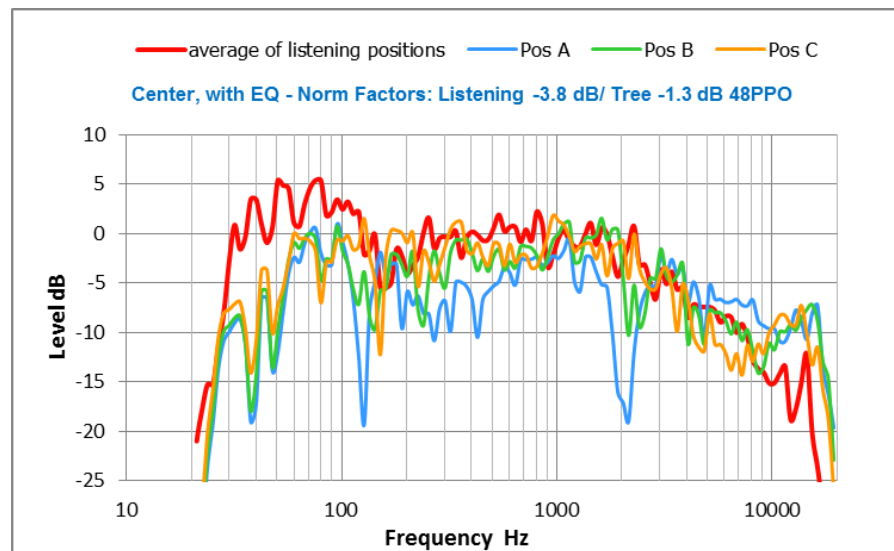

Figure E 5 Dubbing Stage E Comparison of average listening response with tree position microphones for Center Ch and 48 PPO window. Tree responses are normalized to Pos B.

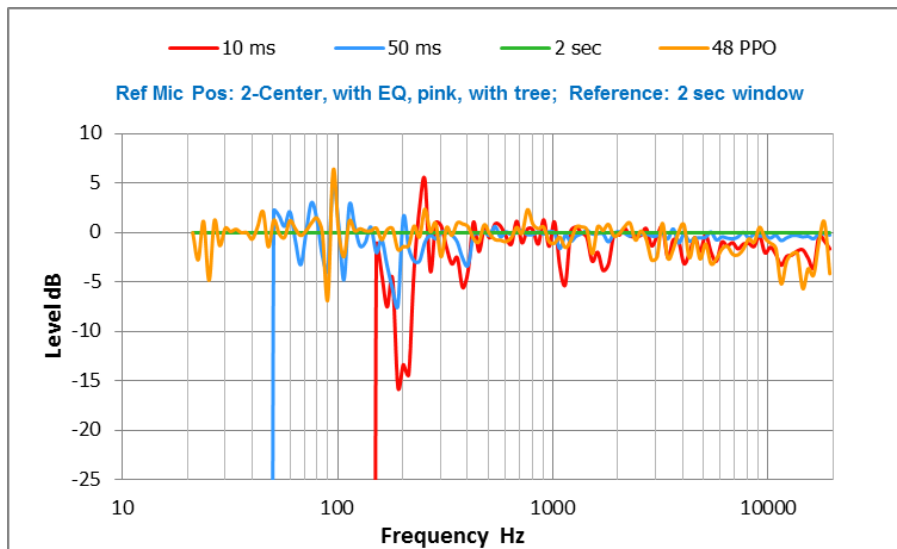

Figure E 6 Dubbing Stage E Responses with different windows at ref position Center Channel. NB 10 ms and 50 ms responses are truncated according to the time/frequency limit. normalized.

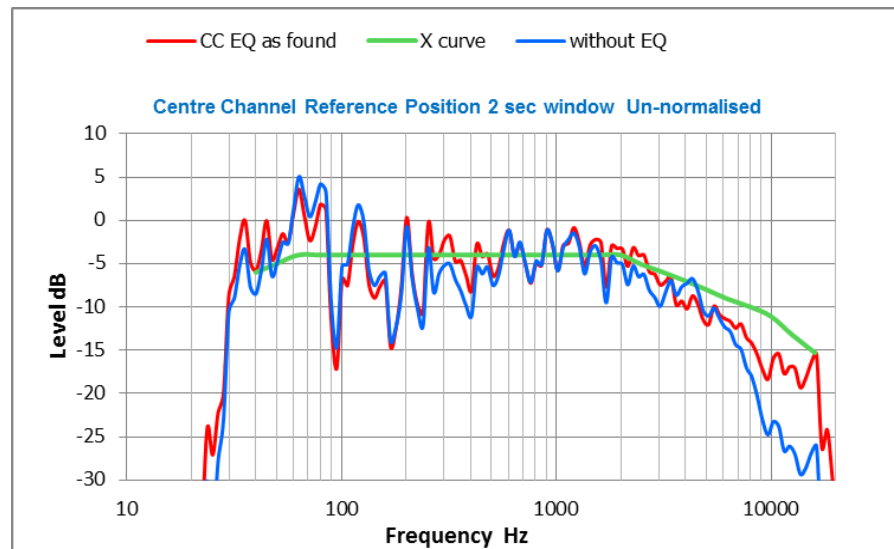

Figure E 7 Dubbing Stage E Comparison of responses of Centre Channel with & without equalization with X curve at reference position. Data is not normalized.



19.5 Comparison of front channels and time windows at Reference position

The responses of the left, center and right channels are compared at the reference position with three time windows.

- Figure E 8 A/B/C compare the responses at the reference position of the left, center and right channels.
- Figure E 8 D shows the overall range of responses of the three channels.
- Figure E 9 A/B/C compares the average response of the three channels.

19.5.1 Discussion of Results

- The response at the reference position shows response peaks for all three loudspeakers between 60 and 90 Hz. In the average response, the severity of these peaks is reduced.
- There is poor consistency of the responses below 300 Hz of three screen channels at the reference position. This inconsistency is not seen in the average responses, which show considerable similarity.
- The average responses of the three channels all exhibit a definite notch centered at 200 Hz. Given that it is in all three averages, it is likely to be related to an anomaly in the design or set-up of each loudspeaker.

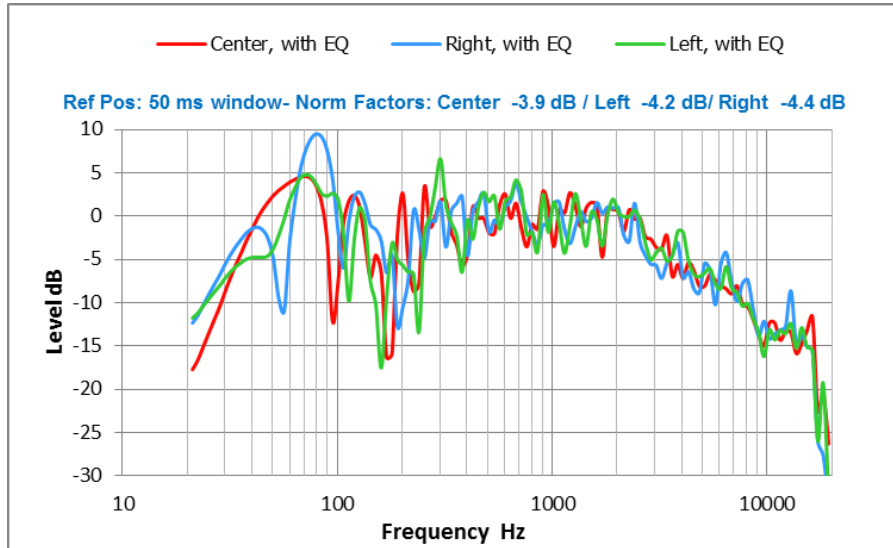

A 50 ms window.

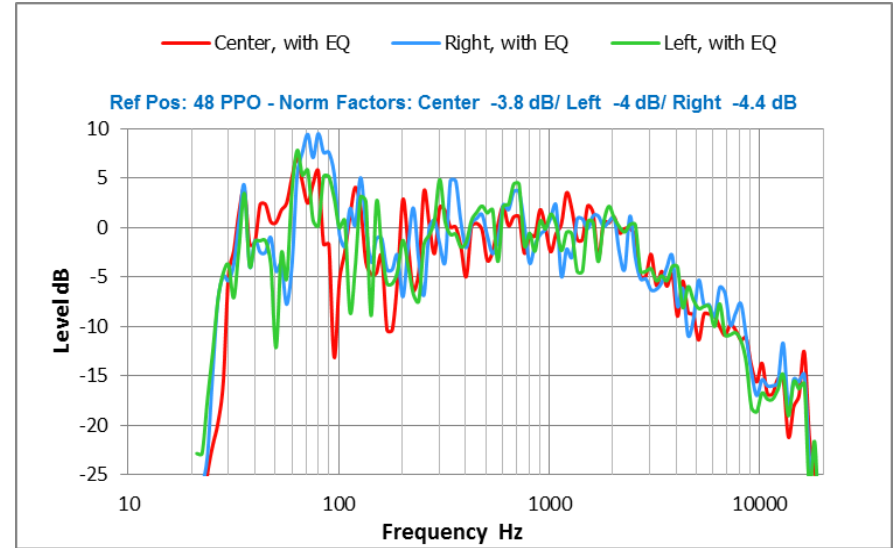

B 48 PPO window.

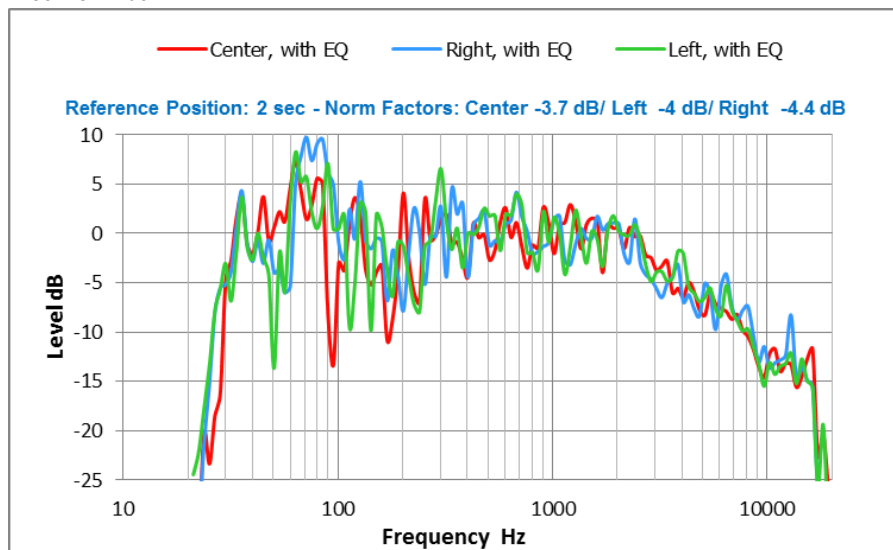

C 2 second window .

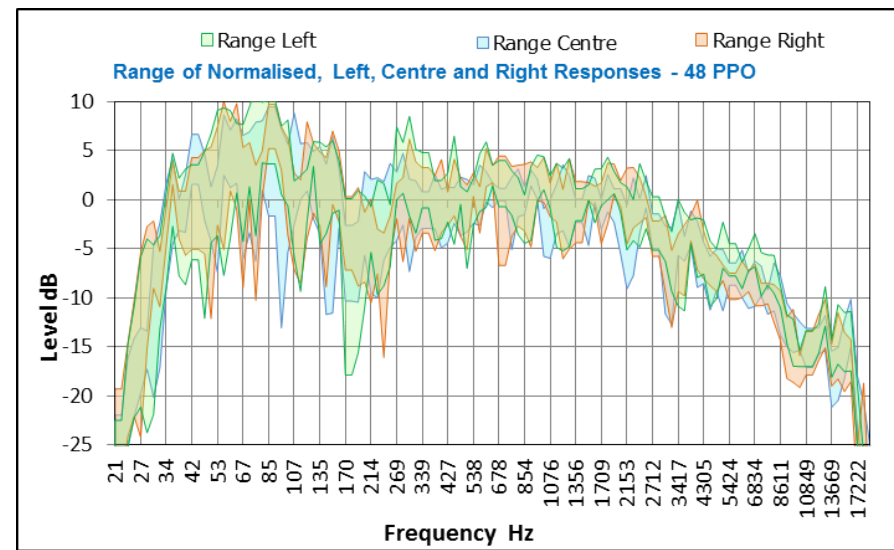

D 48 PPO window.

Figure E 8 A, B and C: Dubbing Stage E Comparison of L,C,R responses with equalization at reference position with time windows as noted. Responses are normalized. D: Comparison of maximum and minimum extremes over listening positions.. Responses are normalized.

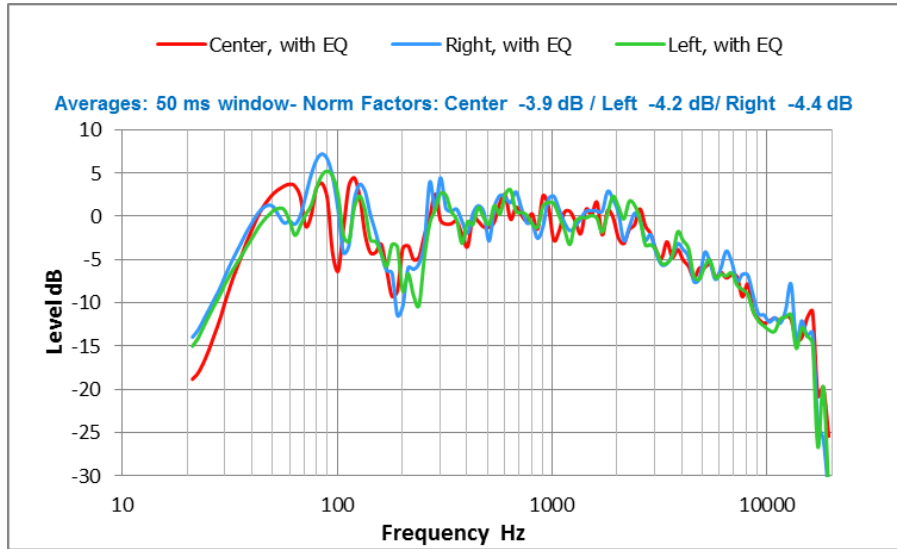

A 50 ms window

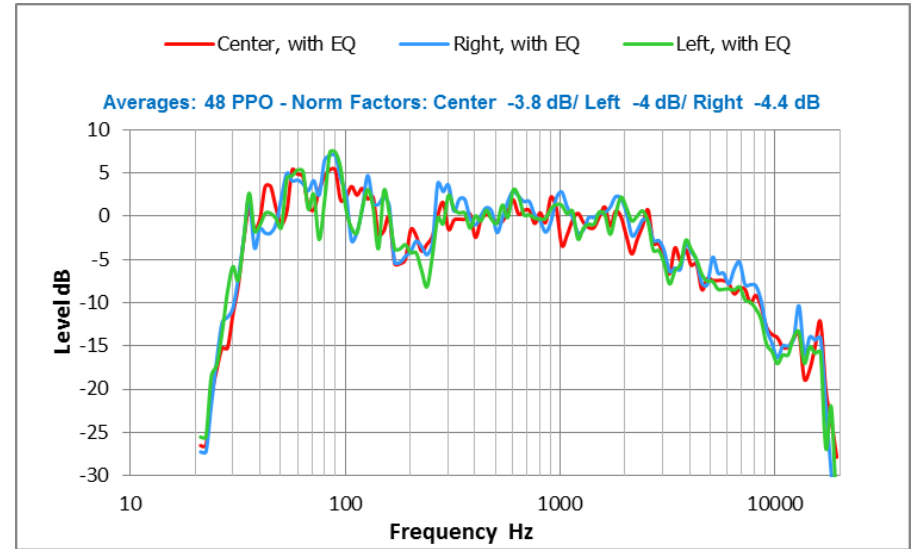

B 48 PPO window

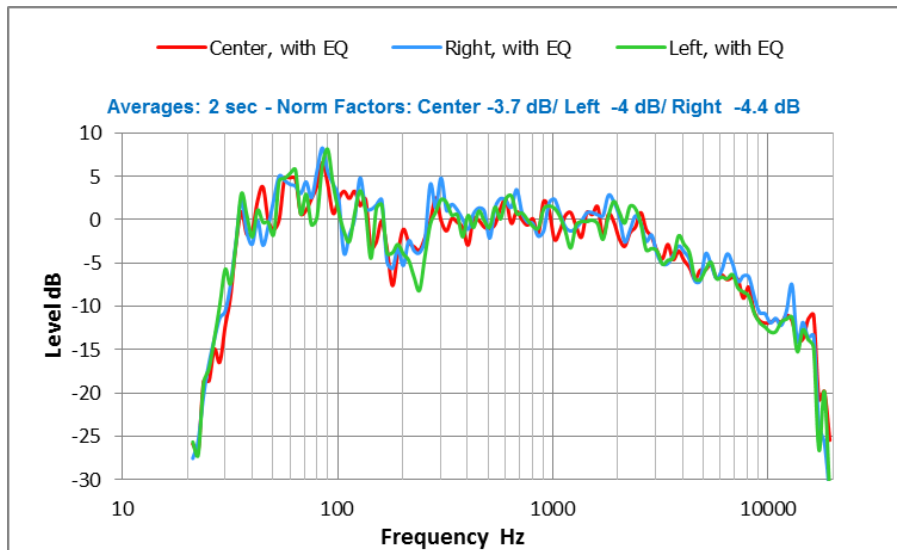

C 2 second window

Figure E 9 A, B, C Dubbing Stage E Comparison of average L,C,R responses with equalization with time windows as noted. Responses are normalized prior to averaging.



19.6 LFE Channel

The following figures show responses for the LFE channel based on a 2 s window:

- Figure E 10 compares the response at the reference position with the range of responses over the microphone positions.
- Figure E 11 shows the average response over the listening area and the range of responses over the microphone positions.
- Figure E 12 compares the responses at the five microphone positions.

In the above figures, the responses have been normalized to the average level of the Reference position over the range 40 Hz to 100 Hz.

Figure E 13 compares the average response over the listening area with and without the as-found equalization. To allow assessment of the effect of equalization on the overall level of the LFE channel, normalization was not applied to these responses.

19.6.1 Discussion of Results

- The LFE responses are perhaps the worst of the venues tested in this report.
- There is a pronounced bump in the response between 40 and 60 Hz, and the positional uniformity is not very good. The average response rolls off at approximately 40 Hz, which is comparatively high, although there is useful output at 20 Hz, about 15 dB down relative to the 40 Hz to 60 Hz level.
- Low-pass filtering appears to be applied above approximately 120 Hz that is Shas per the RP 200 requirement.
- The identical equalized and unequalized responses indicate that either equalization was not applied to the LFE channel, or there was a labeling error on site.

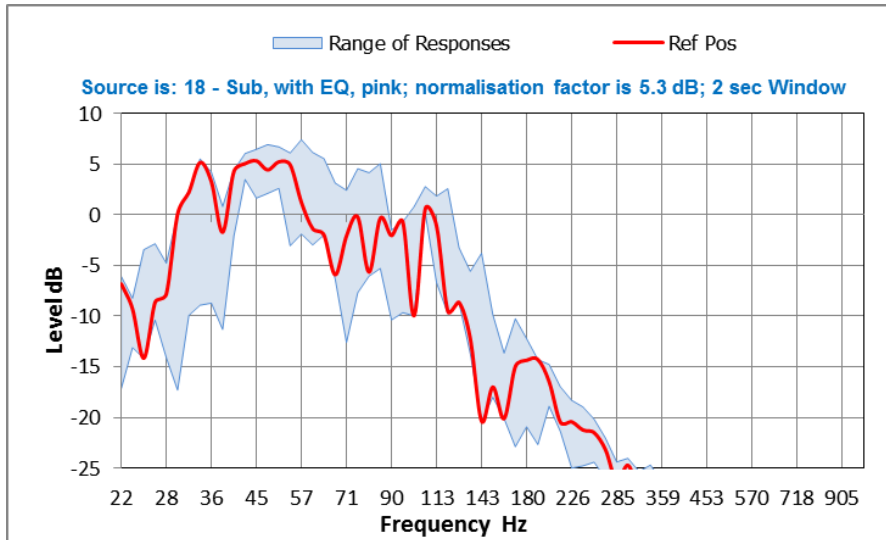

Figure E 10 Dubbing Stage E Comparison of extremes in responses over listening area for LFE channel with 2 sec window with equalization. Responses normalized.

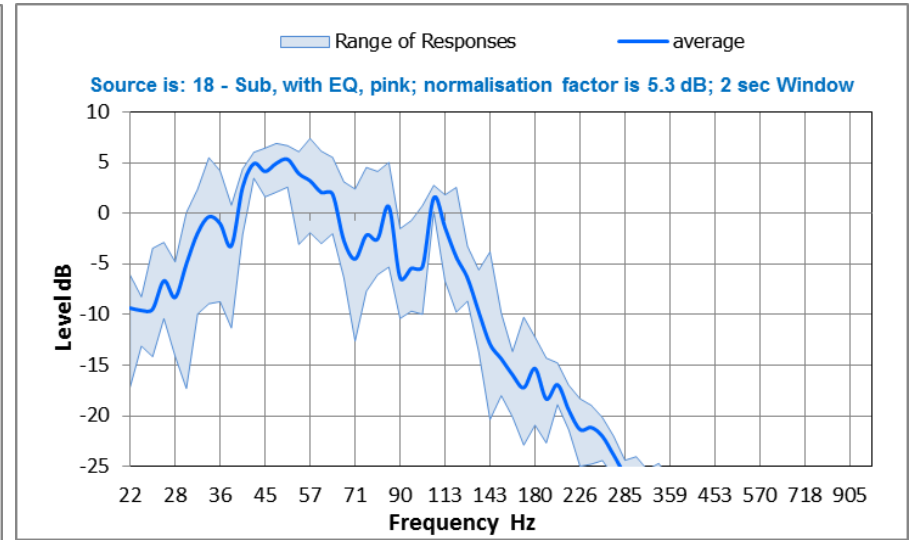

Figure E 11 Dubbing Stage E Comparison of average LFE responses with eq with 2 sec window. Responses normalized.

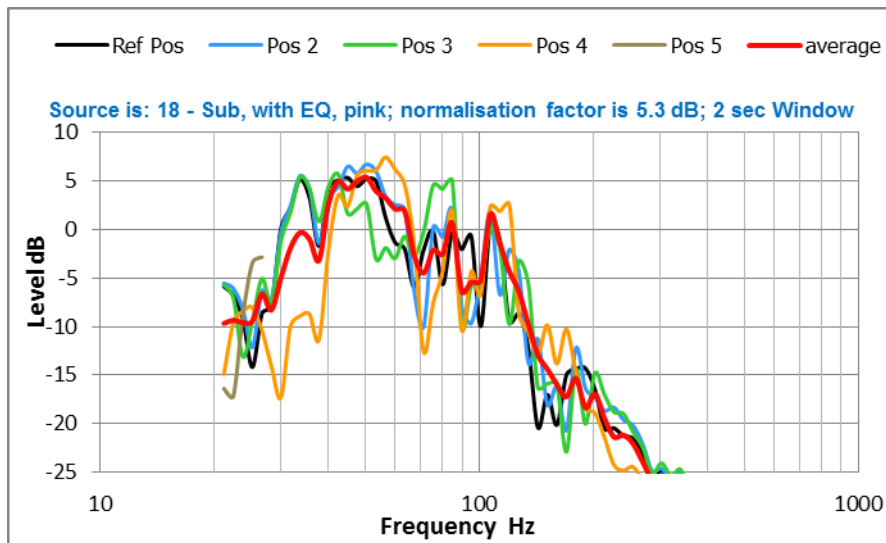

Figure E 12 Dubbing Stage E Comparison of individual responses in listening area for LFE channel with 2 sec window. Responses normalized..

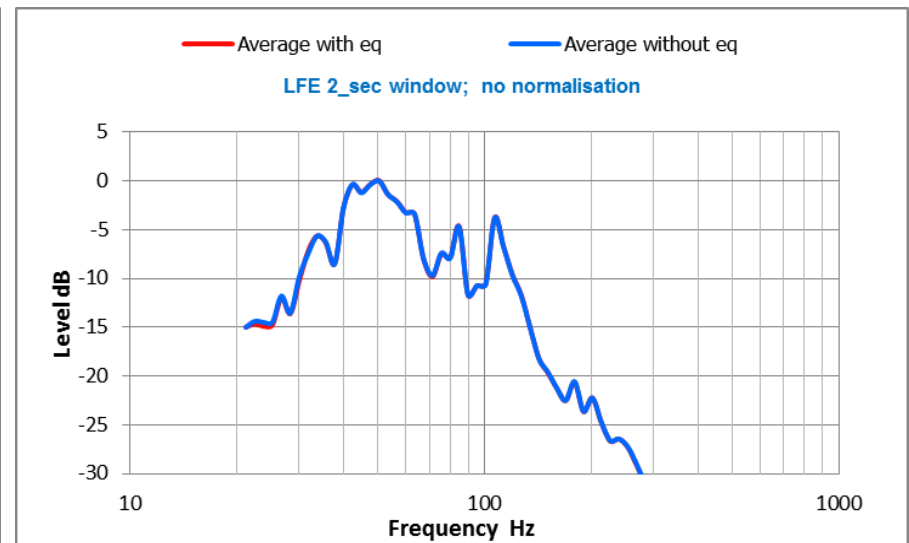

Figure E 13 Dubbing Stage E Comparison of average responses of LFE channel with and without equalization. Note that it appears that EQ was not applied to this system.

19.7 Surround channels

The following figures show responses for the Surround channels with equalization based on a 48 PPO window:

- Figure E 14 compares the responses at the reference position of the left, left side, and left rear channels.
- Figure E 15 compares the average responses of the above three channels.
- Figure E 16 compares the responses for the left side channel at each position with the average.
- Figure E 17 compares the responses for the left rear surround channel at each position with the average.
- Figure E 18 compares the responses for the left surround channel at each position with the average.

19.7.1 Discussion of Results

- This Dubbing Stage is another case where the surround channels extend down to 30 Hz.
- The ragged responses and level differences are inevitable given the multiple sources and the asymmetrical relative positioning of the microphones to each source, however the overall response shapes of each of the configurations is relatively similar.
- Once again, the X-curve has clearly evident, and given the absence of a screen, it must have been applied by equalization.

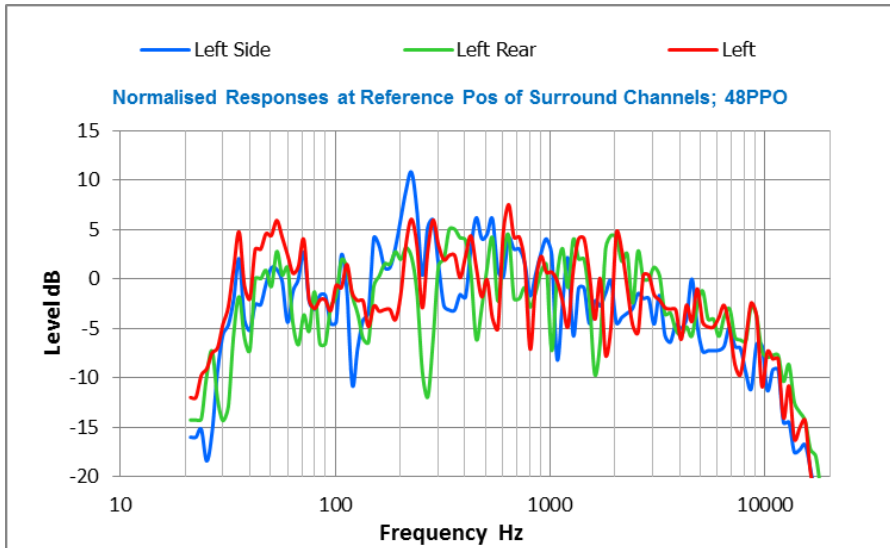

Figure E 14 Dubbing Stage E Comparison of responses at Reference Position for Surround channels with 48 PPO window. Responses normalized to average level of Ref position.

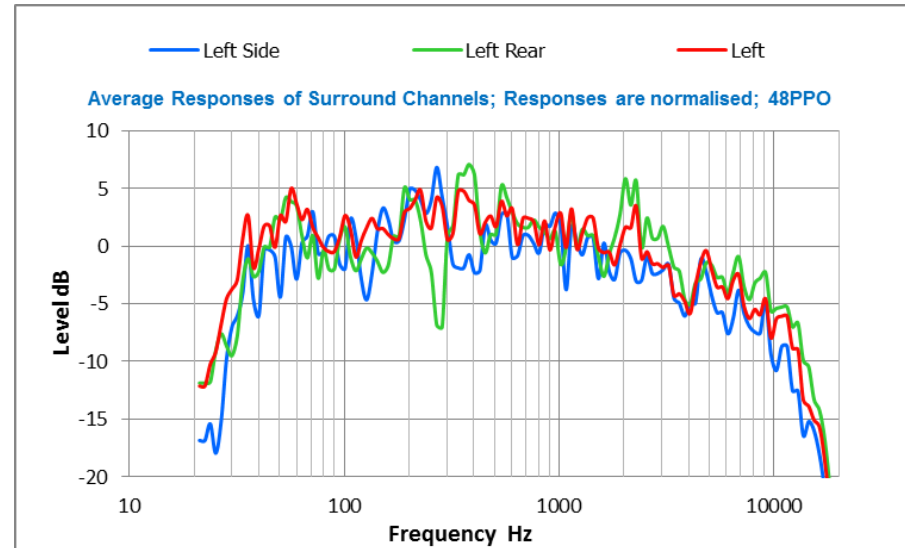

Figure E 15 Dubbing Stage E Comparison of average responses over listening area for Surround channels with 48 PPO window. Responses normalized to average level of Ref position.

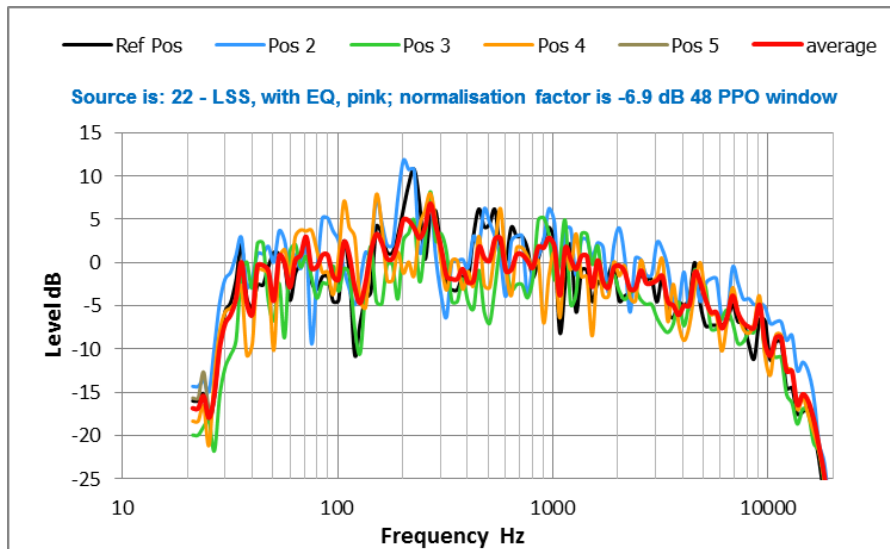

Figure E 16 Dubbing Stage E Comparison of responses in listening area for Left Side Surround channel with window. Responses normalized to average level of Ref position.

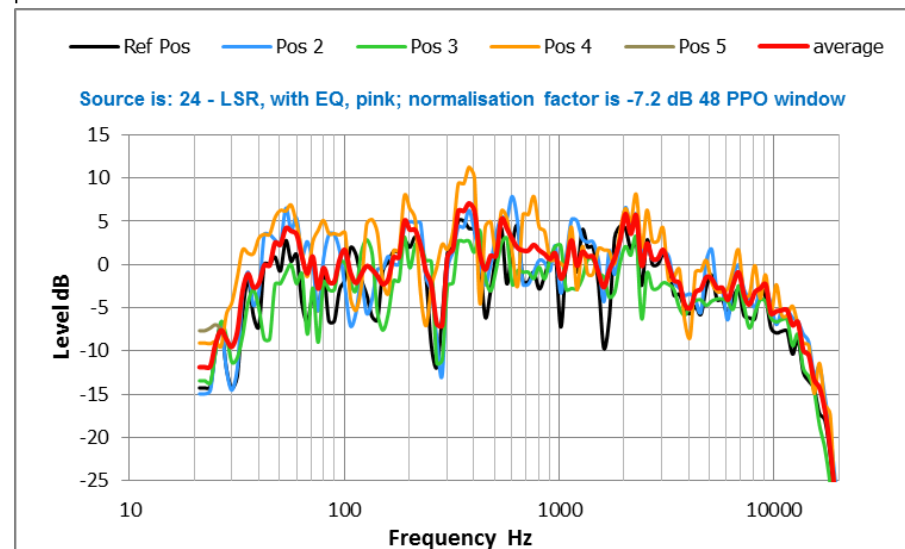

Figure E 17 Dubbing Stage E Comparison of responses in listening area for Left Surround Rear channel with window. Responses normalized to average level of Ref position.

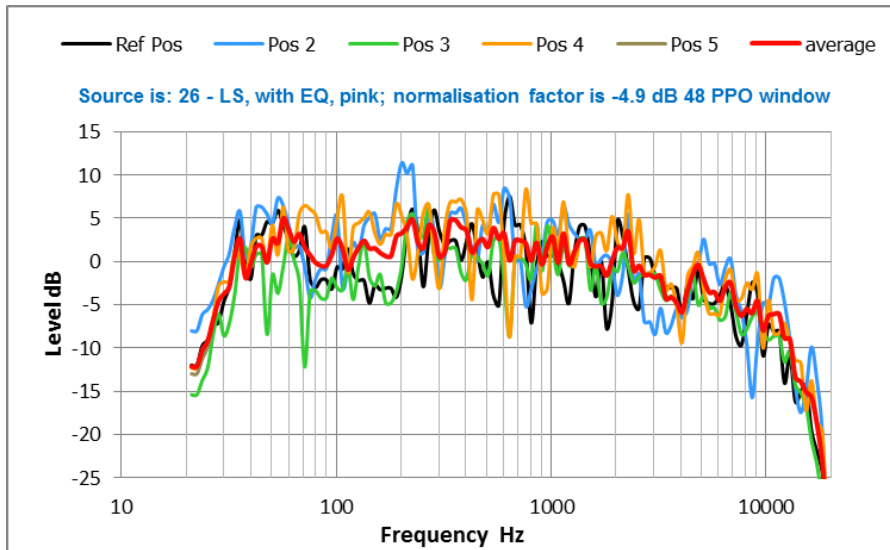

Figure E 18 Dubbing Stage E Comparison of responses in listening area for Left Surround channel with 48 PPO window. Responses normalized to average level of Ref position.

19.8 Room Acoustic Measures

Temporal parameters that have been derived from the impulse response of the Centre Channel at the Reference position are shown in the following figures.

- Figure E 19 shows the impulse response filtered to the range of 500 Hz to 4 kHz
- Figure E 20 shows the Schroeder decay curve associated with the impulse response
- Figure E 21 shows the reverberation times computed from the Schroeder decay range of -20 dB to -40 dB.
- Figure E 22 shows the cumulative energy in octave bands.

19.8.1 Discussion of Results

- The impulse responses and the Schroeder decay plot show excellent smoothness of decay for a room of about 500 ms decay time,
- There is a reasonably strong reflection being evident about 15 ms after the first arrival.
- The reverberation time is perhaps slightly on the high side in the mid frequencies, but the low-frequency control is excellent. Overall, the consistency of reverberation times is very good.
- The cumulative energy response shown is very good, the compactness of the curves indication good uniformity.
- Compared to some of the cinemas, the buildup of sound in 63 Hz and 125 Hz octave bands is remarkably rapid, with sound at 63 Hz being within 2 dB of its steady state level within 30 ms of the arrival of the direct field

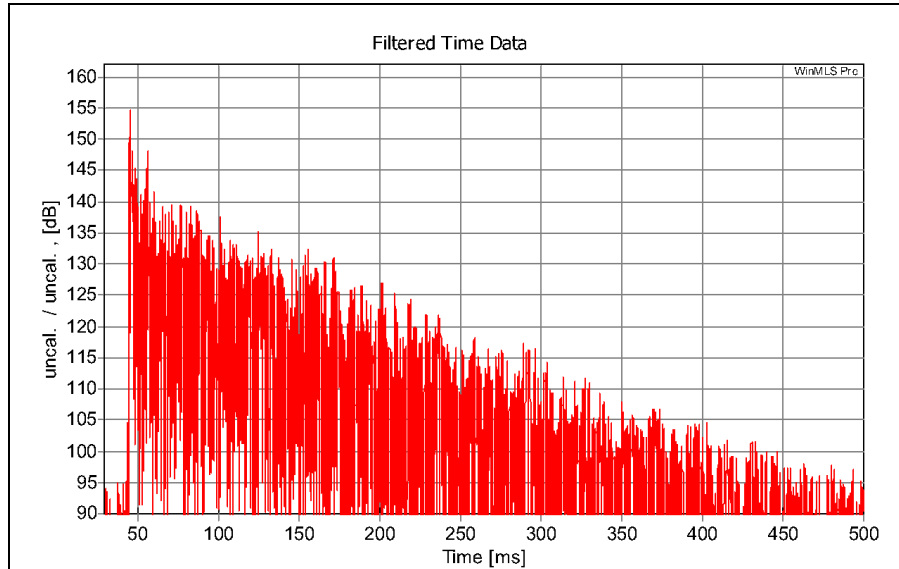

Figure E 19 Dubbing Stage E Impulse Response filtered 500 Hz to 4

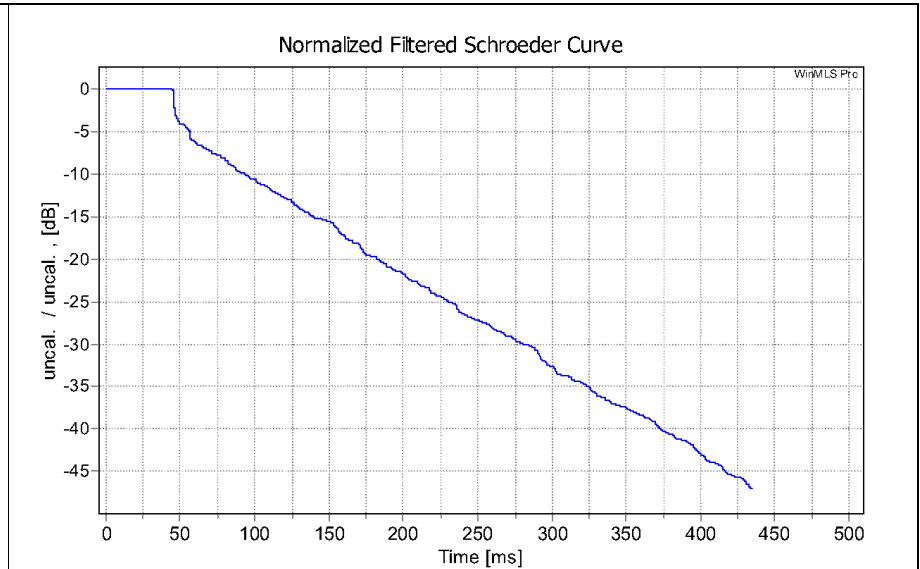

Figure E 20 Dubbing Stage E Schroeder decay plot filtered 500 Hz to 4 kHz

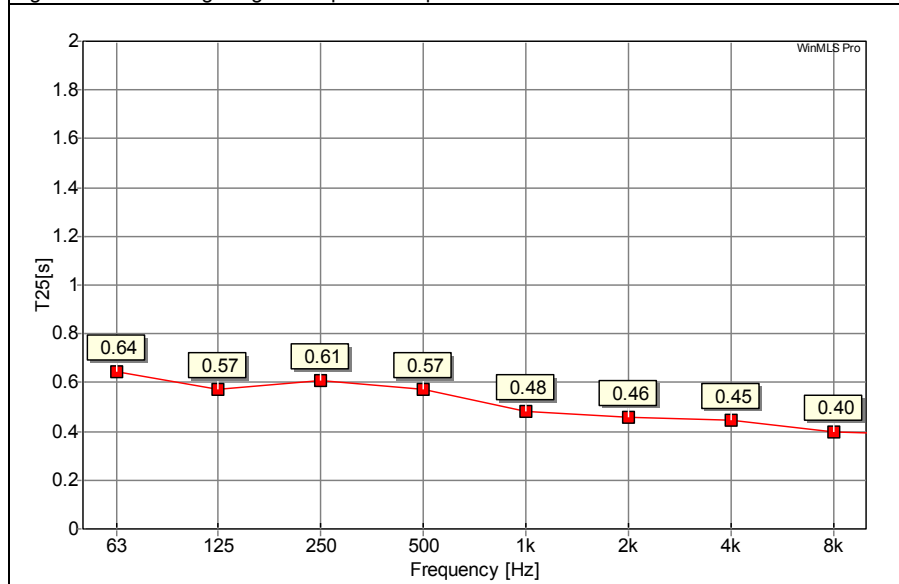

Figure E 21 Dubbing Stage E Reverberation times taken over decay range -15 dB to -25 dB

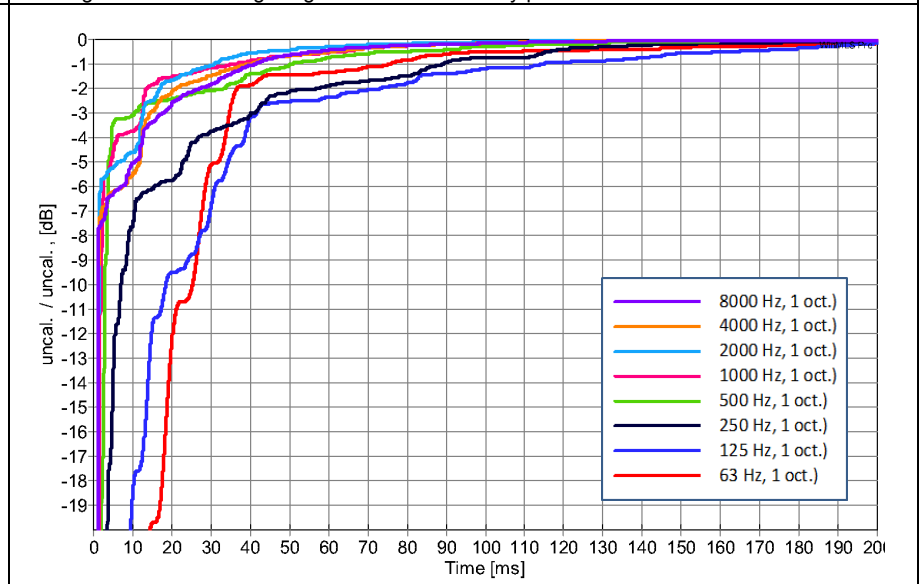

Figure E 22 Dubbing Stage E Cumulative energy in octave bands.

20 RESPONSES OF DUBBING STAGE F

20.1 Centre Channel

20.1.1 Audience positions

Figure F 1 shows the response at the reference position and the range of responses over all the listening positions with the three time windows. Figure F 2 shows the average response and the range of responses with the three time windows. Figure F 3 compares the average response with the individual position responses

20.1.1.1 Discussion of Results

- The low-frequency response nominally extends down to 40 Hz, but there is still useful output at 30 Hz. The roll off is not as steep as in some of the other venues.
- The reference position responses show an elevated response between about 60 and 120 Hz, also noticed in some other venues. The notches around 90 Hz and 150 Hz have the appearance of cancellations due to reflections from hard surfaces.
- There is a high degree of similarity between the 50 ms, 48 PPO and 2 s responses, which indicates that the bulk of the sound is arriving within the first 50 ms.
- Many of the notches and peaks in the average response will have resulted from local reflections from the console and producers area.
- The overall shape of the response at each position is very similar.

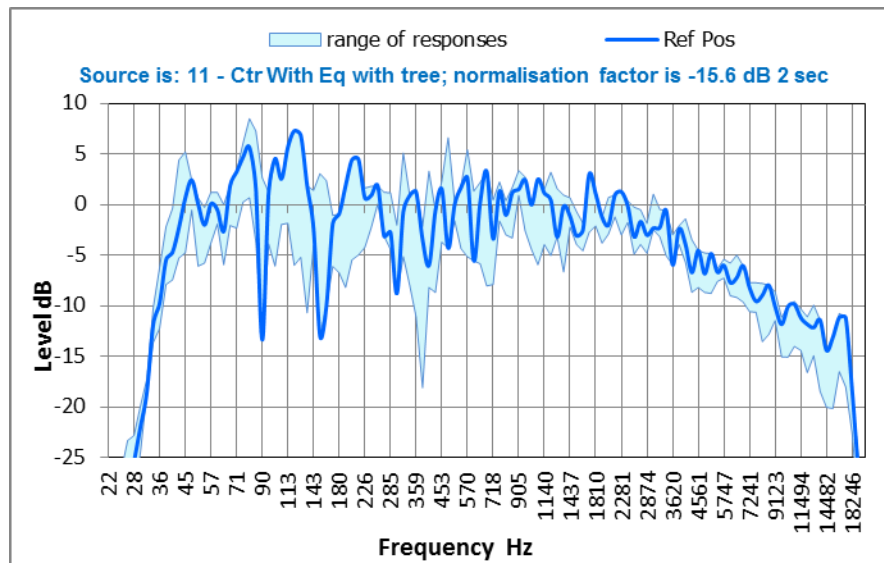
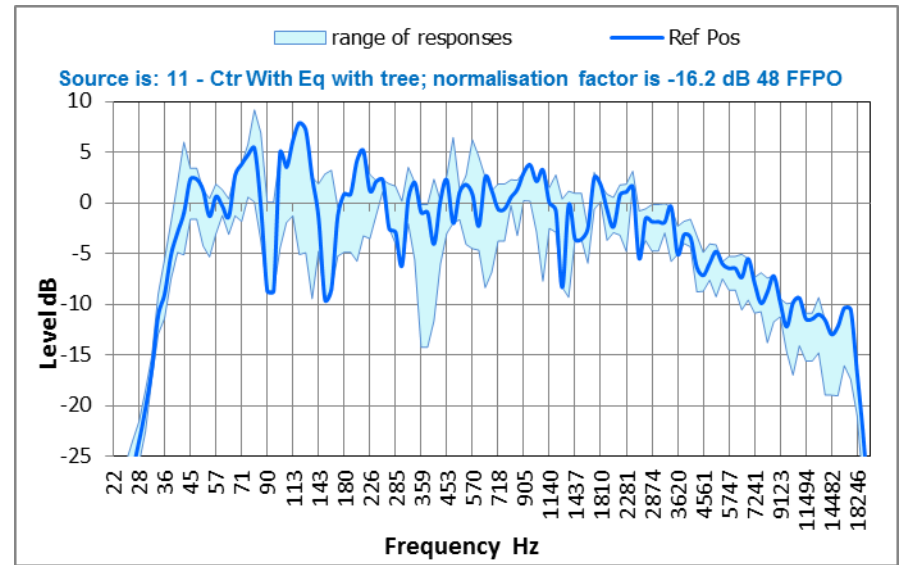
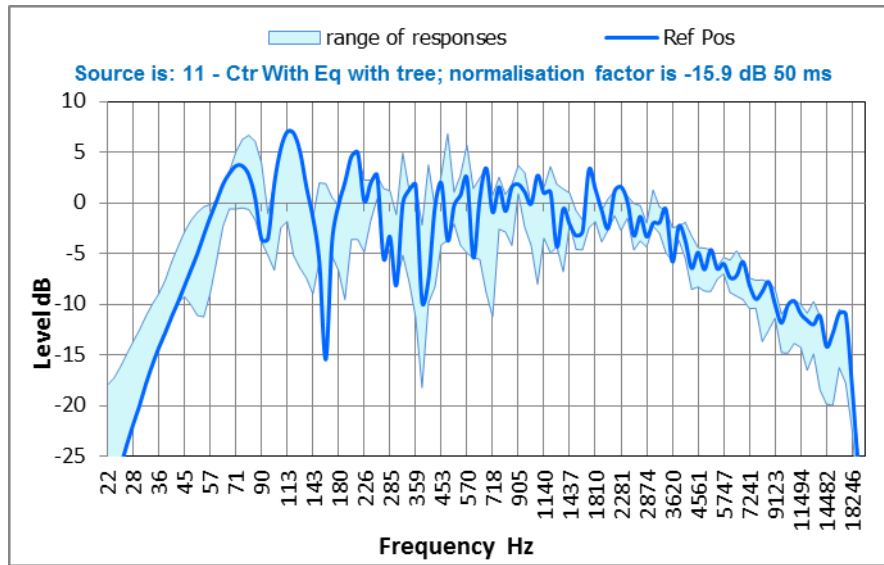

Figure F 1 Dubbing Stage F Comparison of mic positions and time windows for given source. Responses have been normalized'.

F 1

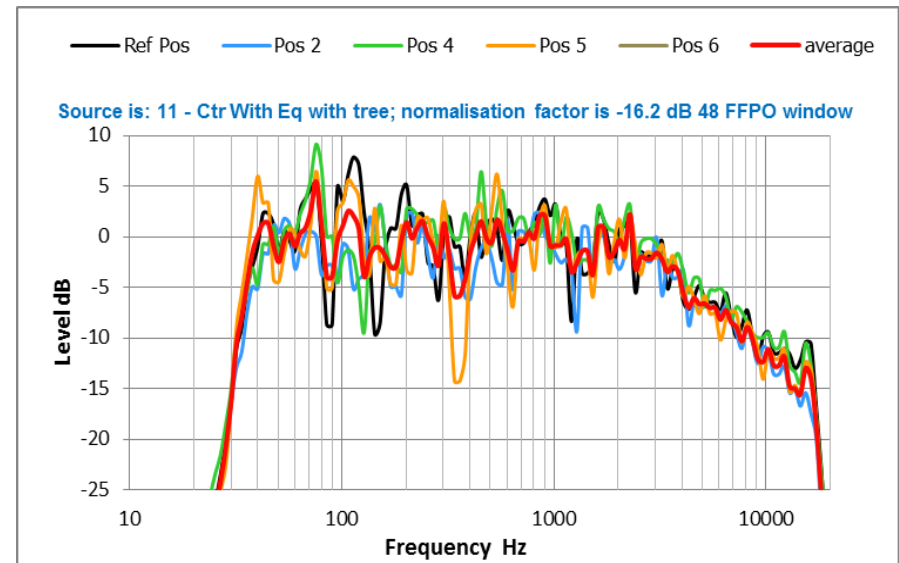
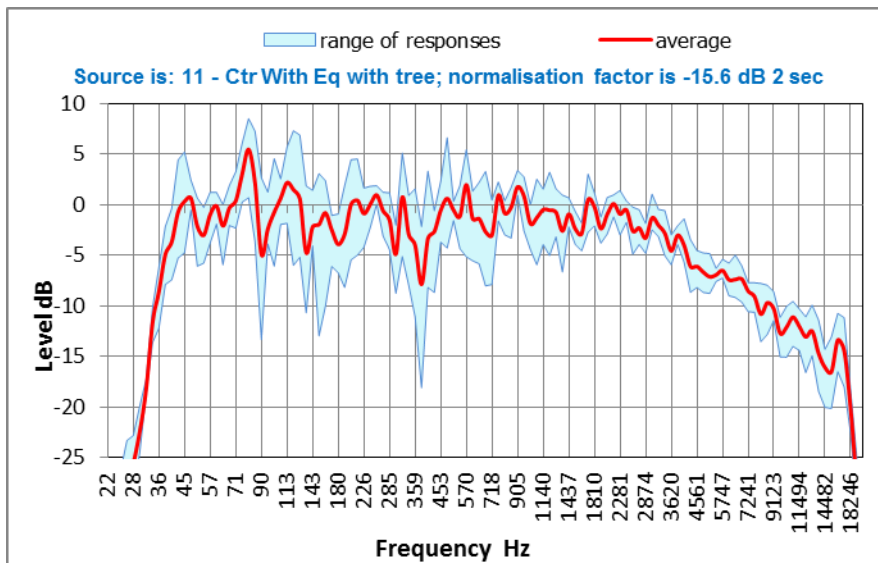
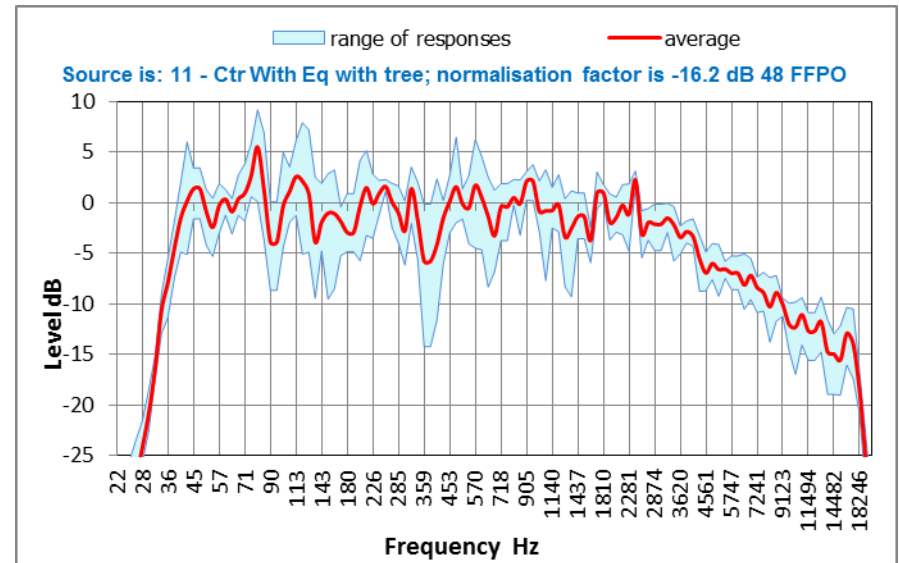
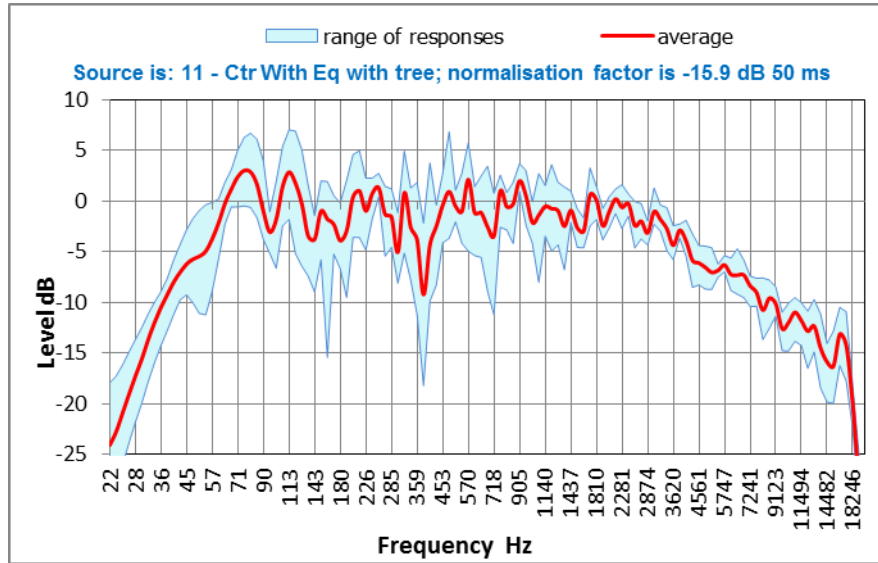

Figure F 2 Dubbing Stage F Comparison of the average (pressure), maximum and minimum responses and time windows for given source. Responses have been normalized.

Figure F 3 Dubbing Stage F Comparison of the average (pressure) and positional responses and time windows for 48 PPO. Responses have been normalized.

20.2 Comparison of close-field (tree) and listening-area microphone positions for Center Channel

Figure F 4 compares the measured response at the reference position with the responses at the tree microphones. Figure F 5 compares the average listening position response with the response at the tree microphone. The time window used is 48 PPO.

20.2.1 Discussion of Results

- The strong similarity between the general responses of the tree microphone and those of both the listening position and average response suggests a number of things:
 - The loudspeaker drivers comprising the center channel are located close together allowing the tree mics to be reasonably equidistant to each driver.
 - Reflections and reverberation in the room is only having a very minor effect on the sound emanating from the loudspeakers.
- The principal difference between close-field responses and the reference position and average responses in the far field is the gradual reduction in HF level as the frequency increases. This gradual reduction is commensurate with air-absorption losses. Some minor directivity losses (from the loudspeakers or microphones) may also be responsible in the additional roll-off shown in the far-field responses.

20.3 Comparison of Center Channel responses with different time windows at reference position

Figure F 6 compares the responses at the reference position of four time windows by referencing the response of each window to the 2 second response. Sections of the following responses are not shown, due to the lack of resolution resulting from time/frequency trade-offs:

- 10 ms windowed response below 150 Hz
- 50 ms windowed response below 50 Hz

20.3.1 Discussion of Results

- Above 1.5 kHz the responses of all time windows are very similar indicating the direct field dominates the response.
- There are reflections that arrive during the first 10 ms that cause a notch at 1 kHz. As later energy arrives, this notch becomes “filled in”.

20.4 Effect of equalization on Center Channel and X curve

Figure F 7 shows the effect of equalization on the Center channel response at the reference position, along with the published X curve. To show the relative levels, the responses were not normalized.

20.4.1 Discussion of Results

- In order to match the X curve, the high frequency response is *reduced* with equalization. This is certainly due to the presence of a woven screen, which attenuates the high frequencies far less than a perforated screen (**Error! Reference source not found.**).



- In general, very little equalization has been applied to the lower frequencies.

20.4.2 X curve issues

- The equalized response from 3 kHz upwards is actually on the low side of the standard X-curve. Although ST202 suggests modification of the X-curve based on number of seats. It seems that these modifiers have not been applied for alignment of this venue.
- Considering the fact that Dubbing Stage F is both small and acoustically dry, this would imply a need, if the X-curve modifiers of ST202 are accurate, for the HF response to show a markedly less rolled-off response.
- In fact, the roll-off characteristics are very similar to those of the largest and most reverberant cinemas in this report, i.e. Venues A and C. Given that there is no evidence of significant steady-state buildup at high frequencies, the response suggests that there may have been a conscious attempt to closely match the perceived HF response of Venue F with the exhibition theatres.

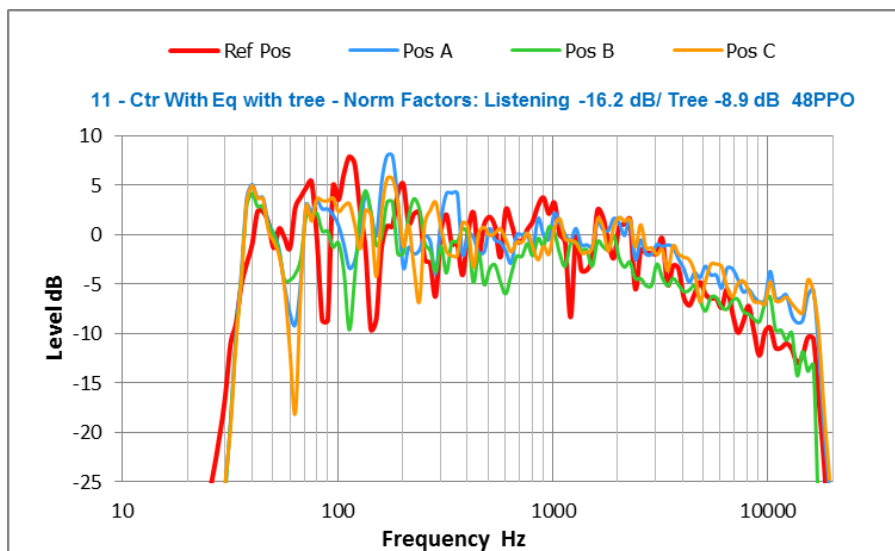

Figure F 4 Dubbing Stage F Comparison of responses at Tree Mics with response at reference mic. for Center Ch and 48 PPO window. Tree responses normalized to Pos B.

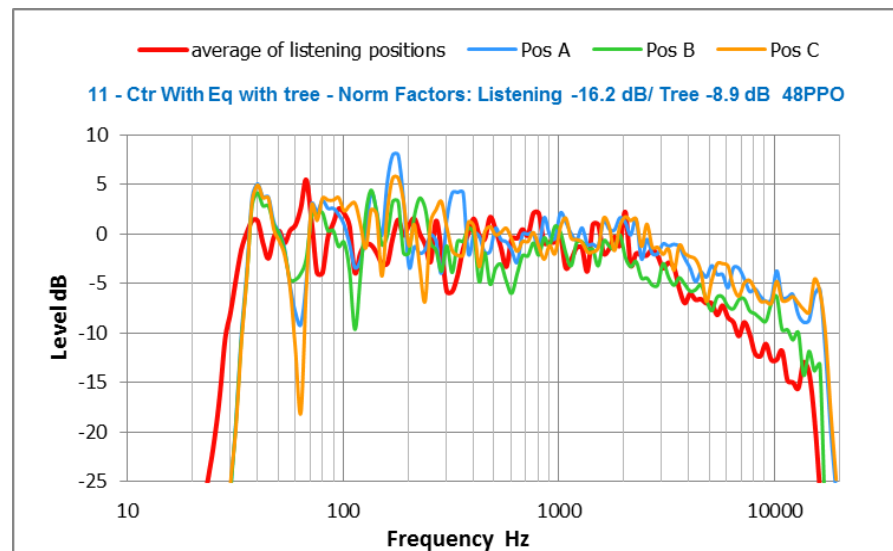

Figure F 5 Dubbing Stage F Comparison of average listening response with tree position microphones for Center Ch and 48 PPO window. Tree responses are normalized to Pos B.

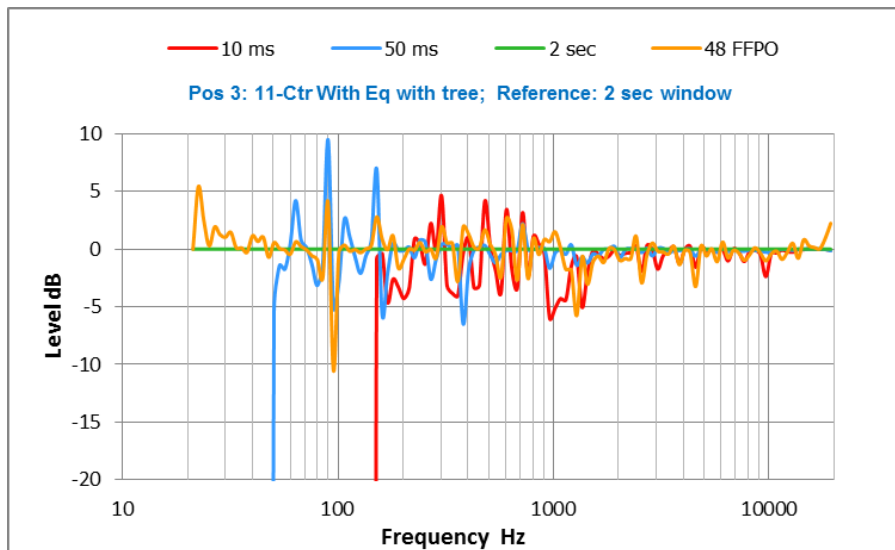

Figure F 6 Dubbing Stage F Responses with different windows at ref position Center Channel. NB 10 ms and 50 ms responses are truncated according to the time/frequency limit. Data is normalized.

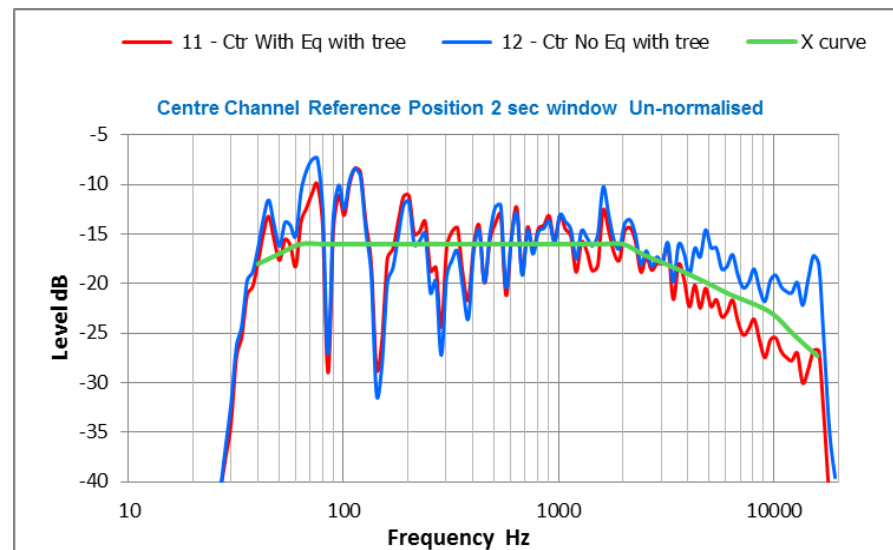

Figure F 7 Dubbing Stage F Comparison of responses of Centre Channel with & without equalization with X curve at reference position. Data is not normalized.



20.5 Comparison of front channels and time windows at Reference position

The responses of the left, center and right channels are shown for the three time windows.

- Figure F 8 A/B/C compare the responses at the reference position of the left, center and right channels.
- Figure F 8 D shows the overall range of responses of the three channels.
- Figure F 9 A/B/C compares the average response of the three channels.

20.5.1 Discussion of Results

- Compared to the center channel, both the average and reference responses of the left and right channels are slightly higher below 100 Hz and slightly lower up to 150 Hz. These differences are consistent with the different acoustic loading that these outer loudspeakers receive from being relatively close to the side walls.
- The left-to-right matching is excellent.

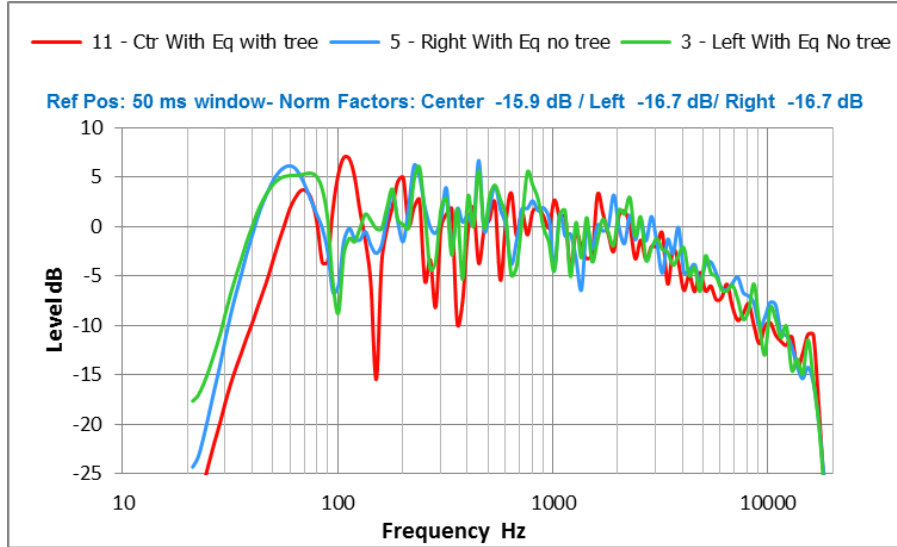

A 50 ms window.

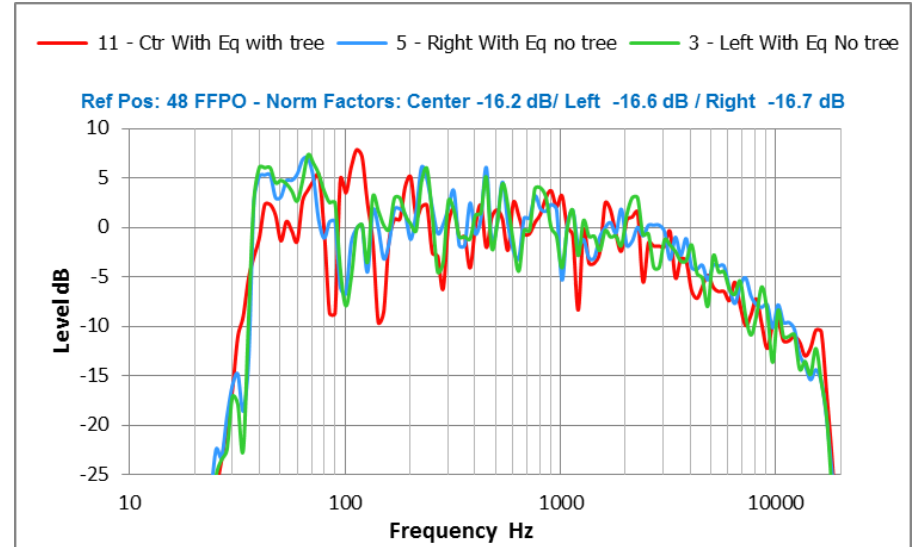

B 48 PPO window.

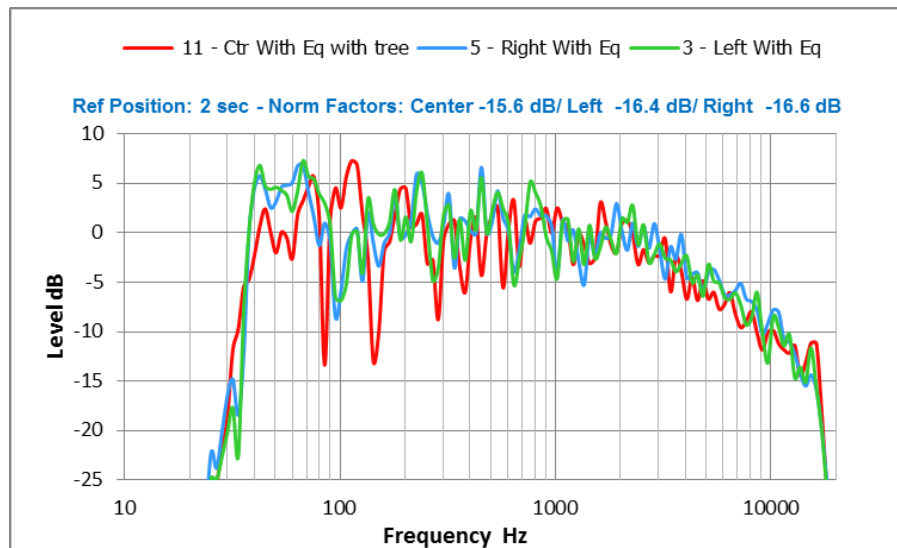

C 2 second window .

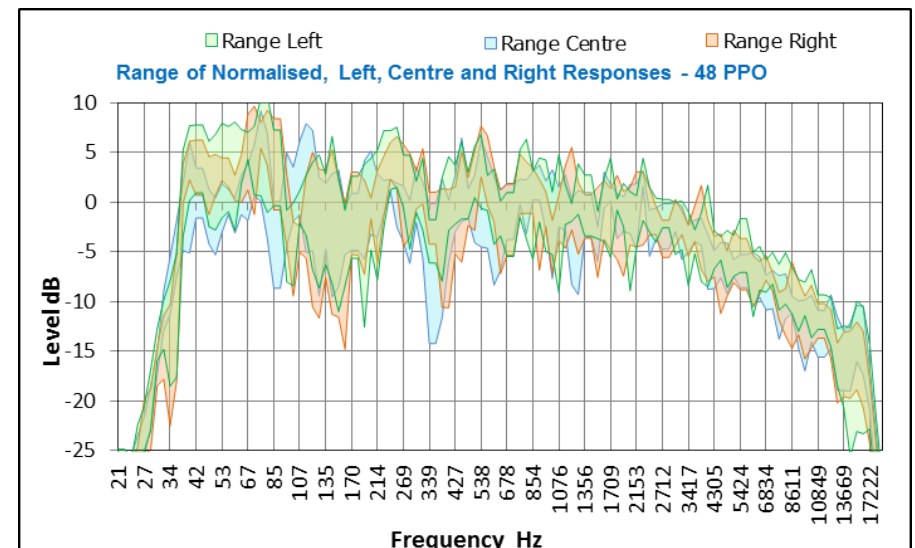

D 48 PPO window.

Figure F 8 A, B and C: Dubbing Stage F Comparison of L,C,R responses with equalization at reference position with time windows as noted. Responses are normalized. D: Comparison of maximum and minimum extremes over listening positions.. Responses are normalized.

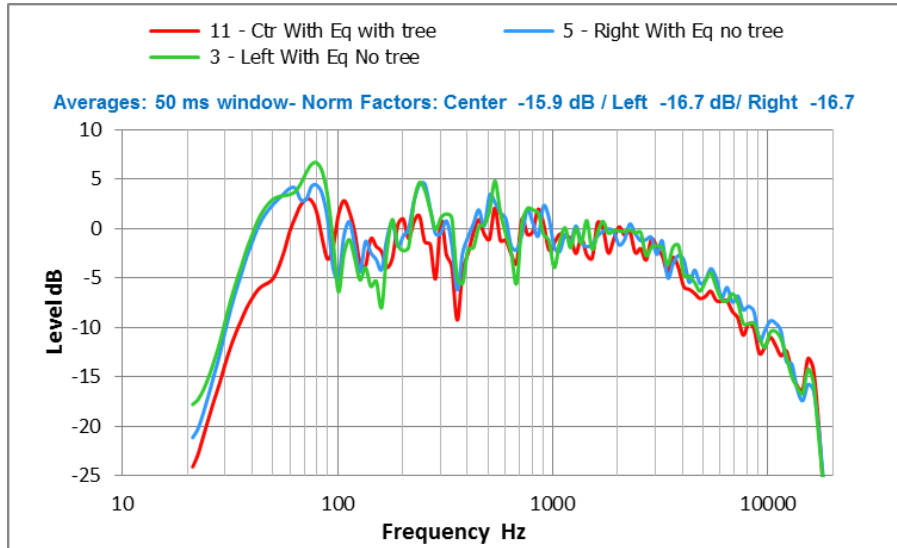

A 50 ms window

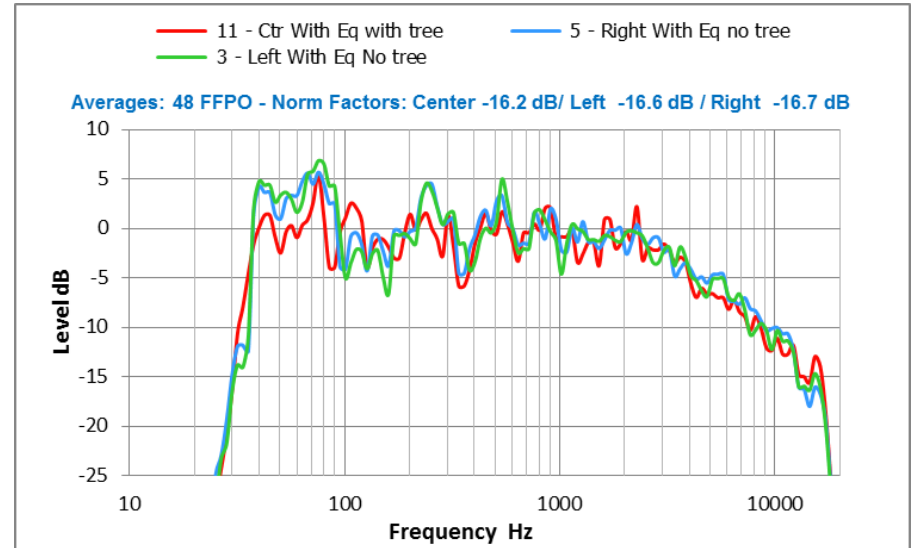

B 48 PPO window

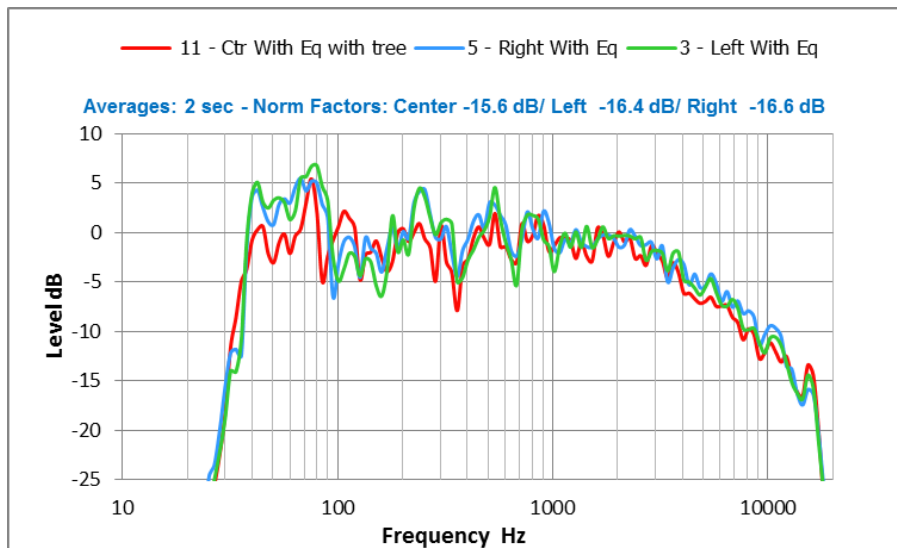

C 2 second window

Figure F 9 A, B, C Dubbing Stage F Comparison of average L,C,R responses with equalization with time windows as noted. Responses are normalized prior to averaging.

20.6 LFE Channel

The following figures show responses for the LFE channel based on a 2 s window:

- Figure F 10 compares the response at the reference position with the range of responses over the microphone positions.
- Figure F 11 shows the average response over the listening area and the range of responses over the microphone positions.
- Figure F 12 compares the responses at the five microphone positions.

In the above figures, the responses have been normalized to the average level of the Reference position over the range 40 Hz to 100 Hz.

Figure F 13 compares the average response over the listening area with and without the as-found equalization. To allow assessment of the effect of equalization on the overall level of the LFE channel, normalization was not applied to these responses.

20.6.1 Discussion of Results

- With the exception of a strong dip around 63 Hz, the LFE response is fairly flat.
- The consistency between measurement positions is unusually high.
- The low frequency response is very extended, with the roll off commencing at 23 Hz and extending useably to 20 Hz.
- The response is rolled-off above about 125 Hz, and no other equalization appears to have been applied.
- The reason for the dip at 63 Hz is not clear, but as it appears in the average response, it may be due to the effect of a boundary close to the loudspeaker,
- The overall response is very good.

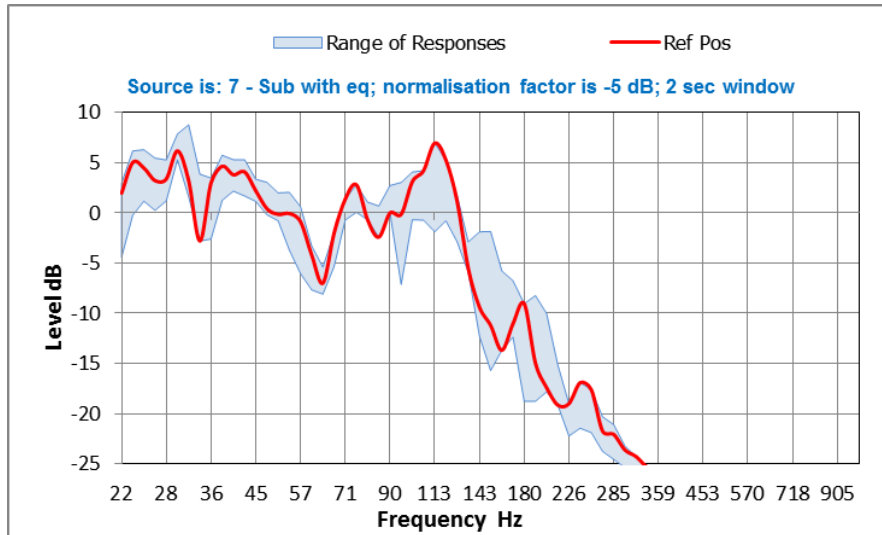

Figure F 10 Dubbing Stage F Comparison of extremes in responses over listening area for LFE channel with 2 sec window with equalisation. Responses normalized.

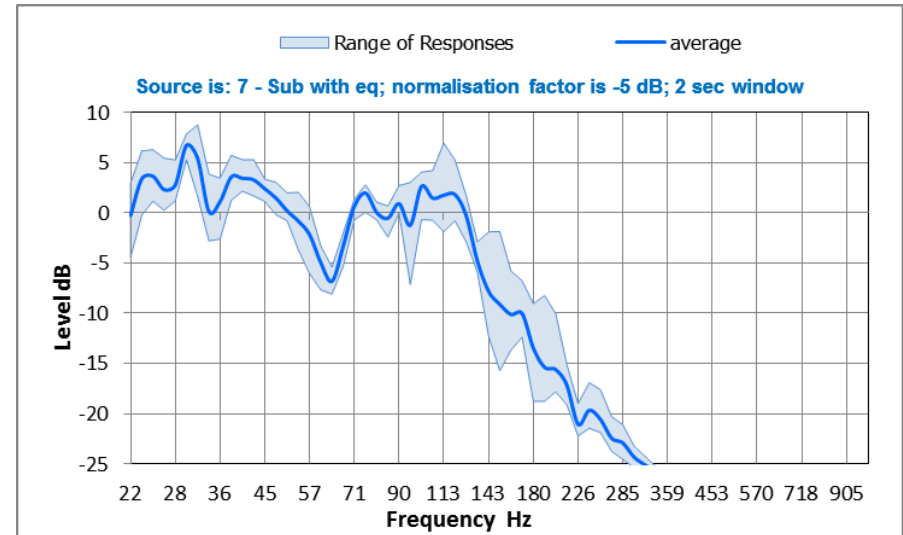

Figure F 11 Dubbing Stage F Comparison of average LFE responses with eq with 2 sec window. Responses normalized.

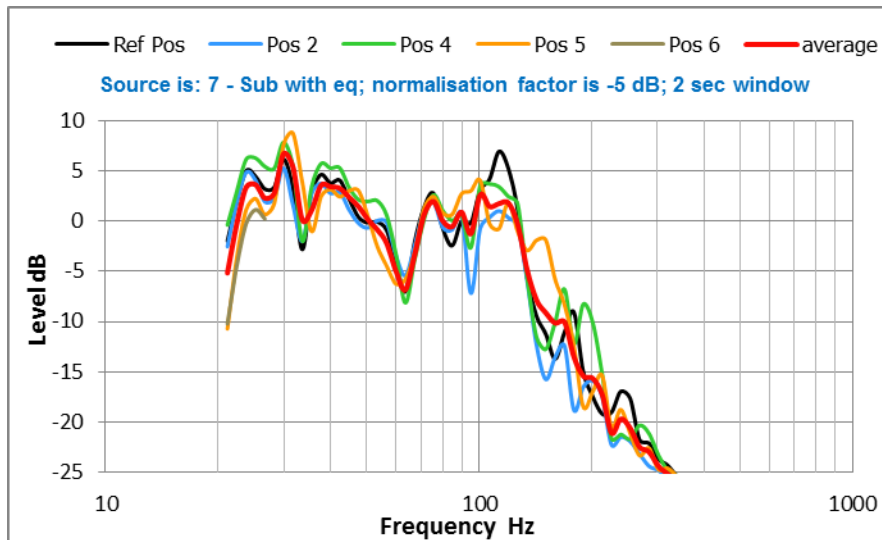

Figure F 12 Dubbing Stage F Comparison of individual responses in listening area for LFE channel with 2 sec window. Responses normalized..

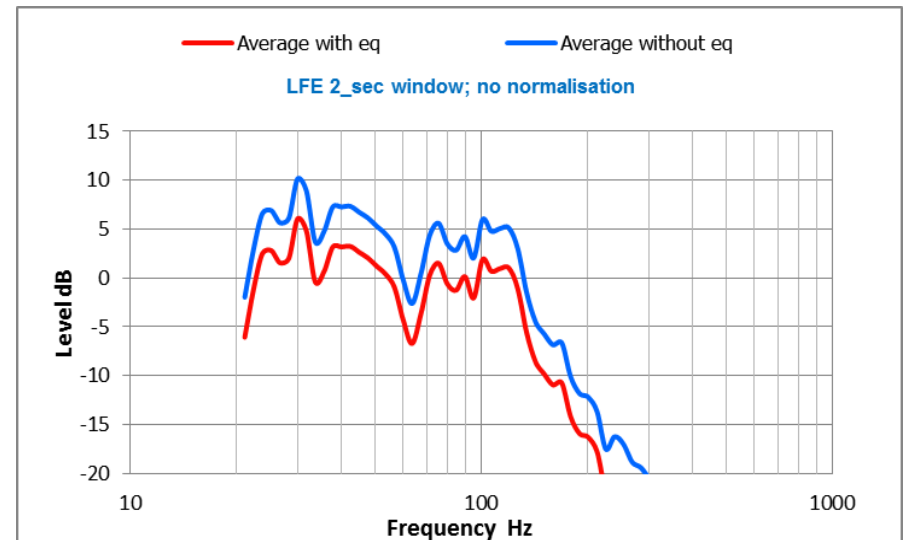

Figure F 13 Dubbing Stage F Comparison of average responses of LFE channel with and without equalization.

20.7 Surround channels

The following figures show responses for the Surround channels with equalization as found based on a 48 PPO window:

- Figure F 14 compares the responses at the reference position of the left, left side, and left rear surround channels.
- Figure F 15 compares the average responses of the above three channels.
- Figure F 16 compares the responses for the left surround channel at each position with the average.
- Figure F 17 compares the responses for the left side surround channel at each position with the average.
- Figure F 18 compares the responses for the left rear surround channel at each position with the average.

20.7.1 Discussion of Results

- The surround responses are reasonably typical.
- The low-frequency response extends down to approximately 55 Hz.
- Each of the three surround-channel average responses shows a depression of up to 5 dB between 2.5 kHz and 5 kHz. This depression may or may not be representative of the total listening area,
- The direct-field component of the sound produced by the surround channels will be subject to strong phase interference effects, due to the multiple loudspeakers. As the difference in paths lengths from each speaker to a given listener can be quite small, the bandwidth in Hz of the phase cancellations and peaks can be quite wide at mid and low mid frequencies, leading to noticeable changes in tonality with position.

However, the depression noted above is unlikely to be due to phase interference effects, as its frequency range is too wide; viz. for a phase cancellation of this width at 3.5 kHz to appear in the average response of five positions would require the differences between all speaker-to-listener path lengths to be approximately 50 mm. This situation is highly unlikely, and therefore these responses are attributable to other effects, such as intrinsic loudspeaker response or equalization.

- The high frequency responses generally follow the standard X-curve.
- Once again, the multiple sources make the response variations inevitable between the different arrays.

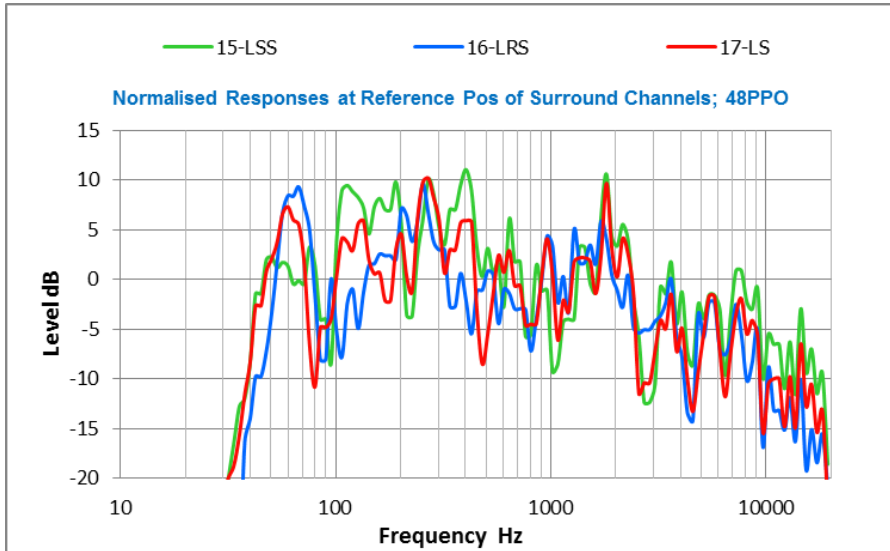

Figure F 14 Dubbing Stage F Comparison of responses at Reference Position for Surround channels with 48 PPO window. Responses normalized to average level of Ref position.

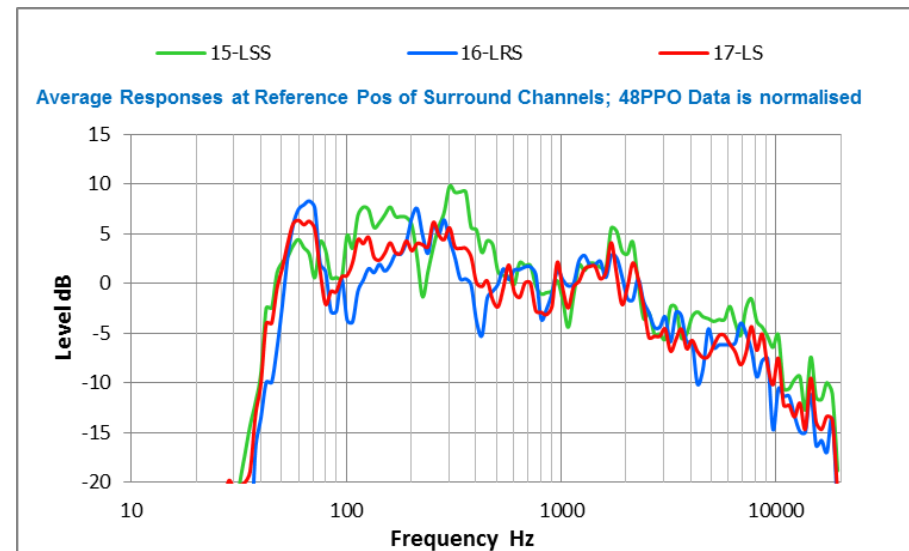

Figure F 15 Dubbing Stage F Comparison of average responses over listening area for Surround channels with 48 PPO window. Responses normalized to average level of Ref position.

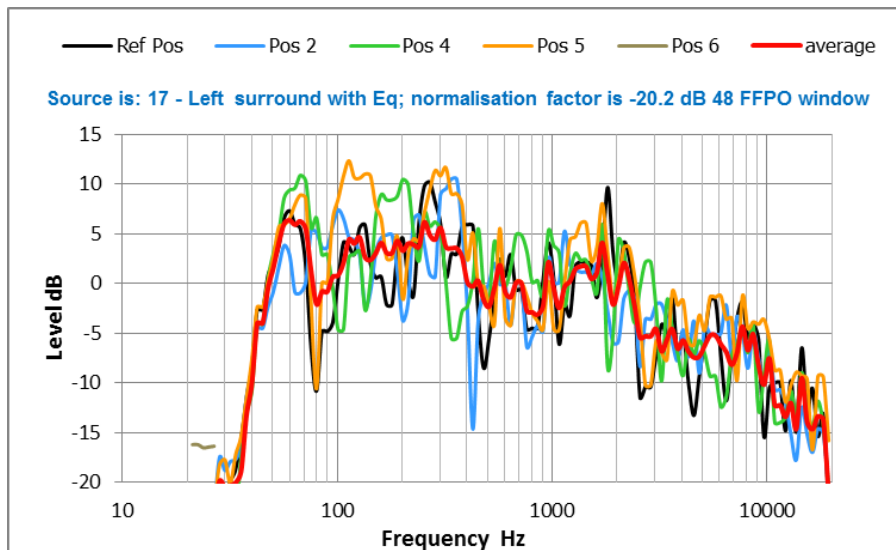

Figure F 16 Dubbing Stage F Comparison of responses in listening area for Left Surround channel with window. Responses normalized to average level of Ref position.

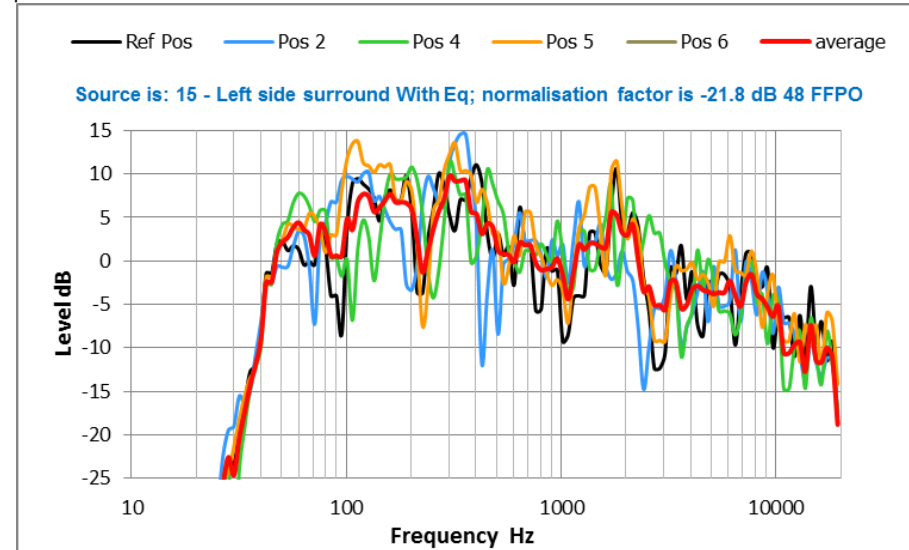

Figure F 17 Dubbing Stage F Comparison of responses in listening area for Left Side Surround channel with window. Responses normalized to average level of Ref position.

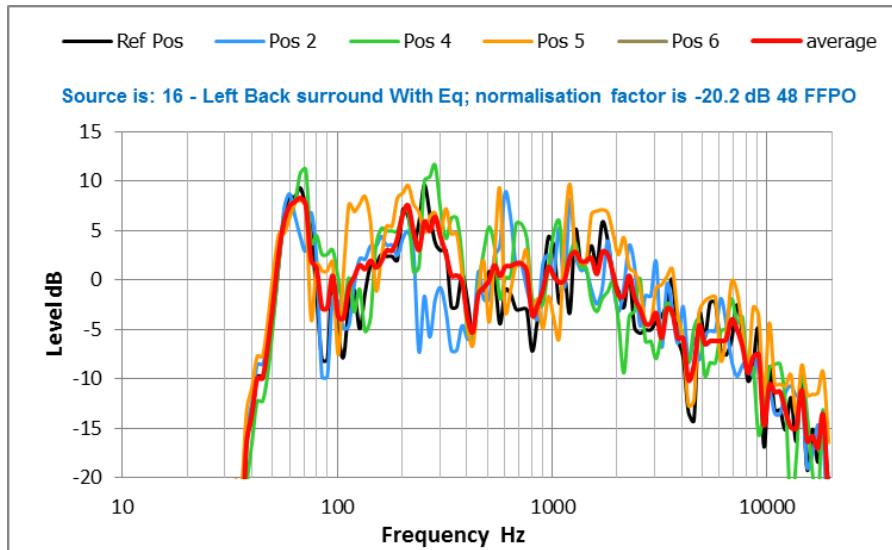

Figure F 18 Dubbing Stage F Comparison of responses in listening area for Left Rear Surround channel with 48 PPO window. Responses normalized to average level of Ref position.

20.8 Room Acoustic Measures

Temporal parameters that have been derived from the impulse response of the Centre Channel at the Reference position are shown in the following figures.

- Figure F 19 shows the impulse response filtered to the range of 500 Hz to 4 kHz.
- Figure F 20 shows the Schroeder decay curve associated with the impulse response.
- Figure F 21 shows the reverberation times computed from the Schroeder decay range of -20 dB to -40 dB.
- Figure F 22 shows the cumulative energy in octave bands.

20.8.1 Discussion of Results

- Both the impulse response and the Schroeder decay plot show excellent decay smoothness.
- Two early reflections are evident about 15 ms and 30 ms after the first arrival.
- The reverberation times are typical of a modern, well-designed dubbing theatre, with a mean value of around 260 ms and a variation of +/-35 ms. The fact that the RT vs. frequency plot shows bumps is insignificant when the decay times are so low. Variations of 70 ms between octave bands are subjectively inconsequential.
- The consistency of reverberation times across the frequency range is excellent.
- The cumulative energy plots are the most compact of all the six rooms tested in this report.
- The effects of the reflections at 15 ms and 30 ms can be seen as discontinuity in the build-up process.

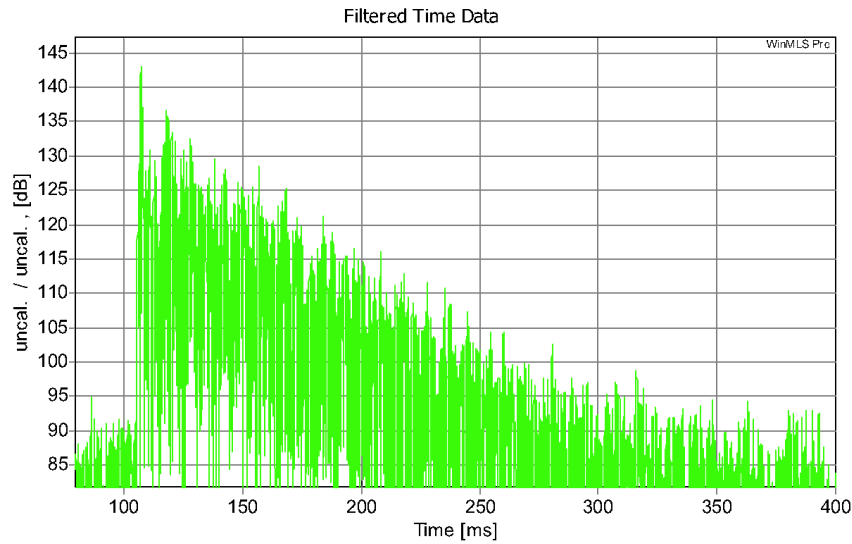

Figure F 19 Dubbing Stage F Impulse Response filtered 500 Hz to 4 kHz

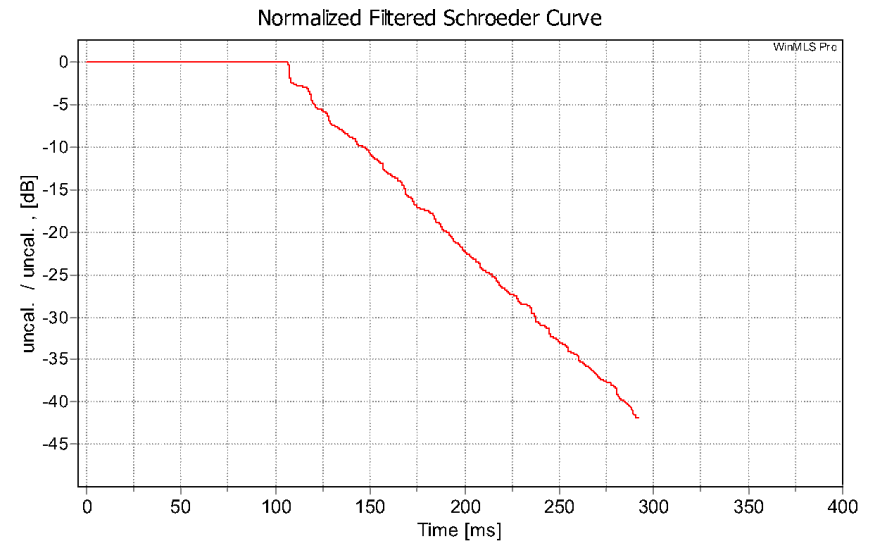

Figure F 20 Dubbing Stage F Schroeder decay plot filtered 500 Hz to 4 kHz

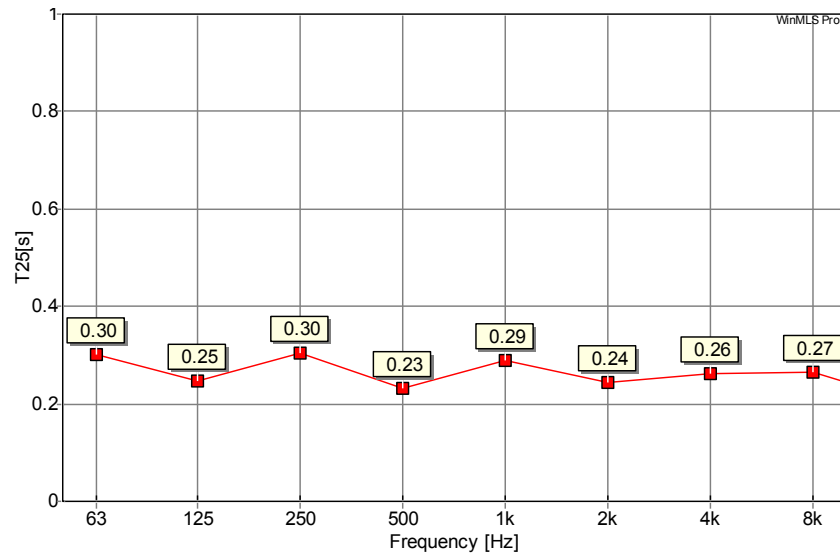

Figure F 21 Dubbing Stage F Reverb. times taken over decay range -15 dB to -25 dB

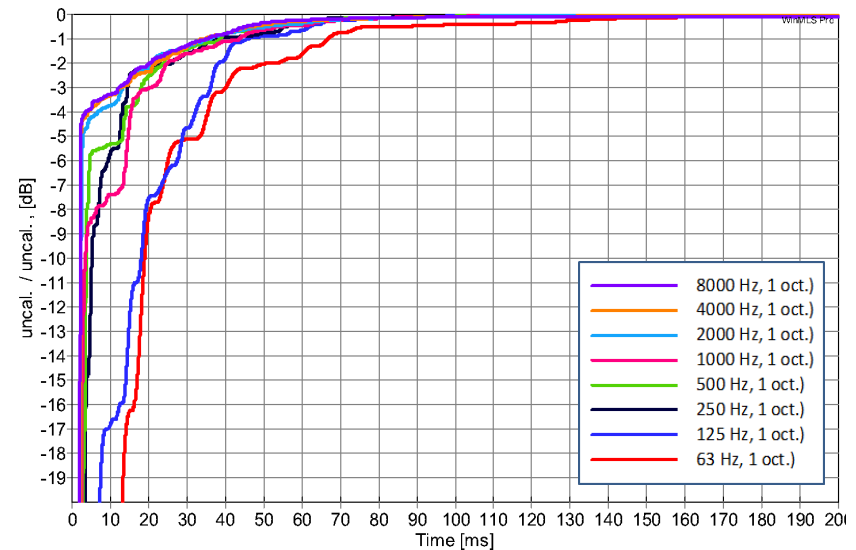

Figure F 22 Dubbing Stage F Cumulative energy in octave bands.

Annex A Venue Microphone Locations

A.1 Microphones Used

The microphones used in the venues are listed below.

Code	Microphone used	Capsule Size
B	Beyer MM-1	3/8"
A	Audix TM-1	1/4"
C	Audix TM-1	1/4"
D	Audix TM-1	1/4"
E	Audix TM-1	1/4"
F	Audix TM-1	1/4"

A.2 General Location of Microphones in Cinemas

For the cinemas the measurement microphones were placed in an X as indicated in Figure A1, which is adapted from ST 202:2010.

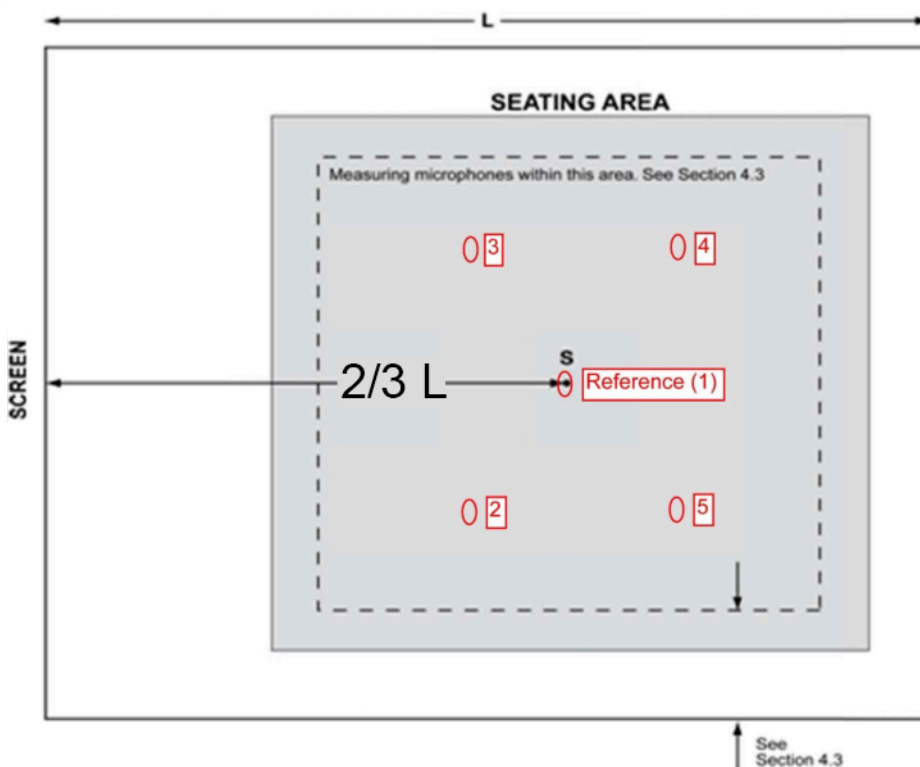

Figure Annex A 1 Microphone Placements – Cinemas (Source: SMPTE ST 202-2010 Figure 4)

"In one venue, the microphones were all placed to the right hand side of the reference position to see if more representative data could be obtained when the venue was symmetric. In the other cinema locations the measurement microphones were per Figure A1.

For the dubbing theatres the measurement microphones were generally positioned as indicated in Sections 0 and A.4.

A.3 Venue E (Dubbing Stage)

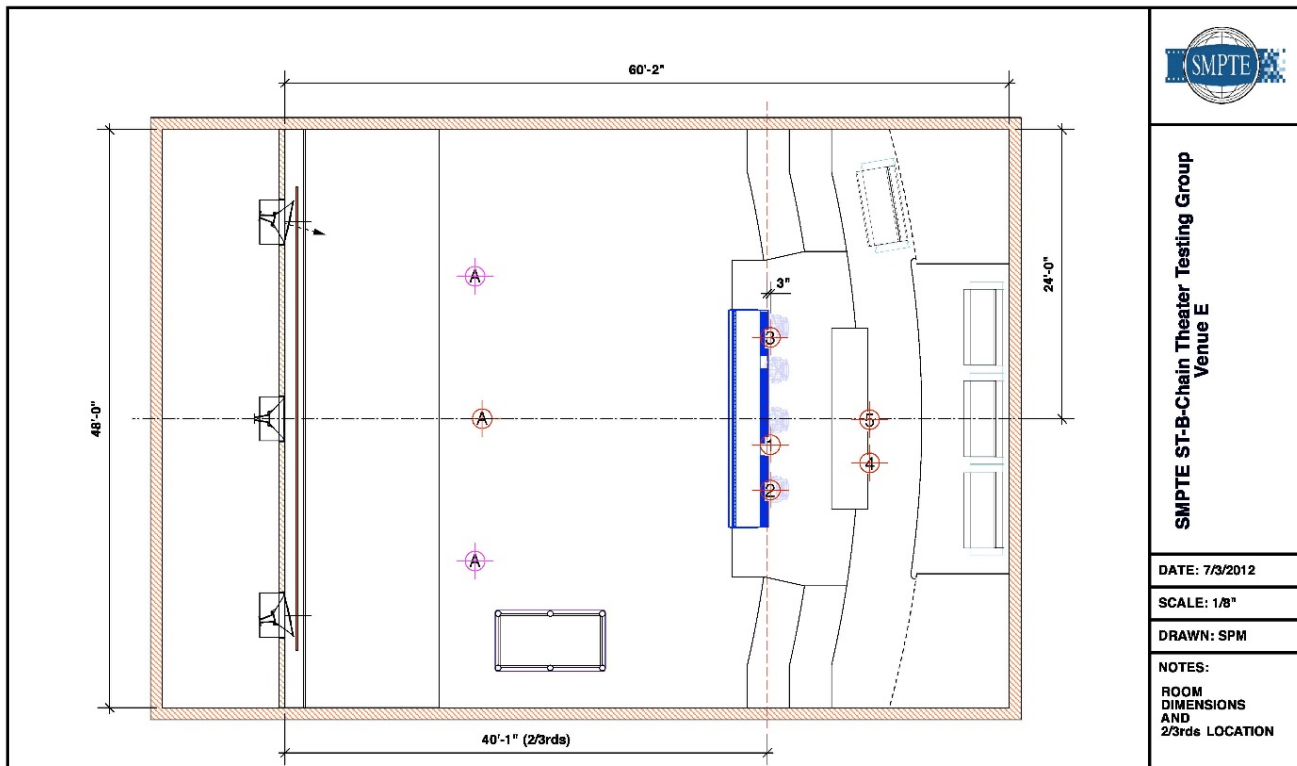
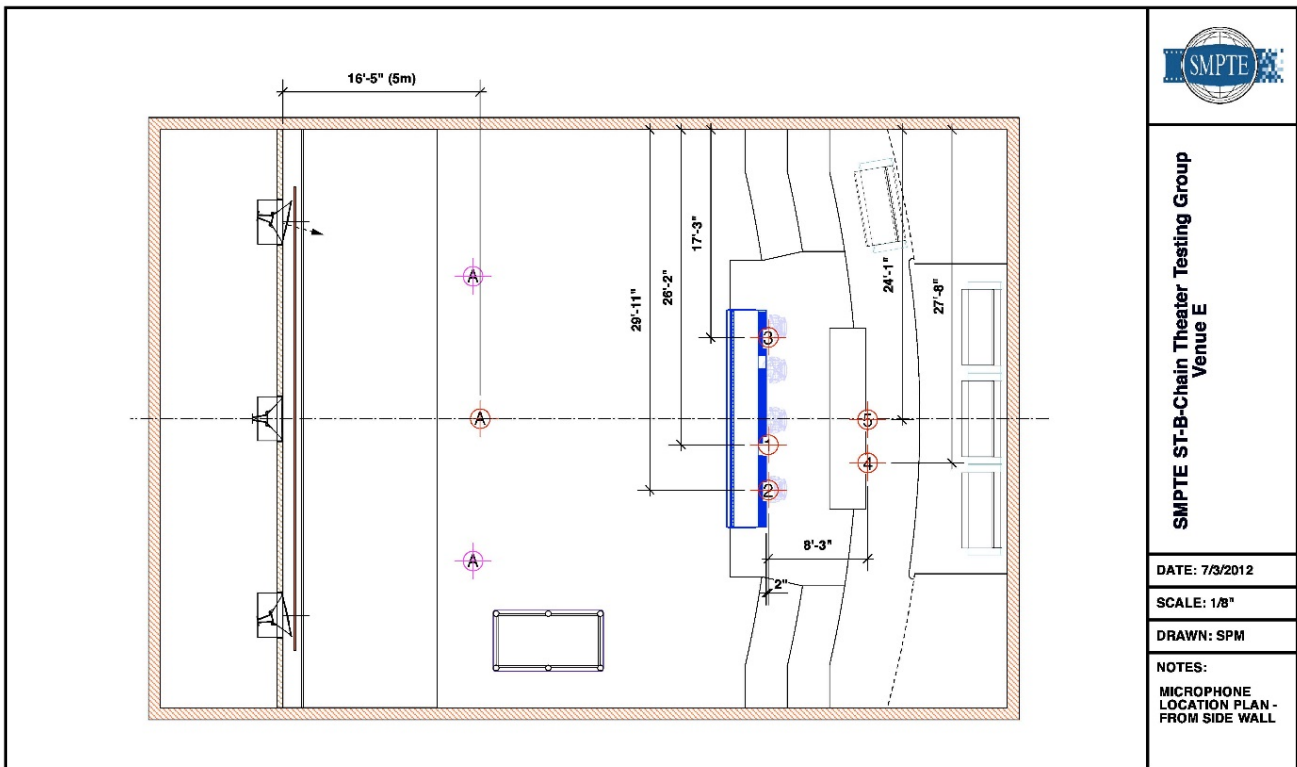

Figure Annex A 2 Plan view of Microphone Placements in Venue E (dubbing stage) Note the drawing is not to scale.

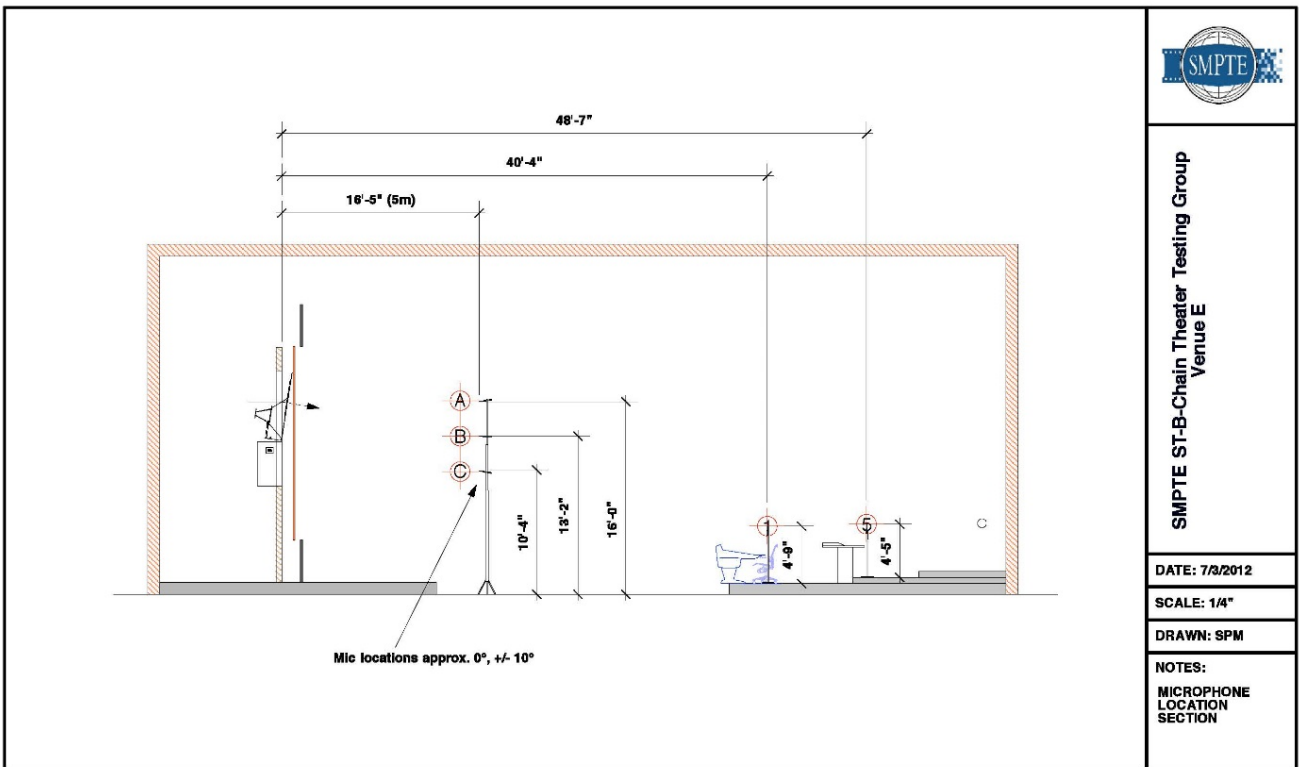
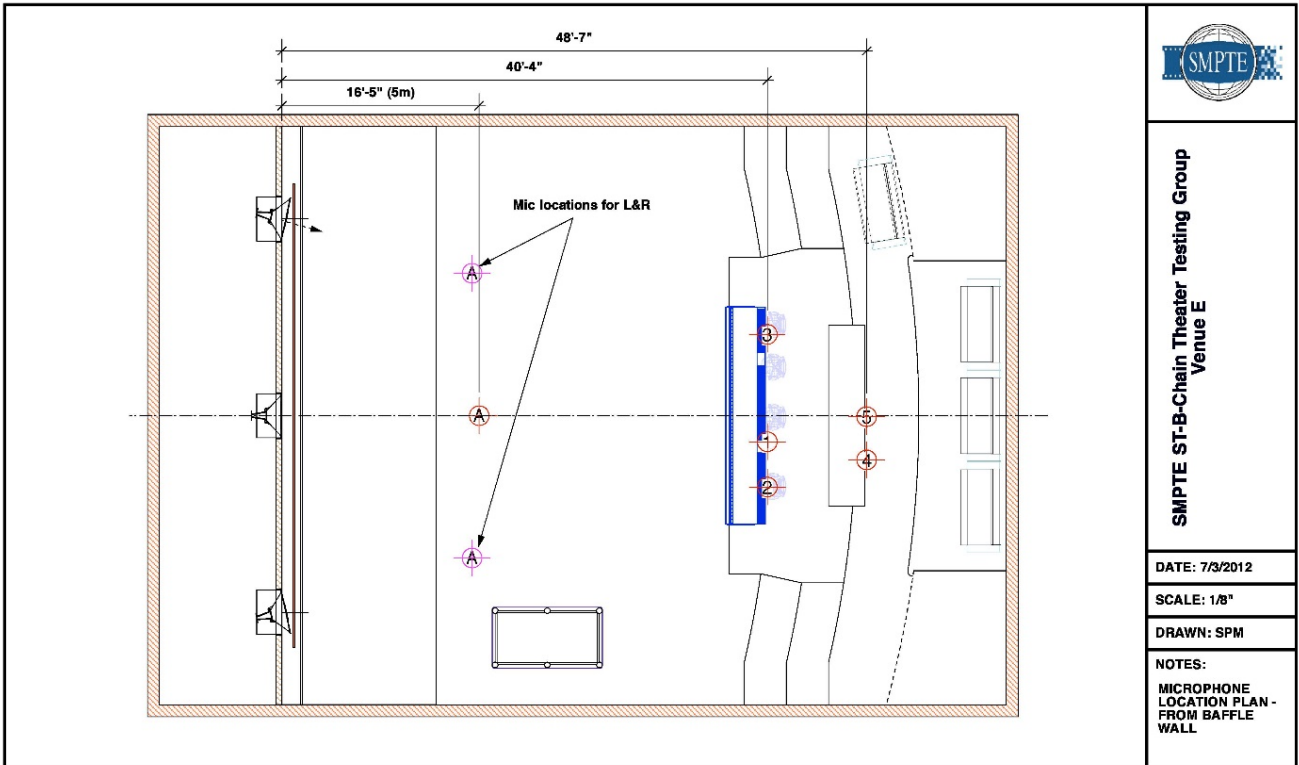

Figure Annex A 3 Elevation view of Microphone Placements in Venue E (dubbing stage), which also shows the positions of the three tree microphones. Note the drawing is not to scale.

A.4 Venue F (Dubbing Stage)

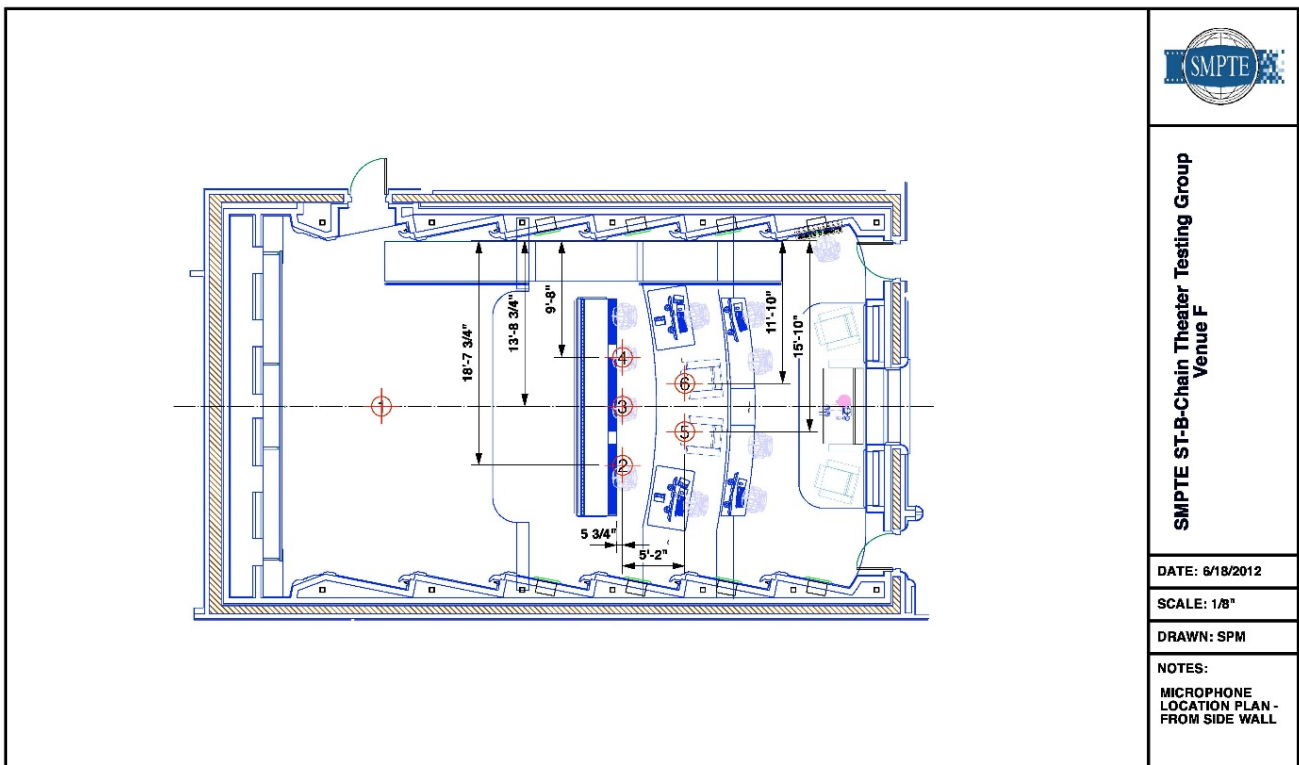
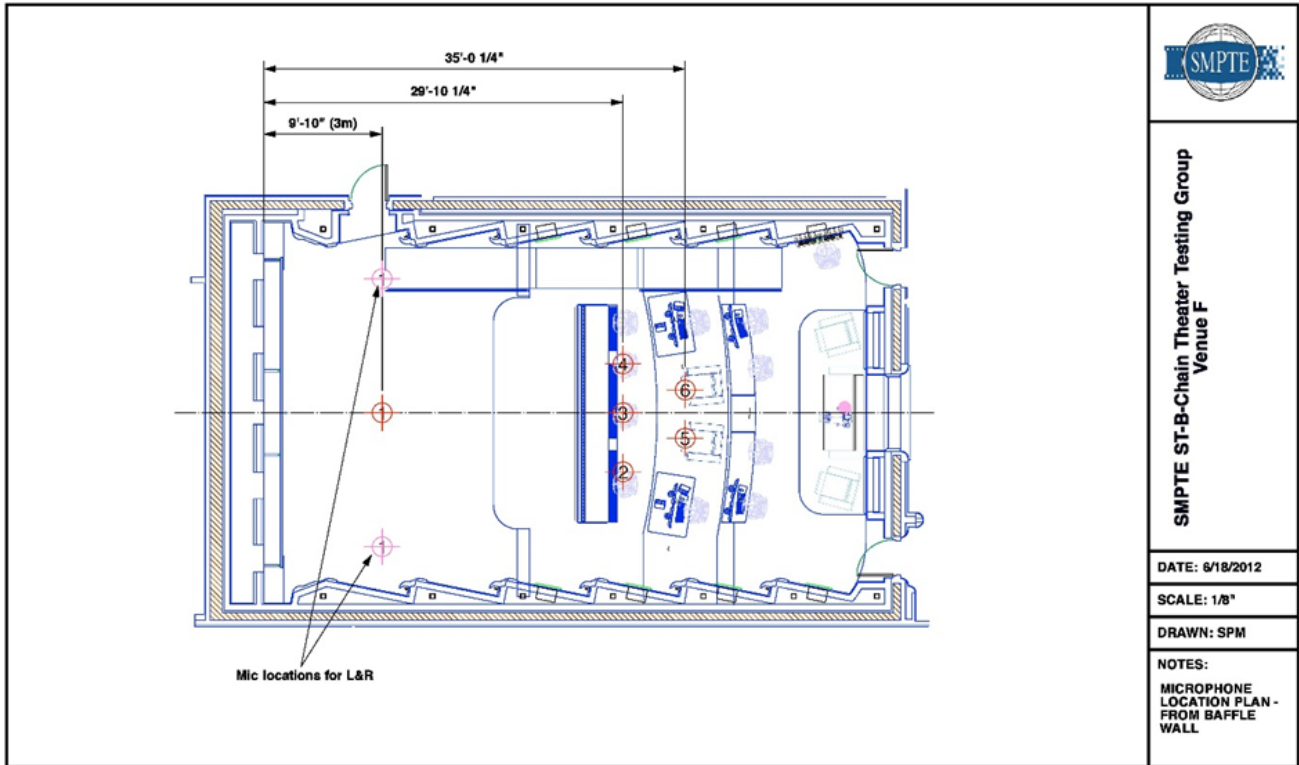

Figure Annex A 4 Plan view of microphone Placements in Venue F (dubbing stage), which also shows the positions of the three tree microphones. Note: the drawing is not to scale.

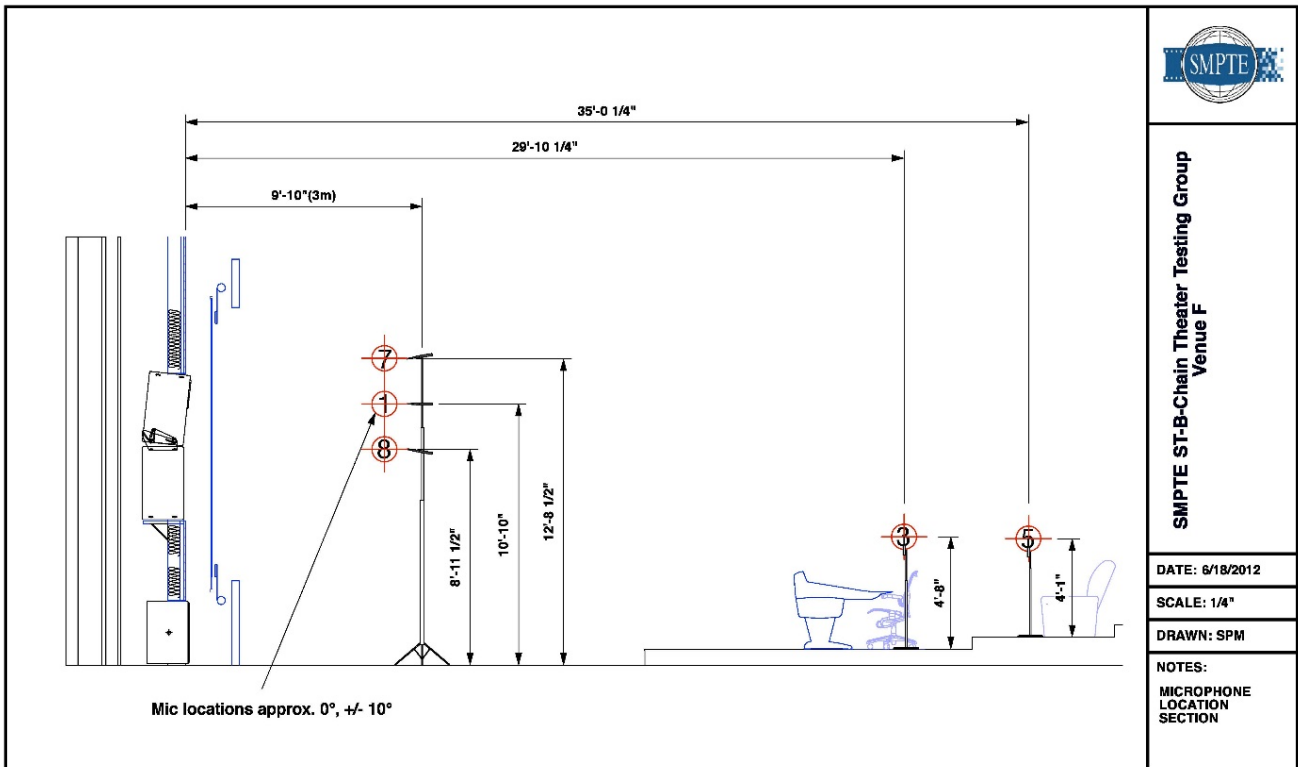

Figure Annex A 5 Elevation view of Microphone Placements in Venue F (dubbing stage) Note the drawing is not to scale.

Annex B BLOCK DIAGRAM OF TEST SETUP

For the testing in the commercial venues the test set-up is shown in Figure B 1, so that a common set of equipment was used in all venues.

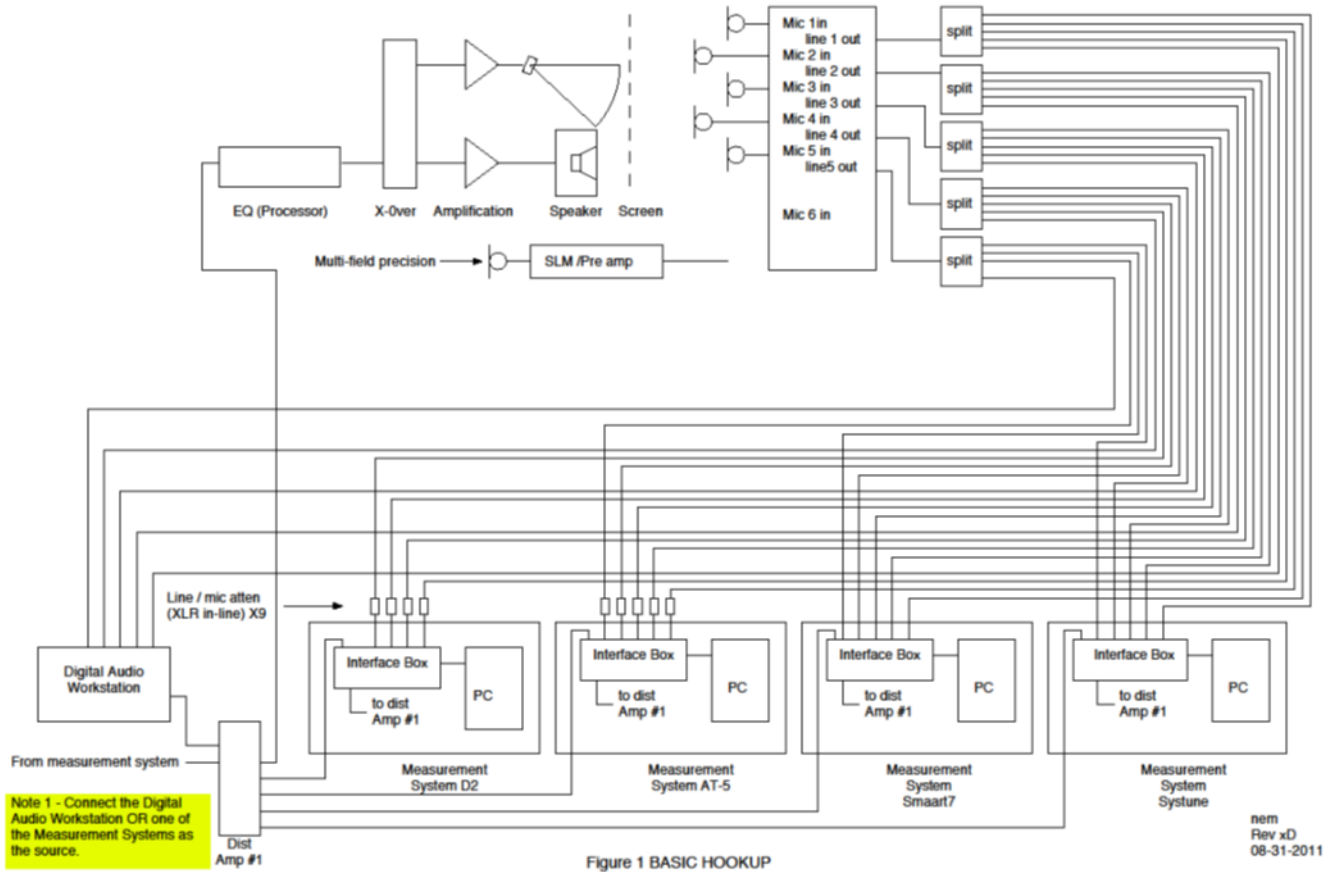

Figure Annex B 1 Schematic Diagram of Theatre Testing Setup



Annex C Matlab Code for Deconvolution

```
% Cross-correlation method with a correction for the magnitude spectrum of the input signal (Input).  
threshold = -60; % threshold below maximum, in dB  
threshold = 10^(threshold / 20); % convert to magnitude  
spectrum1 = fft(Input);  
magnitude1 = abs(spectrum1); %this is also the square root of the auto spectrum  
max_magnitude1 = max(magnitude1); % maximum magnitude value  
below_threshold = magnitude1 < max_magnitude1 * threshold;  
spectrum2 = fft(Output);  
% flatten spectrum1  
spectrum1 = spectrum1 ./ magnitude1;  
% apply the same correction to spectrum2  
spectrum2 = spectrum2 ./ magnitude1;  
% calc cross spectrum of input and output signals (aka cross-correlation) and divide by auto-spectrum  
TF = conj(spectrum1) .* spectrum2;  
TF(below_threshold) = 0;  
IR = ifft(TF);  
normfactor = sum(ifft(spectrum1).^2);  
IR = IR(1:IRlength)./ norm factor; % Truncate to the desired length
```

Annex D MEASUREMENT MICROPHONE TESTS BY THE STUDY GROUP

D.1 Introduction

One of the most important variables in obtaining accurate measurements in cinema spaces is the measurement microphone used. If the microphone(s) do not have a sufficiently wide, accurate pickup pattern and a nearly flat response in the frequency range of interest, the microphone response can produce inaccuracies in the measurement and calibration of the room. A good measurement microphone will have published on-axis and off axis response curves and polar responses for the frequency range of interest. The accuracy of the measurements can be improved by using the microphone's calibration data to adjust the measured response.

The SMPTE B-Chain Study Group Bench Testing Subcommittee determined that this aspect of cinema measurement work deserved special attention. One important consideration is that measurement of cinema spaces, used for both production and exhibition, is necessary for completing the SMPTE B-Chain Study Group's (SG) scope of work. The measurement microphone(s) used by the SG for these measurements must be deemed satisfactory for the task.

As a premier standards organization, laboratory grade microphones (five each) should be acquired for future WG work. The current testing was a way of determining possible alternative candidate microphones that could be used until the laboratory grade microphones are acquired. The SG also desired to document the differences between the tested different microphones as part of its study of "nuisance variables". A microphone comparison test was conducted that was unique in scope and detail and may be the very first of its kind for cinema applications.

D.2 The Measurement Microphone Comparison Test

Six microphone models were compared to a laboratory grade reference microphone to determine which models may be acceptable for the SG work and to document the variation the candidate microphones have from the reference. A Bruel & Kjaer Type 4961 Multi-field microphone was used as the reference. The microphones were measured using laboratory reference wideband pink noise (from Hollywood Edge TMH Digital Audio Test and Measurement Disc Series) played alternately through the center, left surround, and subwoofer speakers of a reference screening room. Each microphone was tested at several angles of incidence. In this way, the suitability of each microphone for different measurement situations could be compared.

Table D.1 - Microphones Measured in the Comparison

Bruel & Kjaer Type 4961	http://www.bksv.com/products/transducers/acoustic/microphones/microphone-preamplifier-combinations/4961.aspx
Audix TM-1	http://www.audixusa.com/docs_12/units/TM1_-_TM1_PLUS_.shtml
Beyer MM-1 (3/8")	http://north-america.beyerdynamic.com/shop/mm-1.html
Bruel & Kjaer 4189 (1/2")	http://www.bksv.com/Products/transducers/acoustic/microphones/microphone-cartridges/4189.aspx
DPA 4007	http://www.dpamicrophones.com/en/products.aspx?c=item&category=143&item=24012
Earthworks TC30	http://www.earthworksaudio.com/microphones/time-coherent-series/tc30/
iSEMcon EMX-7150 (1/4")	http://www.isemcon.com/datasheets/EMM7150-US-2page.pdf

D.3 Measurement Methodology

The microphones were measured on January 10, 2012, in a reference screening room. Two microphones were nominal ½" diameter types, three microphones were ¼" diameter types, and one was 9 mm type.

The measurement location in the room was selected on the room centerline, approximately 2/3 back from the screen. The first microphone, the reference, to be measured was put in position. Using a "construction-leveling" laser a horizontal plane was established at the center of the microphone capsule. Then a "pointing" laser was placed below the microphone with its beam perpendicular to the horizontal laser plane striking the front of the capsule. The lasers were secured and were not and did not move for the duration of the testing. Subsequent microphones were placed with their capsules within one-half the capsule diameter of the first microphone's location.

Using a digital inclinometer to set microphone orientation relative to the screen, measurements were taken at 0 (towards the center speaker), 22.5, 45, and 90-degree (straight up) orientations for all microphones, except for the two ISO Type 1 microphones, where measurements were taken at 0, 45, and 90-degree orientations.

Transfer function magnitude measurements were taken using the reference wideband pink noise using the Systune and Smaart 7 measurement programs.

D.4 Conclusions

In the event that laboratory grade microphones are not available the ¼" types and the 9 mm type microphones measured may be used noting the variations from the reference for each source type measured.

The data indicates that ½" microphone types should not be used for equalization work. Please see the 90 degree off-axis response for the two ½" microphones compared to their on-axis response, and to that for the reference microphone, in Figures 18 and 27. See Nuisance Variables Attachment B for a detailed description.

D.5 Measurement Data

The measured microphone data is summarized in Table D.2. The response (using Smaart 7) for the microphones are overlaid for the center screen and sub-woofer channels by orientation (0 degrees and 90 degrees) in Figures D.1 to D.4. The responses for all microphones are overlaid for the surround channel by orientation (90 degrees) in figure D.5. These responses are presented with 1/24th octave smoothing.

Comparison of a microphone's response at several orientations (using Systune v1.2.2) to the reference microphone response at 0 degrees is summarized in Figures D.6 – D.17 and Figures D.21– D.26. The reference microphone responses are presented in Figure D.18 – D.20. These responses are presented with 1/3 octave smoothing.

For Figures D.1 – D.17 and Figures D.21 – D.26 the reference microphones response was adjusted to match the sample microphones response at 1000 Hz for the center and surround left measurements and at 100 Hz for the sub-woofer measurements.

The accuracy of the measurements can be improved by using the microphone's calibration data to adjust the measured response.

Table D.2 – Microphone Measurement Summary

<u>Source</u>	<u>Microphone Orientation (degrees)</u>	<u>Frequency range (Hz)</u>	<u>Amplitude Variation (+/- dB)</u>	<u>Figure number</u>	<u>Notes</u>
Screen center	0 0	20 – 8,000 20 – 16,000	1.0 1.5	D.1	All seven microphones.
Screen center	90 90	20 – 6,000 20 – 16,000	1.0 1.6	D.2	“Variation” excludes two ½” capsule microphones shown in figure and one microphone that experienced a phantom power anomaly (See Nuisance Variables Attachment B for recommendation not to use ½” microphones for equalization.)
Sub-woofer	0 0	20 – 100 20 – 120	0.5 0.6	D.3	All seven microphones
Sub-woofer	90 90	20 – 125 30 – 125	0.75 0.5	D.4	Excluding microphone with phantom power anomaly
Surround left	90	30 – 8,000 30 – 16,000	1.0 1.5	D.5	Five microphones (excludes ½” capsules)

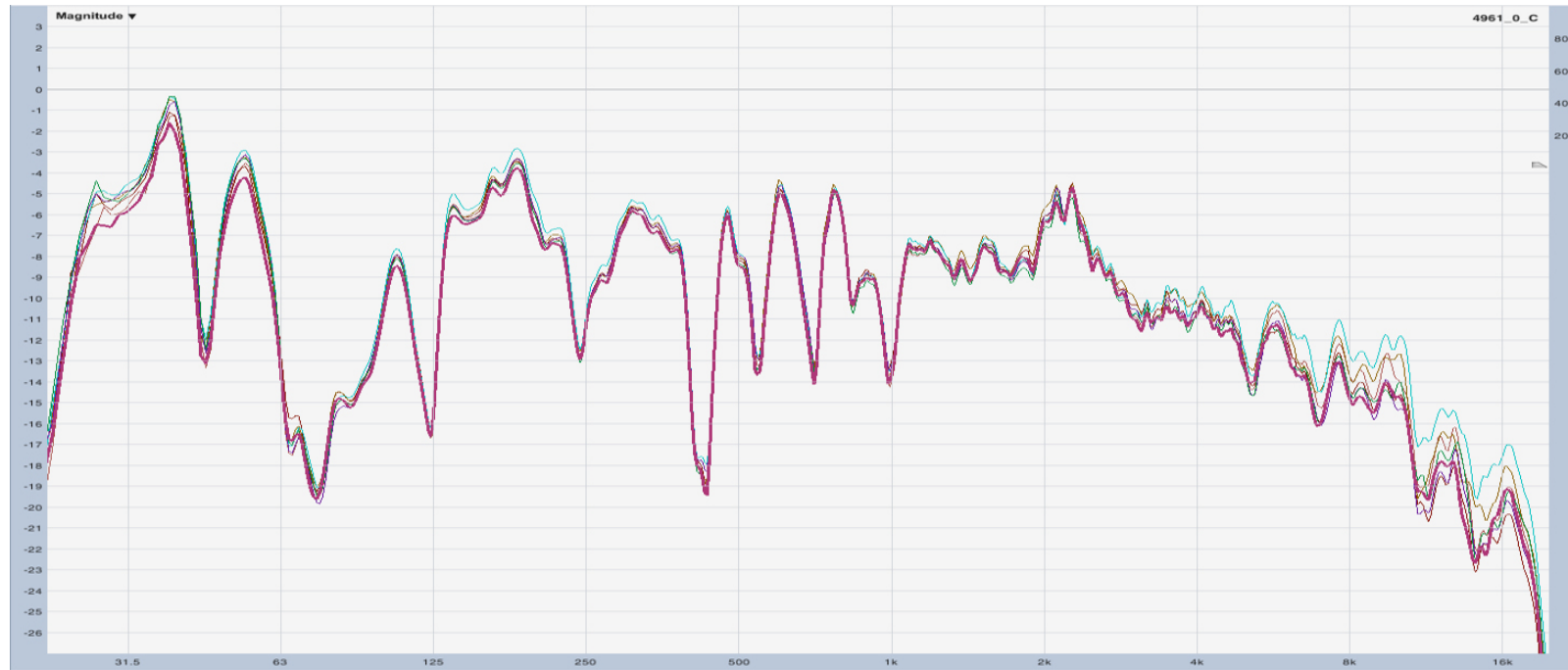

**Figure D.1 – Microphone Comparison - Screen Center - 0 degrees - 1/24 octave smoothing
(Reference Screening Room)**

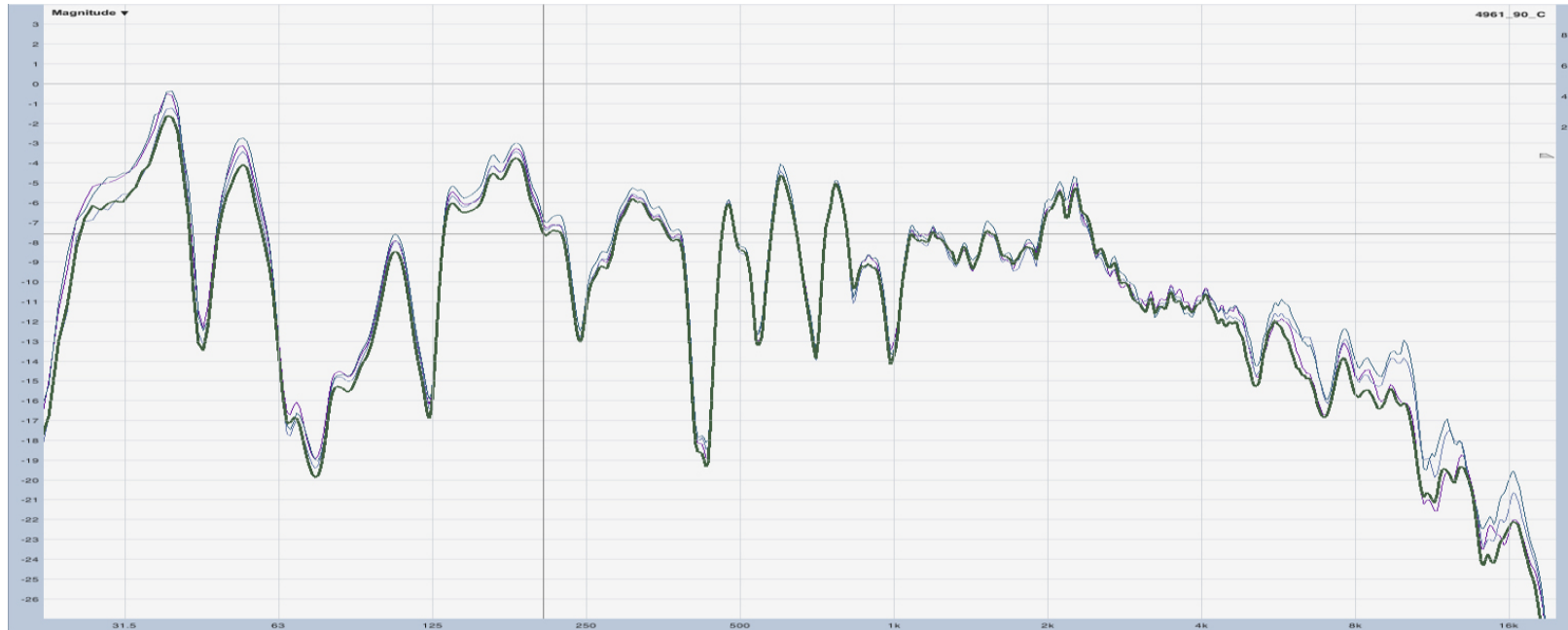

**Figure D. 2 – Microphone Comparison - Screen Center - 90 degrees - 1/24 octave smoothing
(Reference Screening Room)**



**Figure D. 3 – Microphone Comparison - Sub-woofer - 0 degrees - 1/24 octave smoothing
(Reference Screening Room)**



**Figure D. 4 – Microphone Comparison - Sub-woofer - 90 degrees - 1/24 octave smoothing
(Reference Screening Room)**

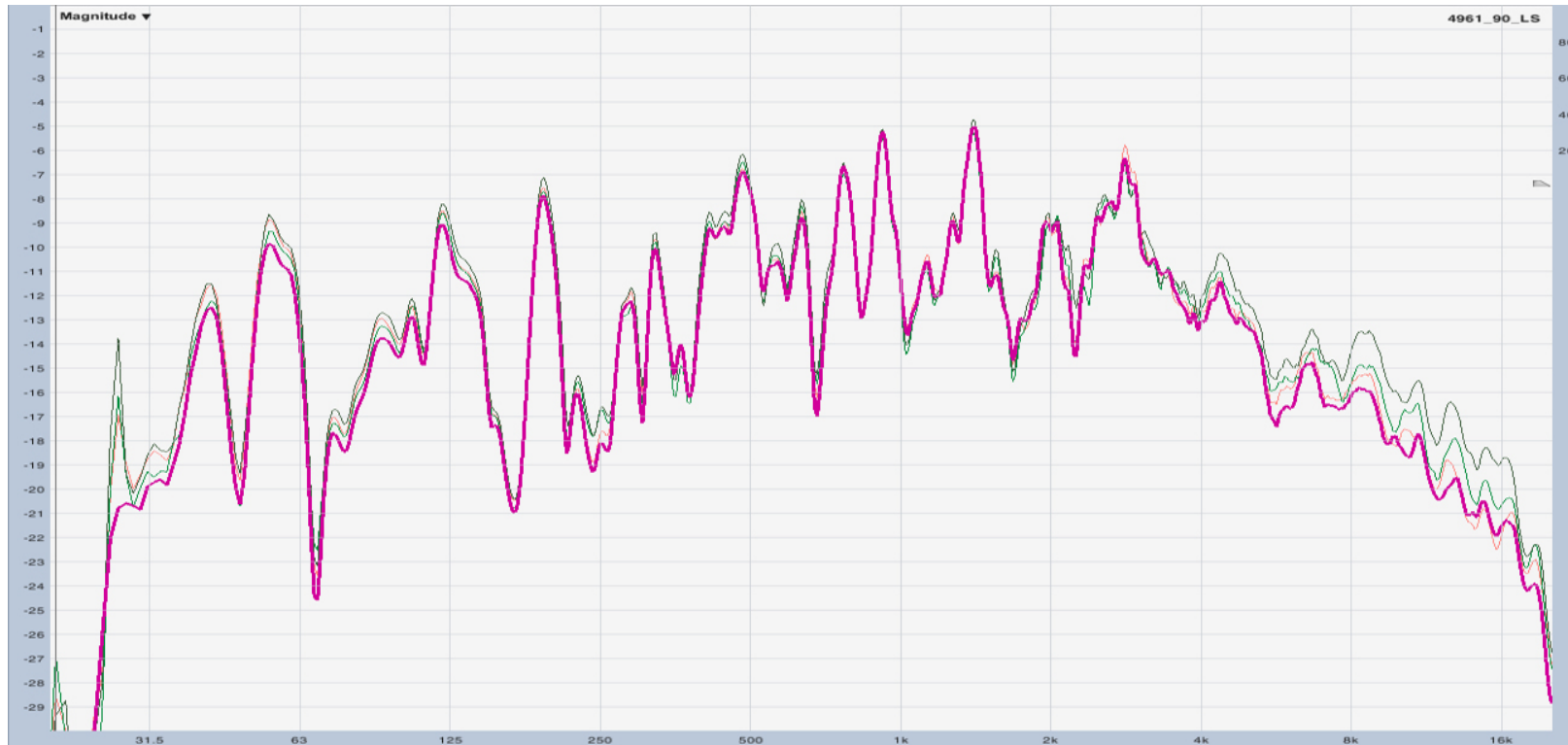

**Figure D. 5 – Microphone Comparison - Left Surround - 90 degrees - 1/24 octave smoothing
(Reference Screening Room)**

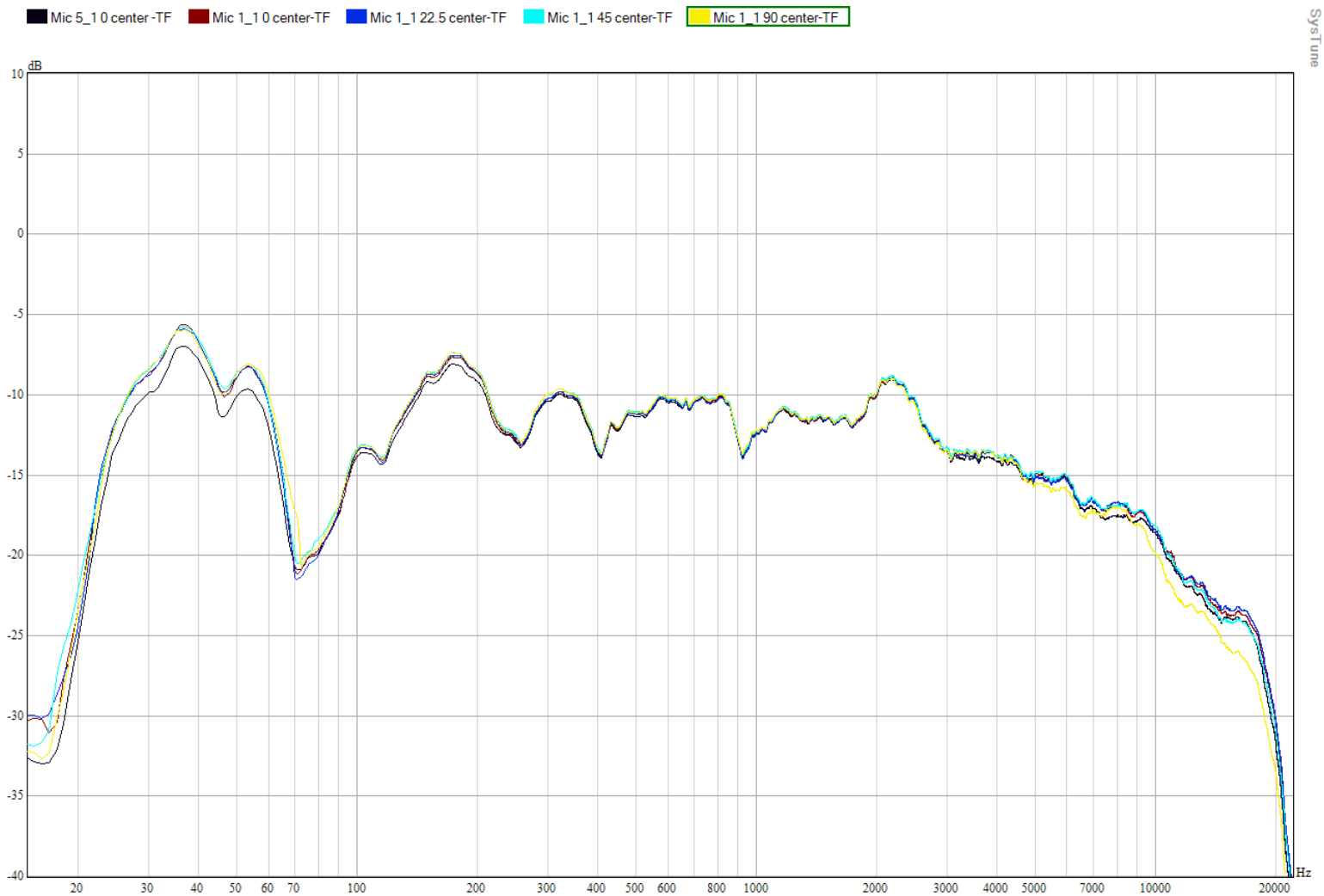

**Figure D. 6 – Sample #1 response – center channel – 0, 22.5, 45, and 90 degrees compared to reference microphone – center channel - 0 degrees
 1/3 octave smoothing
 (Reference Screening Room)**

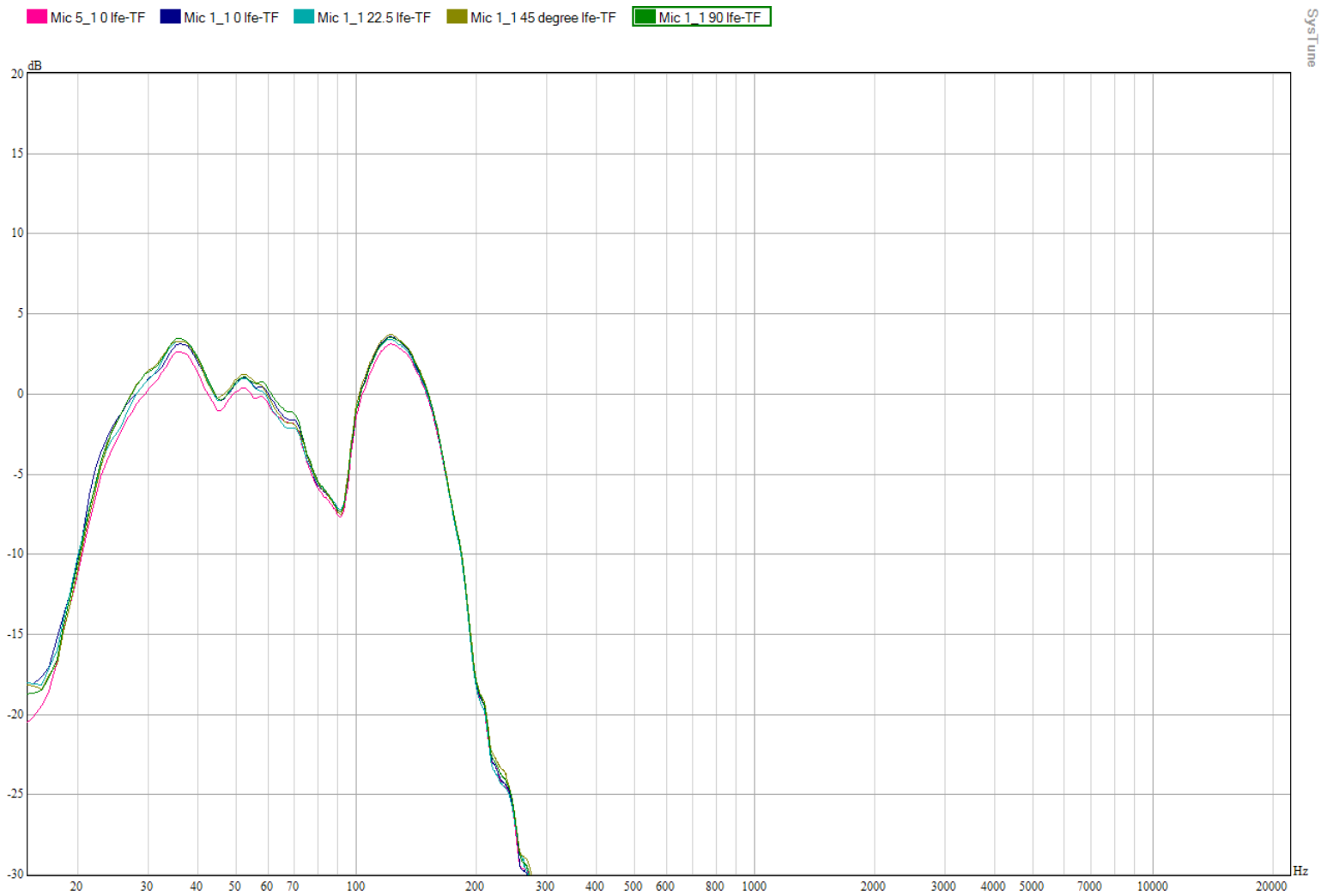

**Figure D. 7 – Sample #1 response – sub-woofer channel – 0, 22.5, 45, and 90 degrees compared to reference microphone – sub-woofer channel - 0 degrees
 1/3 octave smoothing
 (Reference Screening Room)**

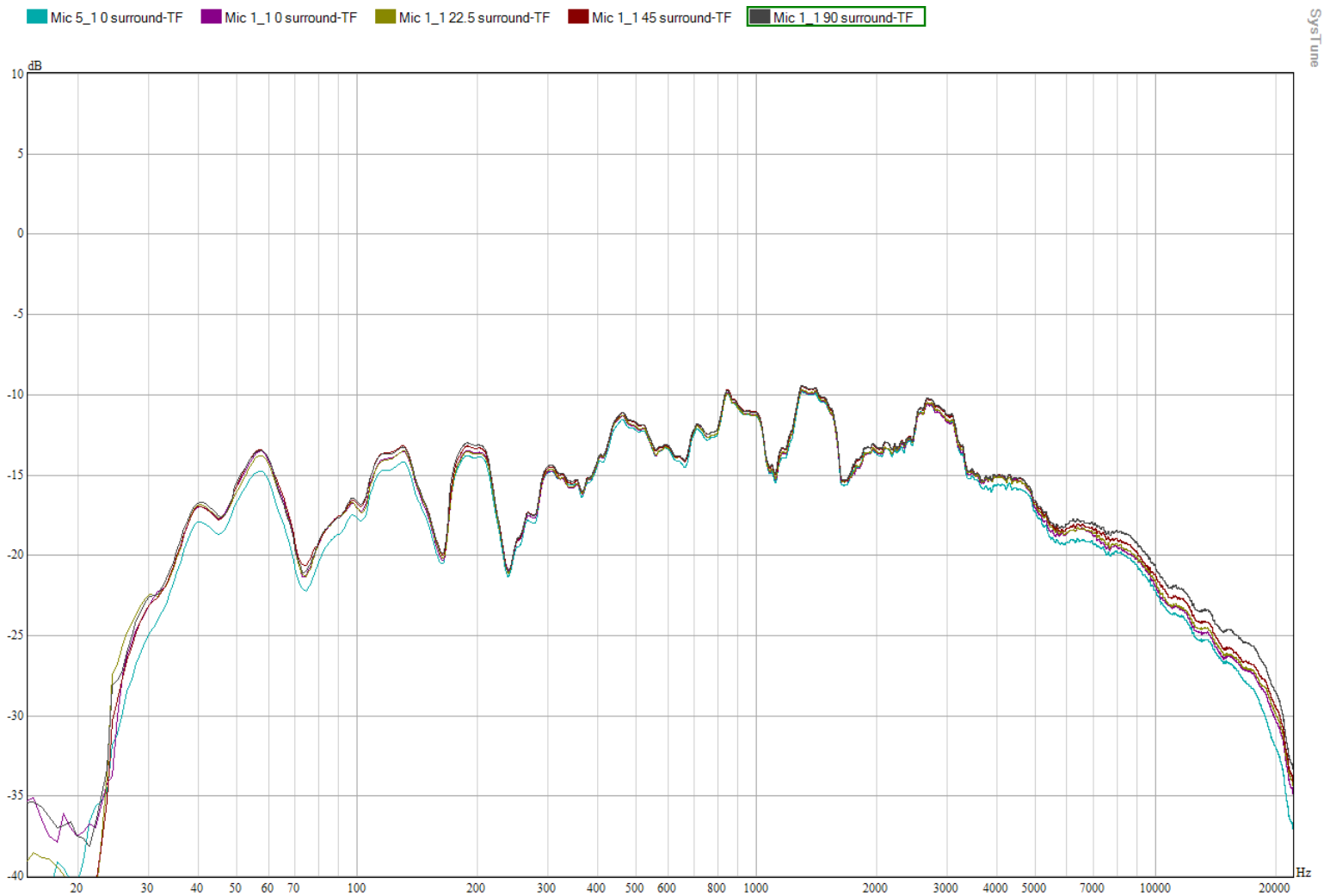

**Figure D. 8 – Sample #1 response – surround left channel – 0, 22.5, 45, and 90 degrees compared to reference microphone – surround left channel - 0 degrees
 1/3 octave smoothing
 (Reference Screening Room)**

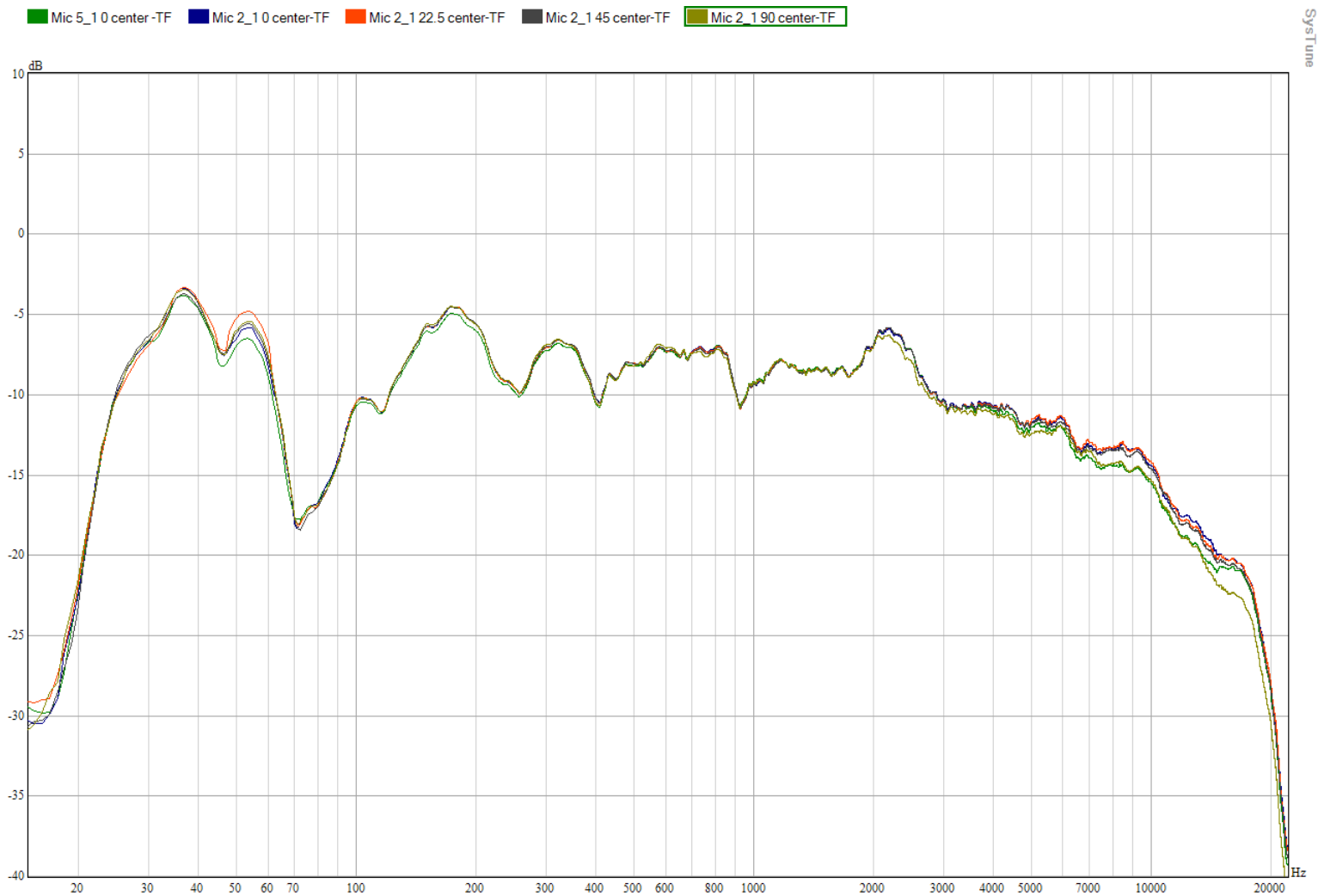

**Figure D. 9 – Sample #2 response – center channel – 0, 22.5, 45, and 90 degrees
 compared to reference microphone - center channel - 0 degrees
 1/3 octave smoothing
 (Reference Screening Room)**

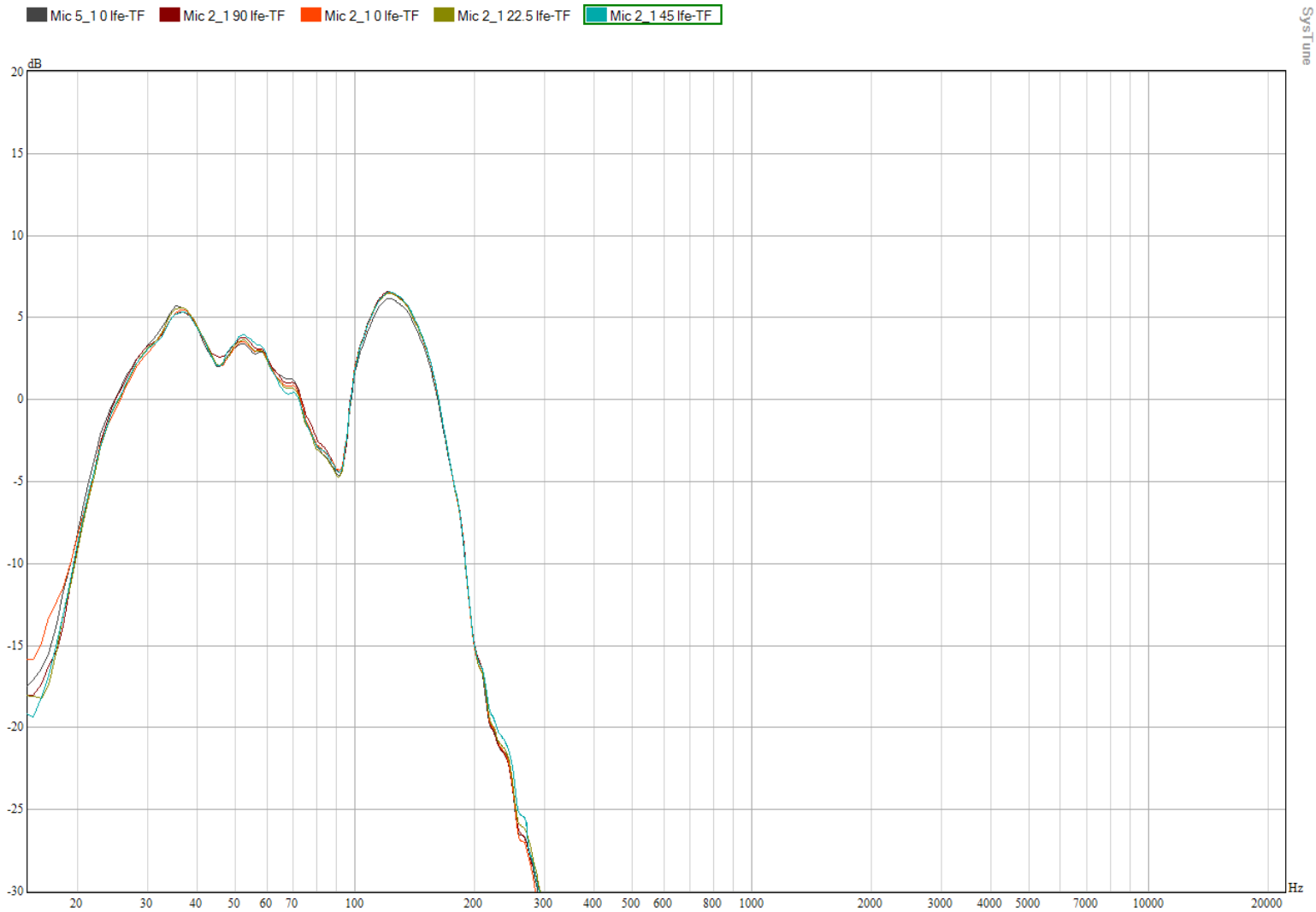
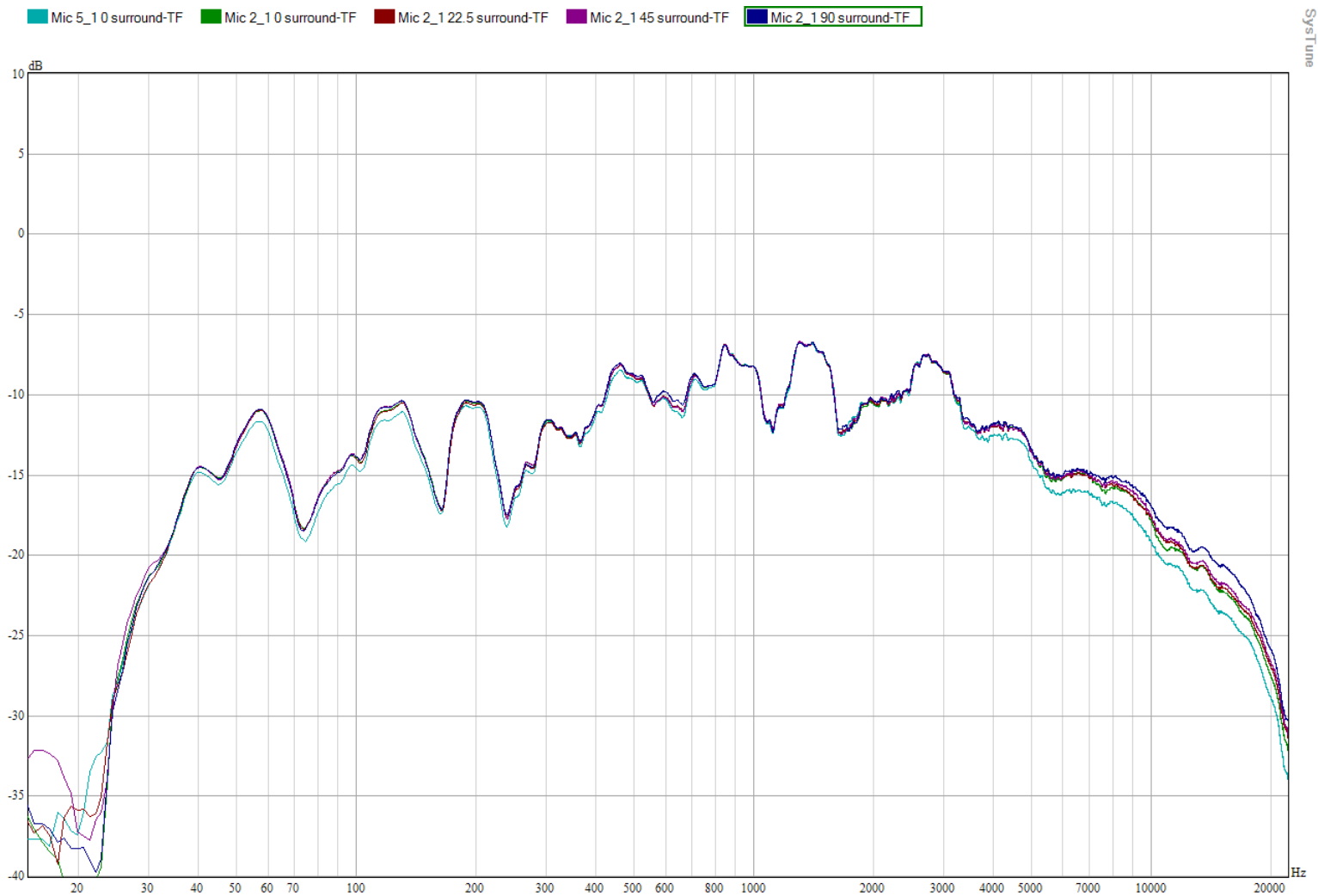

Figure D. 10 – Sample #2 response – sub-woofer channel – 0, 22.5, 45, and 90 degrees compared to reference microphone – sub-woofer channel - 0 degrees (1/3 octave smoothing) (Reference Screening Room)



**Figure D. 11 – Sample #2 response – surround left channel – 0, 22.5, 45, and 90 degrees compared to reference microphone – surround left channel - 0 degrees
 1/3 octave smoothing
 (Reference Screening Room)**

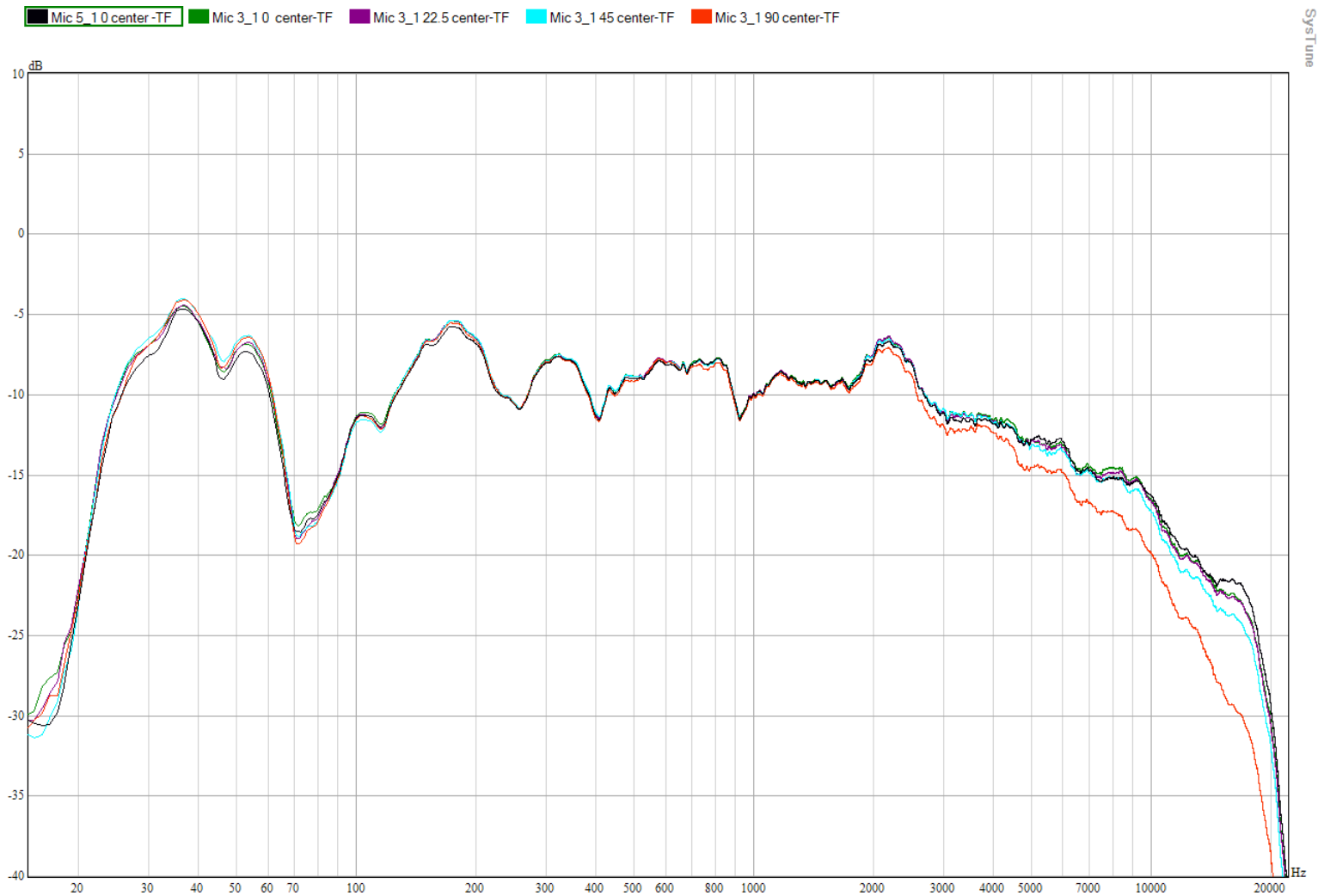

Figure D. 12 – Sample #3 response – center channel – 0, 22.5, 45, and 90 degrees compared to reference microphone - center channel - 0 degrees (1/3 octave smoothing (Reference Screening Room))

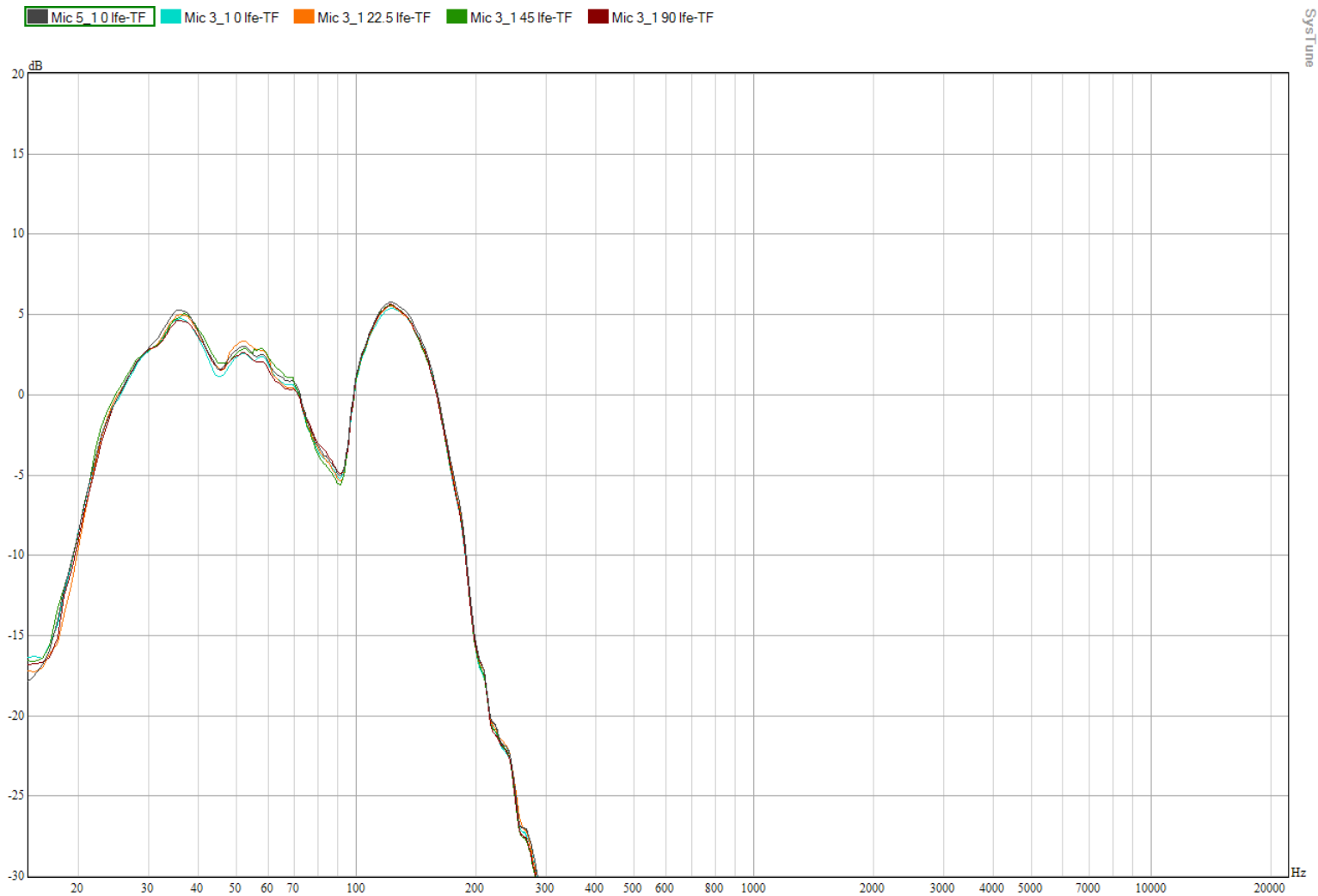
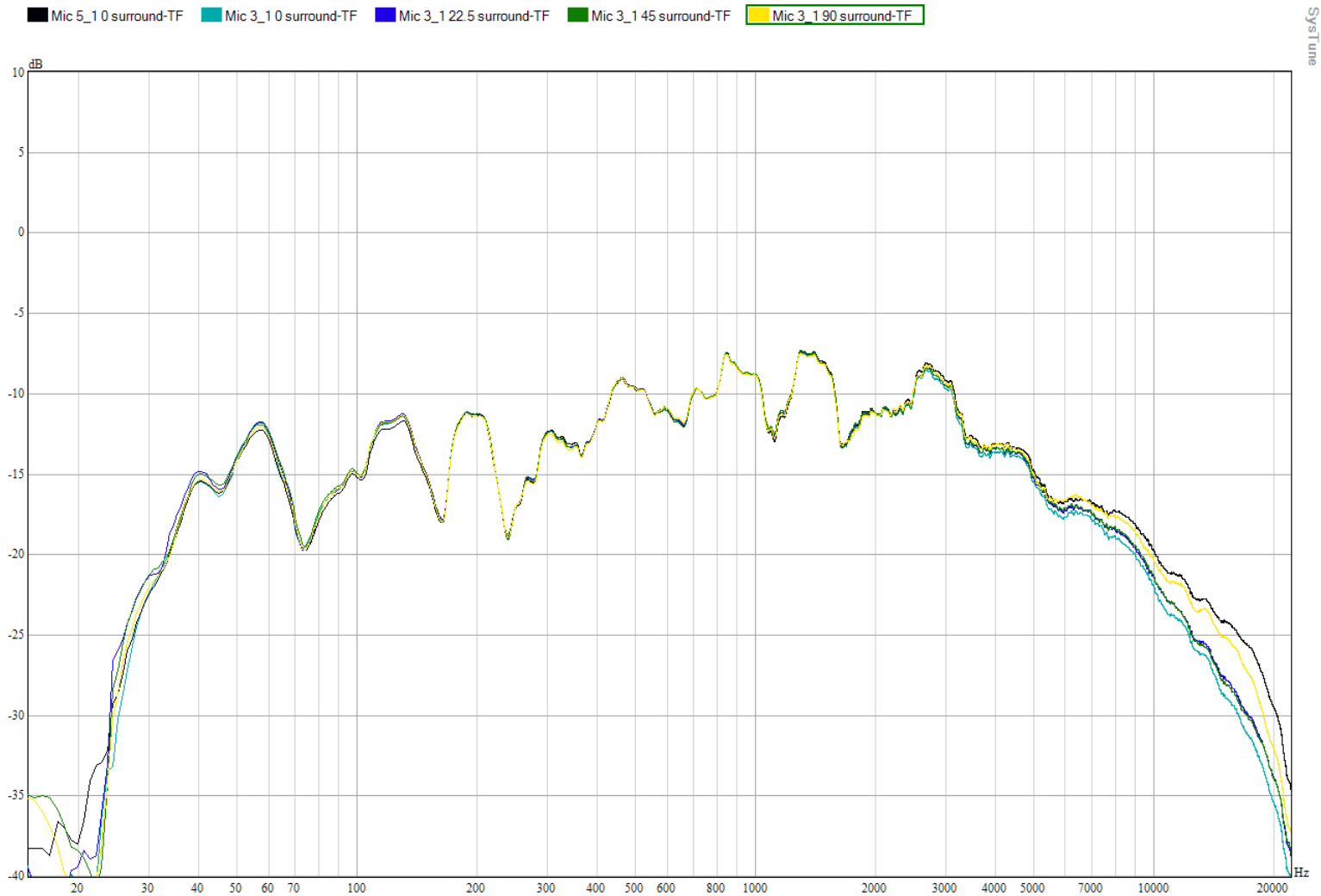

Figure D. 13 - Sample #3 response - sub-woofer channel - 0, 22.5, 45, and 90 degrees compared to reference microphone - sub-woofer channel - 0 degrees (1/3 octave smoothing) (Reference Screening Room)



**Figure D. 14 – Sample #3 response – surround left channel – 0, 22.5, 45, and 90 degrees compared to reference microphone – surround left channel - 0 degrees
 1/3 octave smoothing
 (Reference Screening Room)**

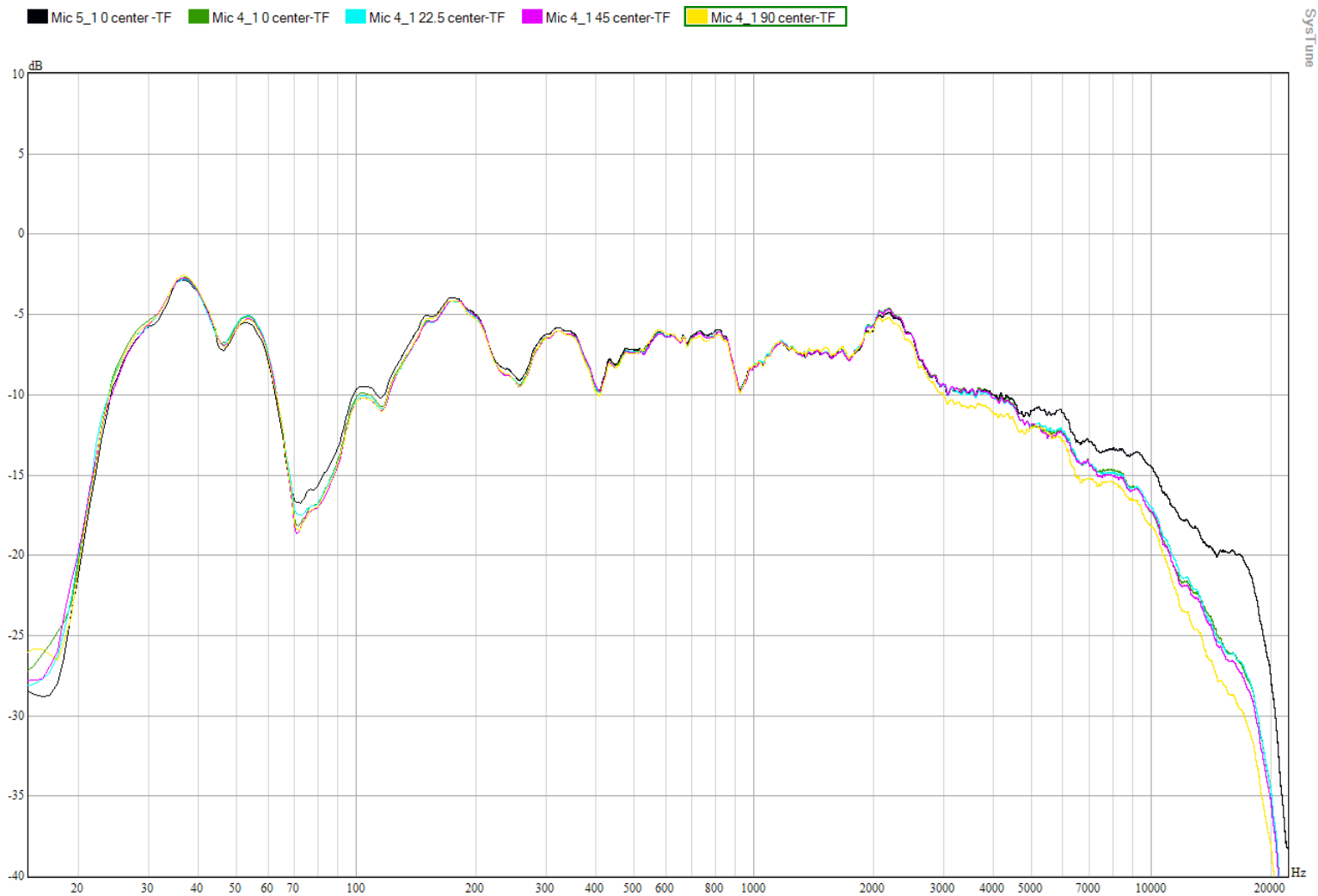
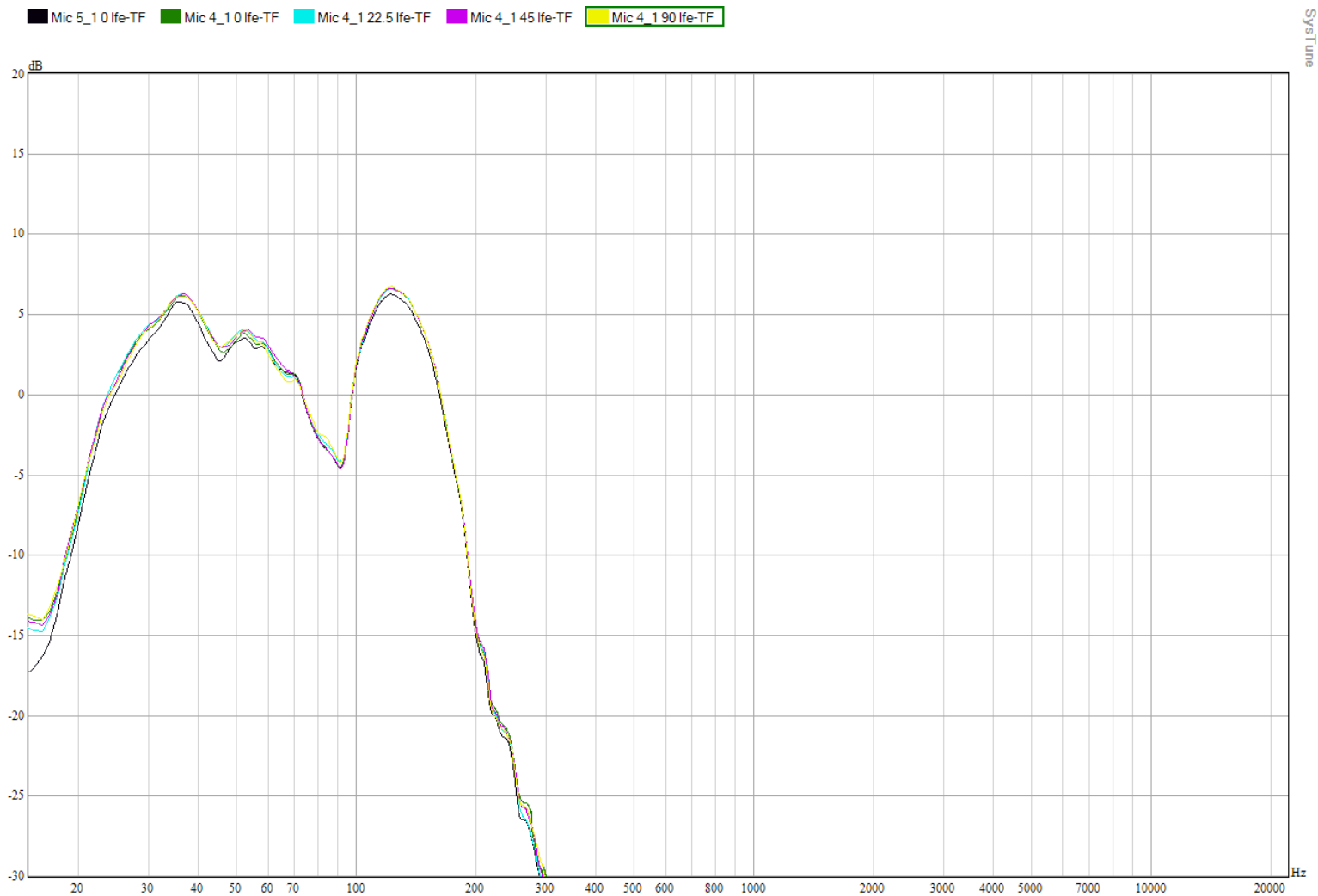
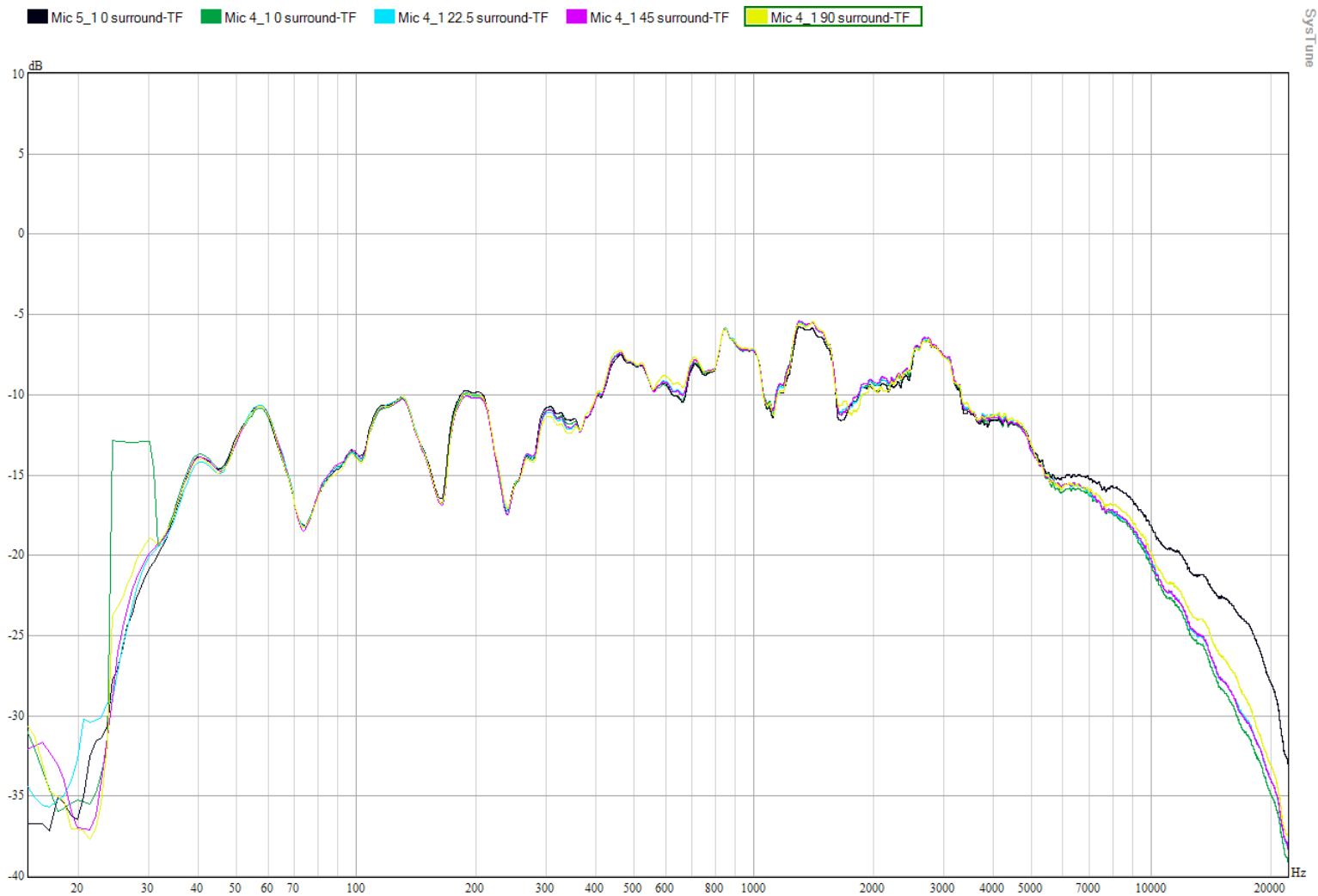

Figure D. 15 – Sample #4 response – center channel – 0, 22.5, 45, and 90 degrees compared to reference microphone - center channel - 0 degrees (1/3 octave smoothing) (Reference Screening Room)



**Figure D. 16 – Sample #4 response – sub-woofer channel – 0, 22.5, 45, and 90 degrees
compared to reference microphone – sub-woofer channel - 0 degrees
(1/3 octave smoothing)
(Reference Screening Room)**



**Figure D. 17 – Sample #4 response – surround left channel – 0, 22.5, 45, and 90 degrees compared to reference microphone – surround left channel - 0 degrees
 1/3 octave smoothing
 (Reference Screening Room)**

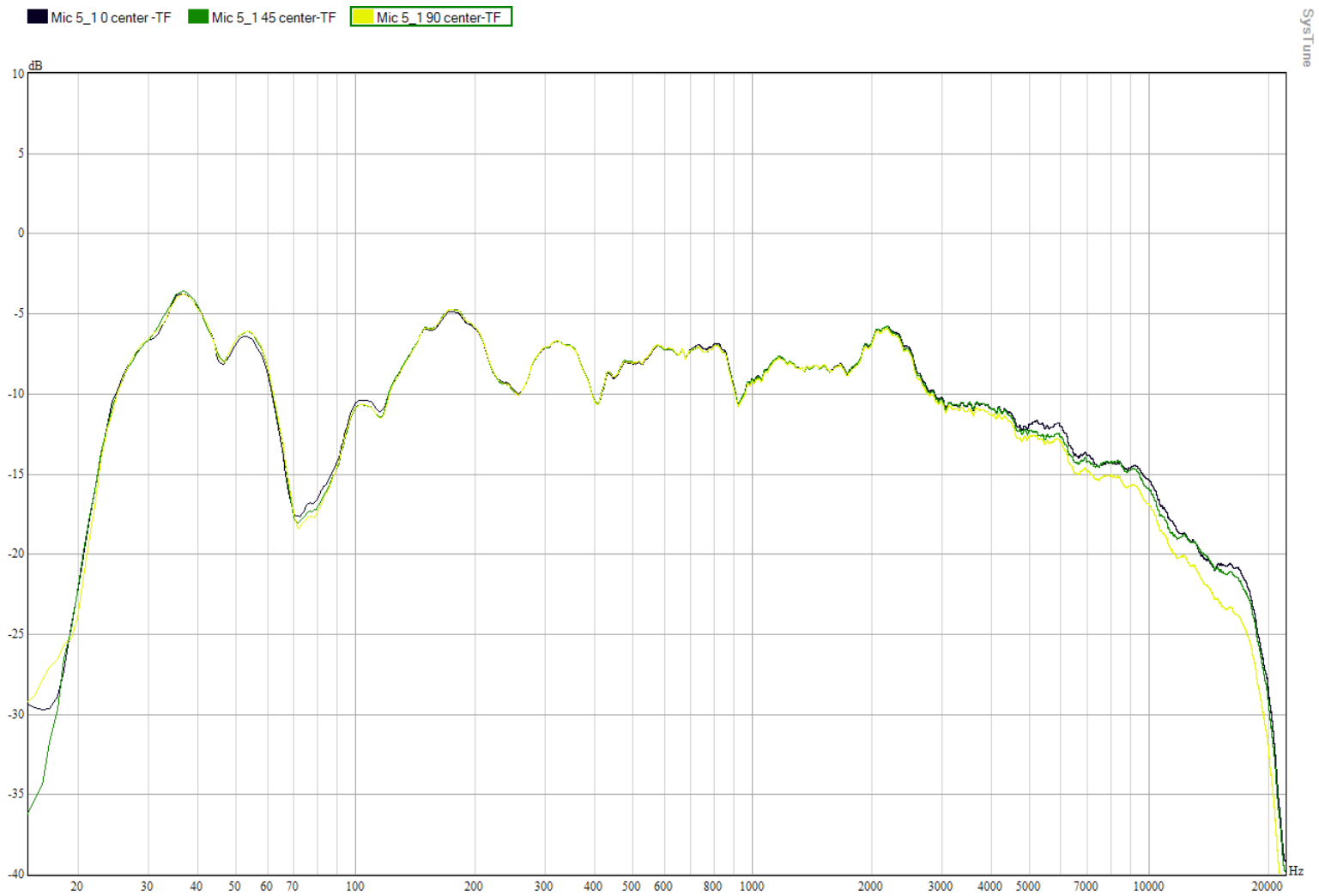

**Figure D. 18 – Reference microphone response - center channel - 0, 45, 90 degrees
 1/3 octave smoothing
 (Reference Screening Room)**

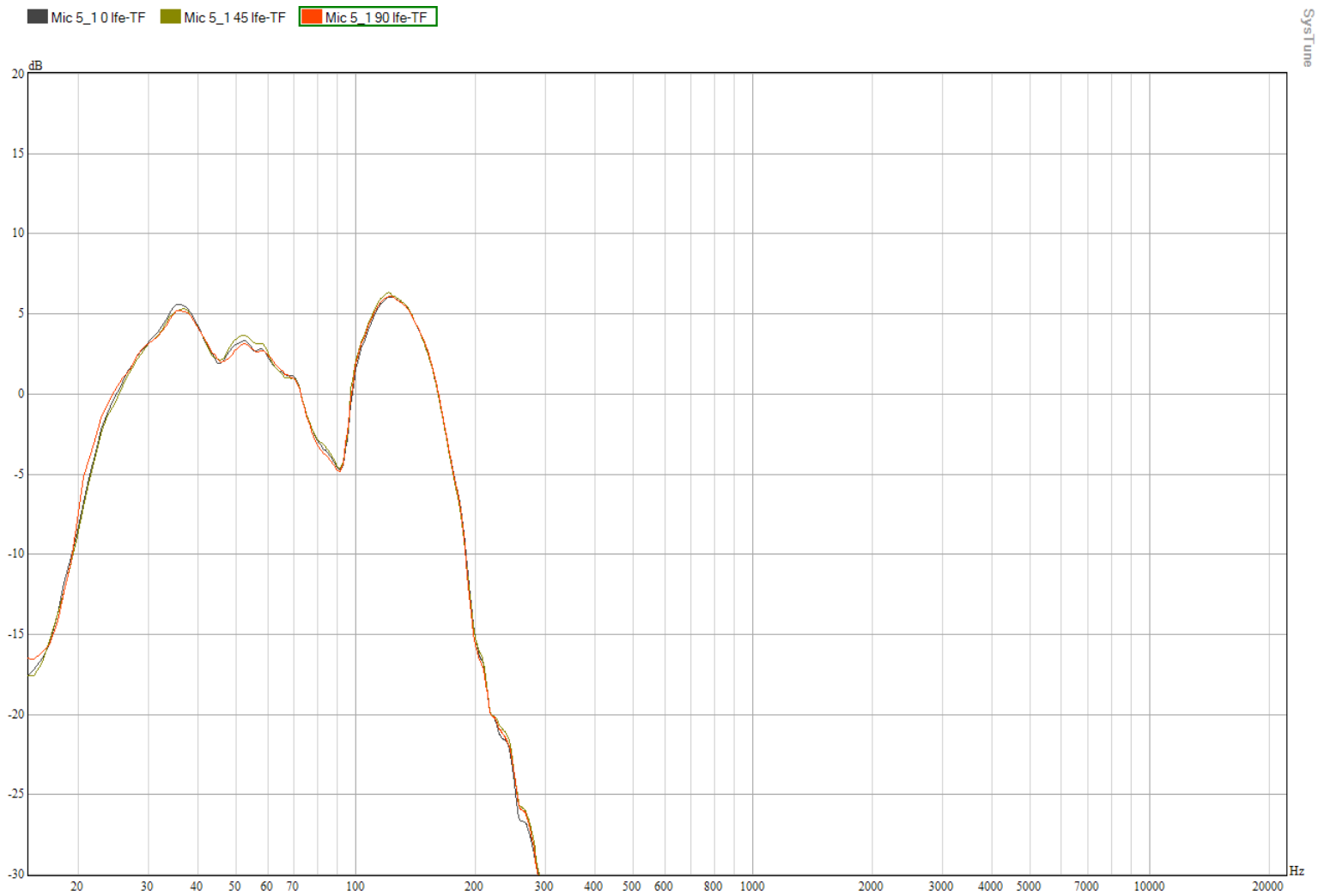

**Figure D. 19 – Reference microphone response – sub-woofer channel - 0, 45, 90 degrees
 1/3 octave smoothing
 (Reference Screening Room)**

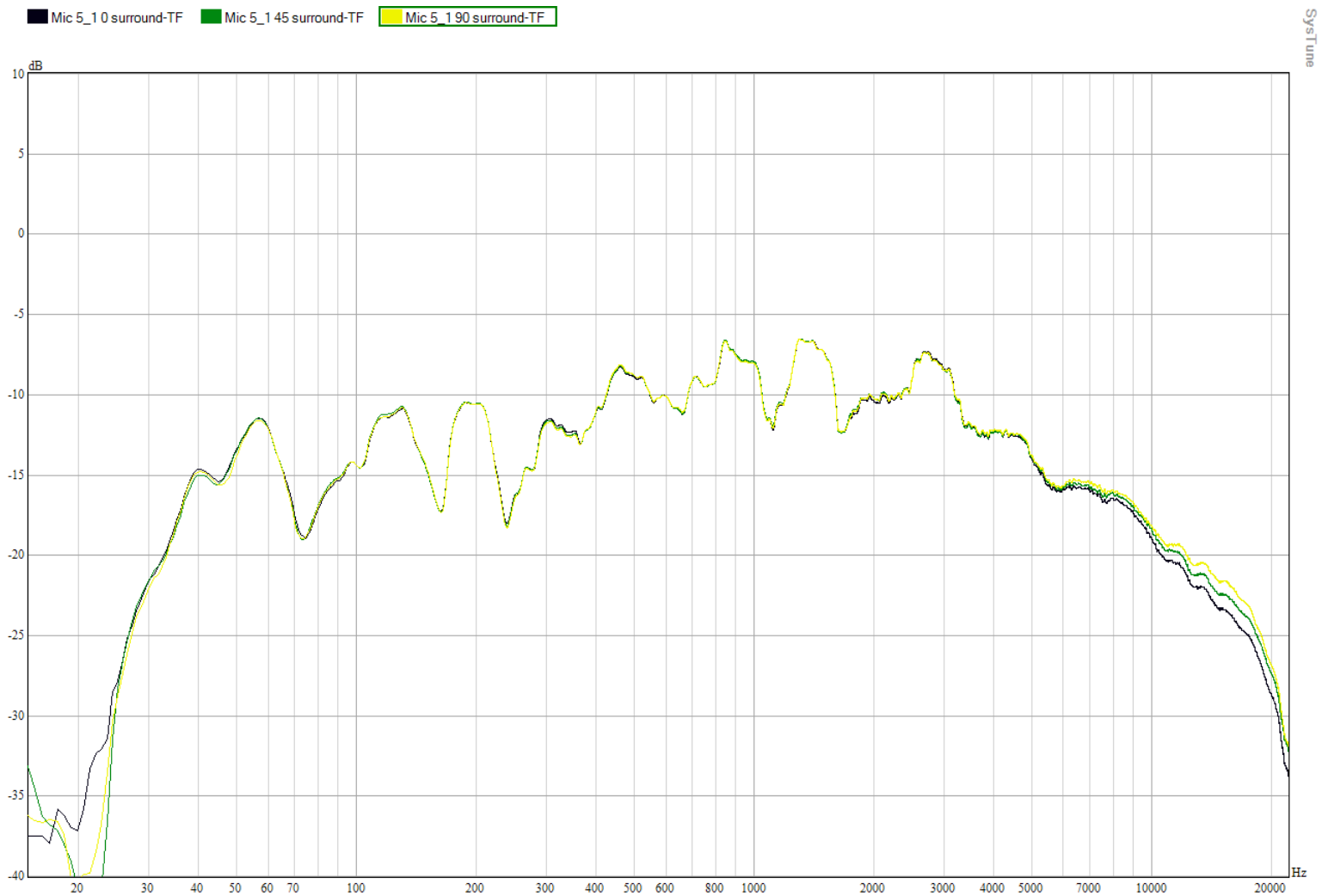

**Figure D. 20 – Reference microphone response – surround channel - 0, 45, 90 degrees
 1/3 octave smoothing
 (Reference Screening Room)**

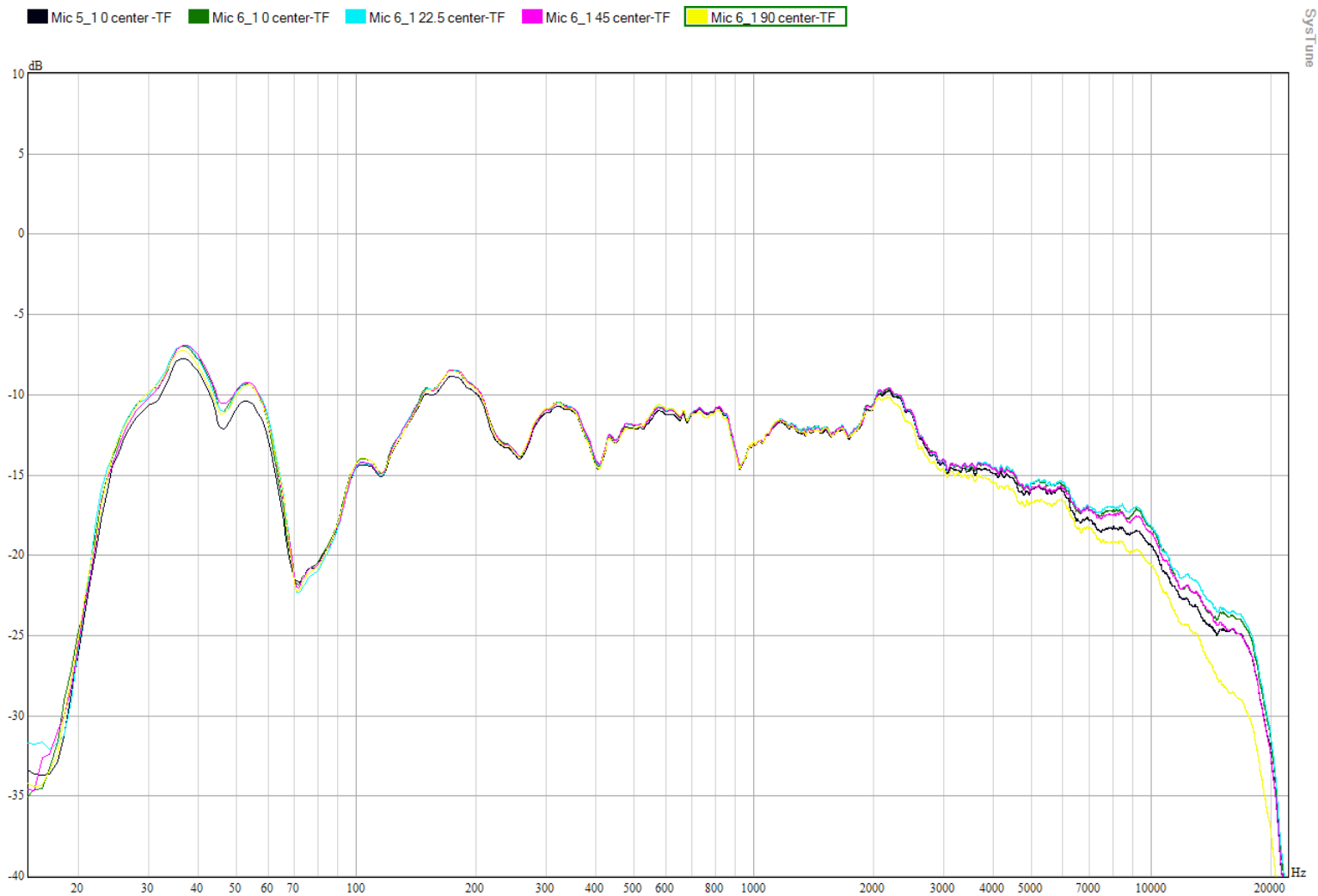

Figure D. 21 – Sample #6 response – center channel – 0, 22.5, 45, and 90 degrees compared to reference microphone - center channel - 0 degrees (1/3 octave smoothing (Reference Screening Room))

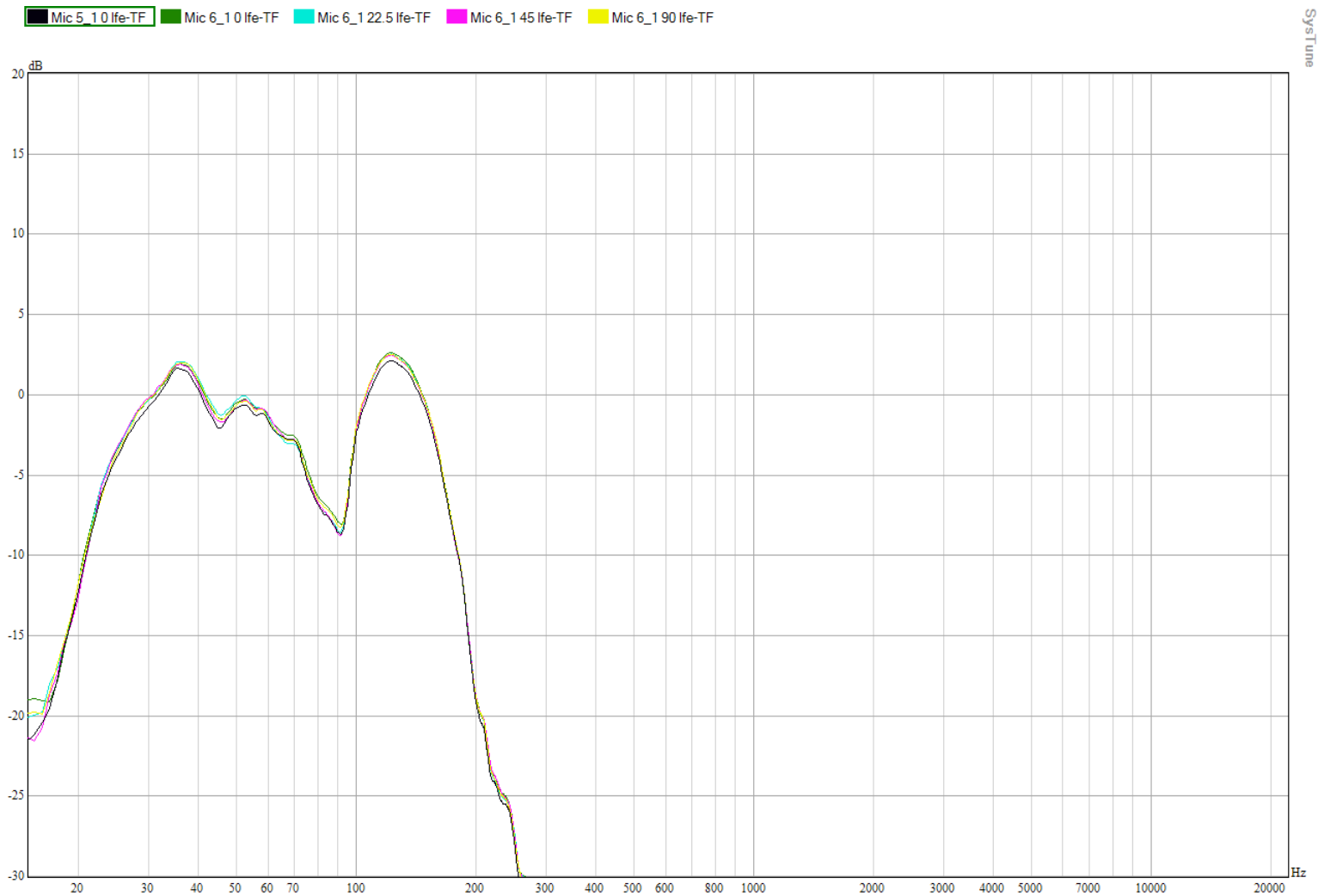
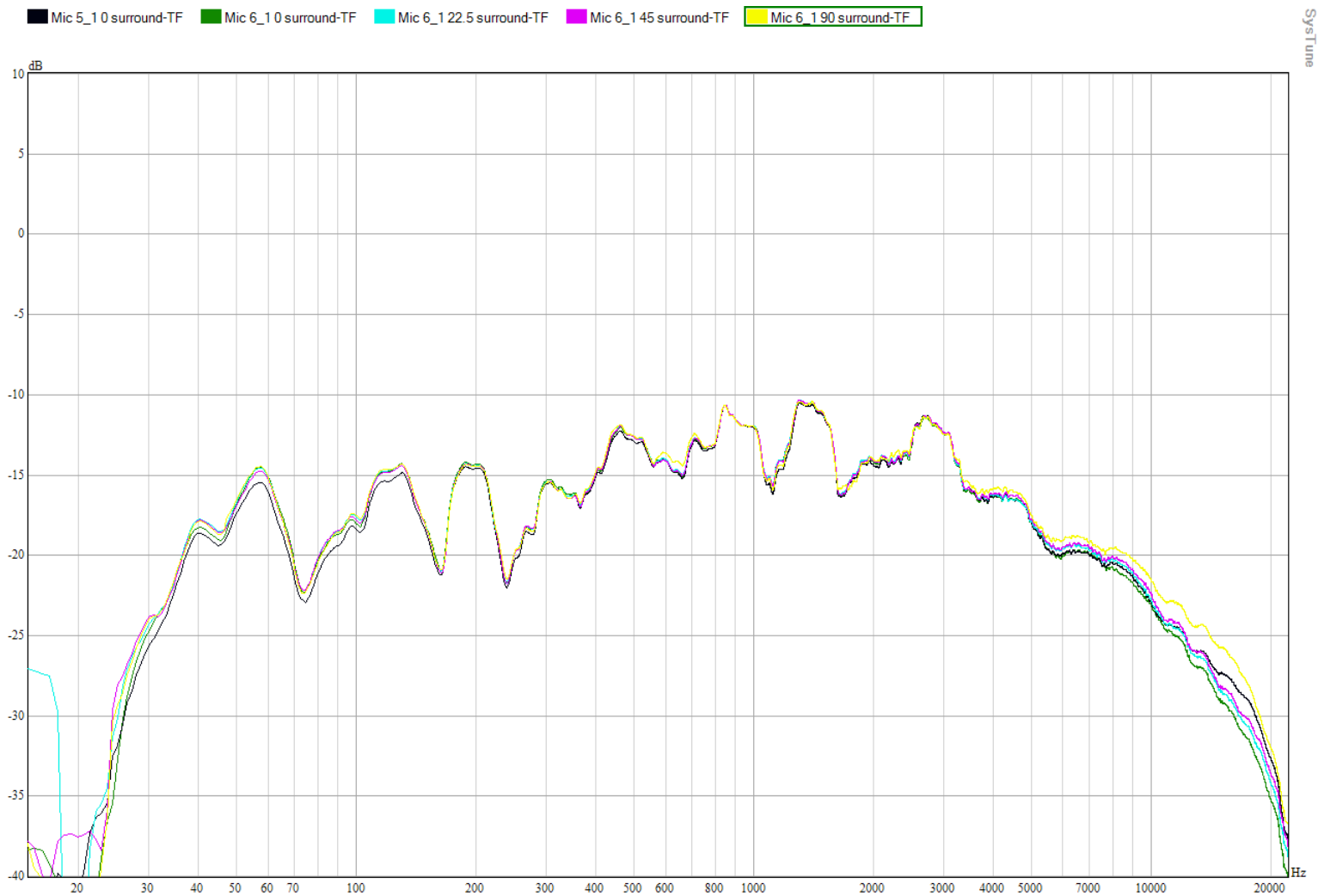

Figure D. 22 – Sample #6 response – sub-woofer channel – 0, 22.5, 45, and 90 degrees compared to reference microphone – sub-woofer channel - 0 degrees (1/3 octave smoothing) (Reference Screening Room)



**Figure D. 23 – Sample #6 response – surround left channel – 0, 22.5, 45, and 90 degrees compared to reference microphone – surround left channel - 0 degrees
 1/3 octave smoothing
 (Reference Screening Room)**

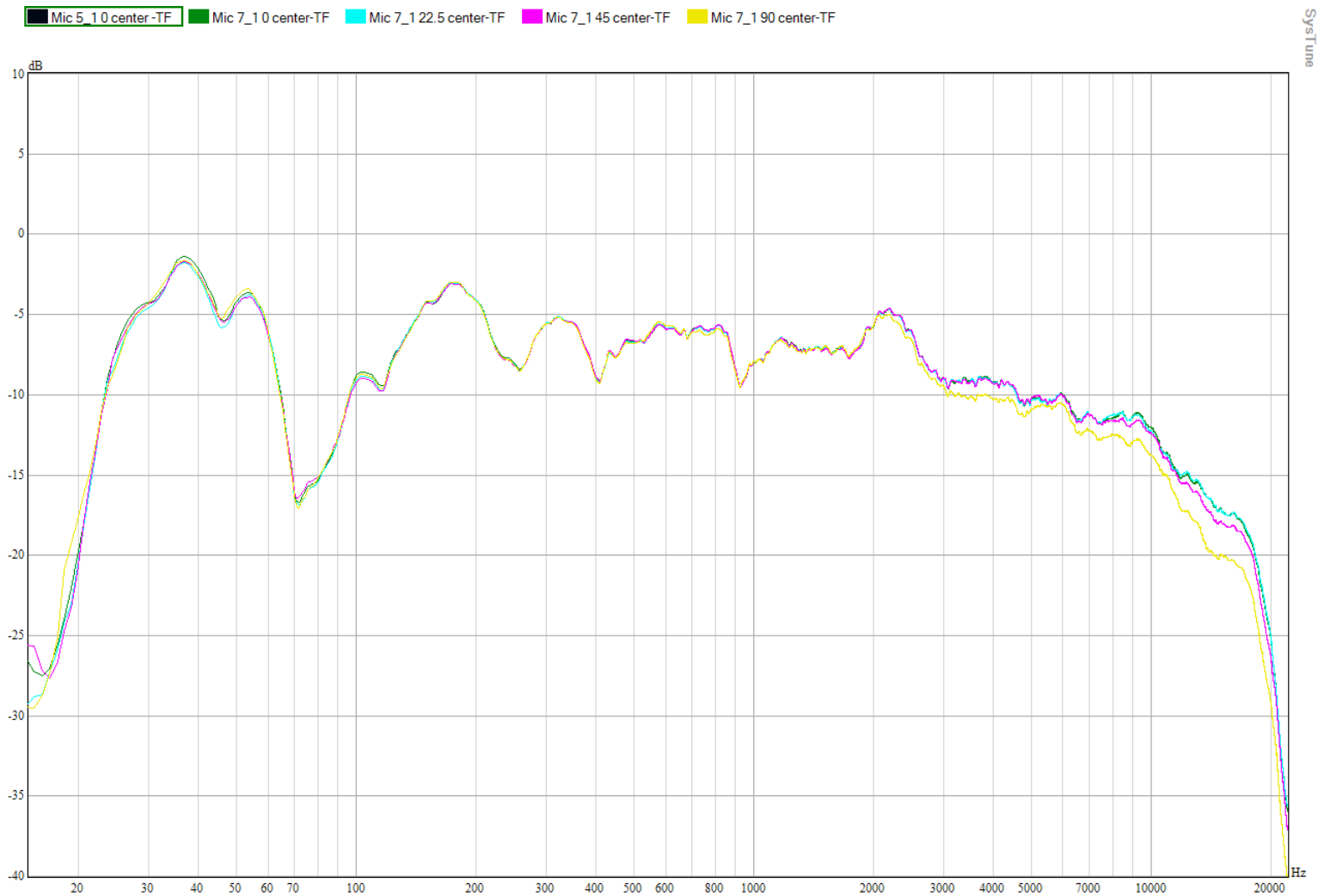

Figure D. 24 – Sample #7 response – center channel – 0, 22.5, 45, and 90 degrees compared to reference microphone - center channel - 0 degrees (1/3 octave smoothing (Reference Screening Room))

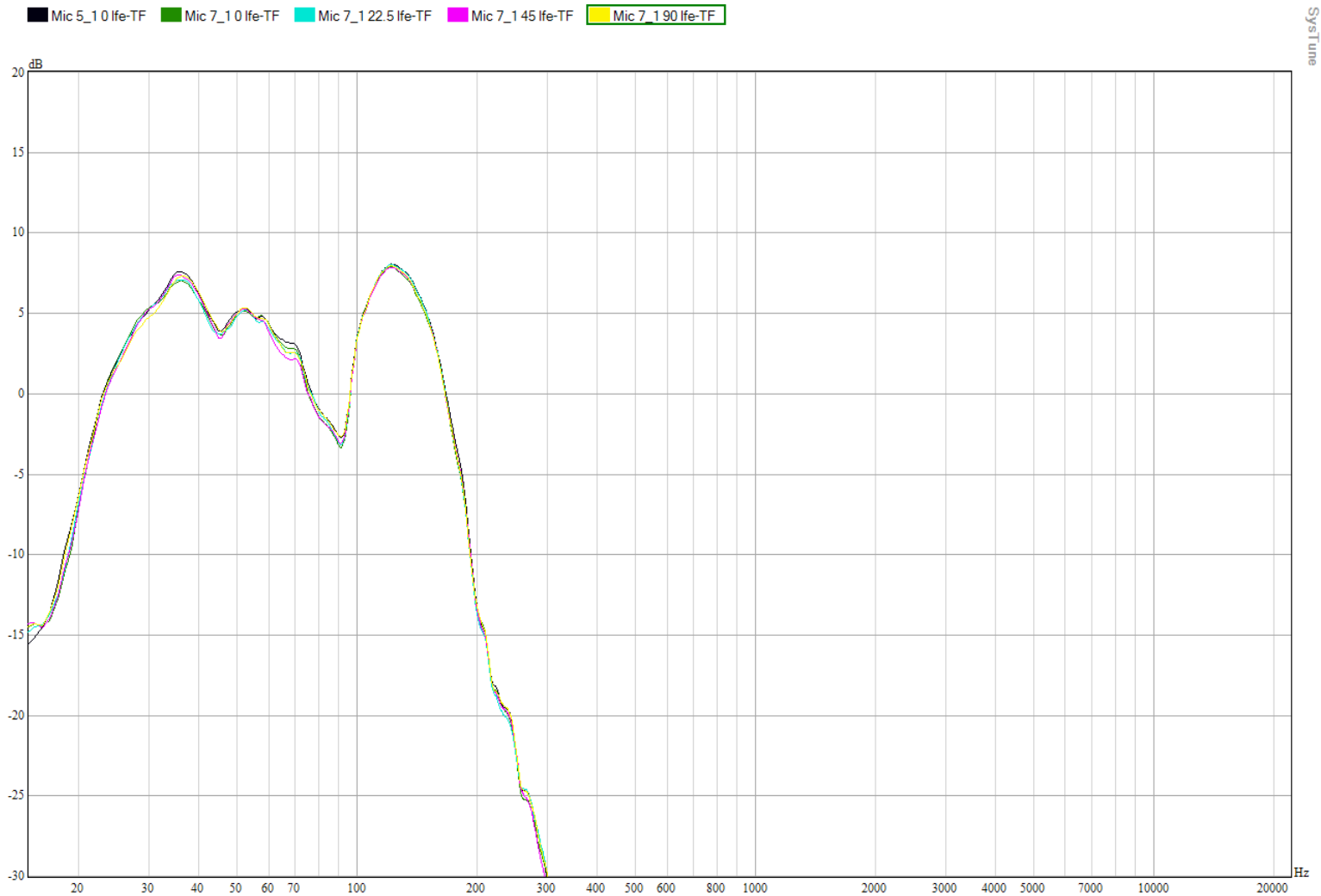
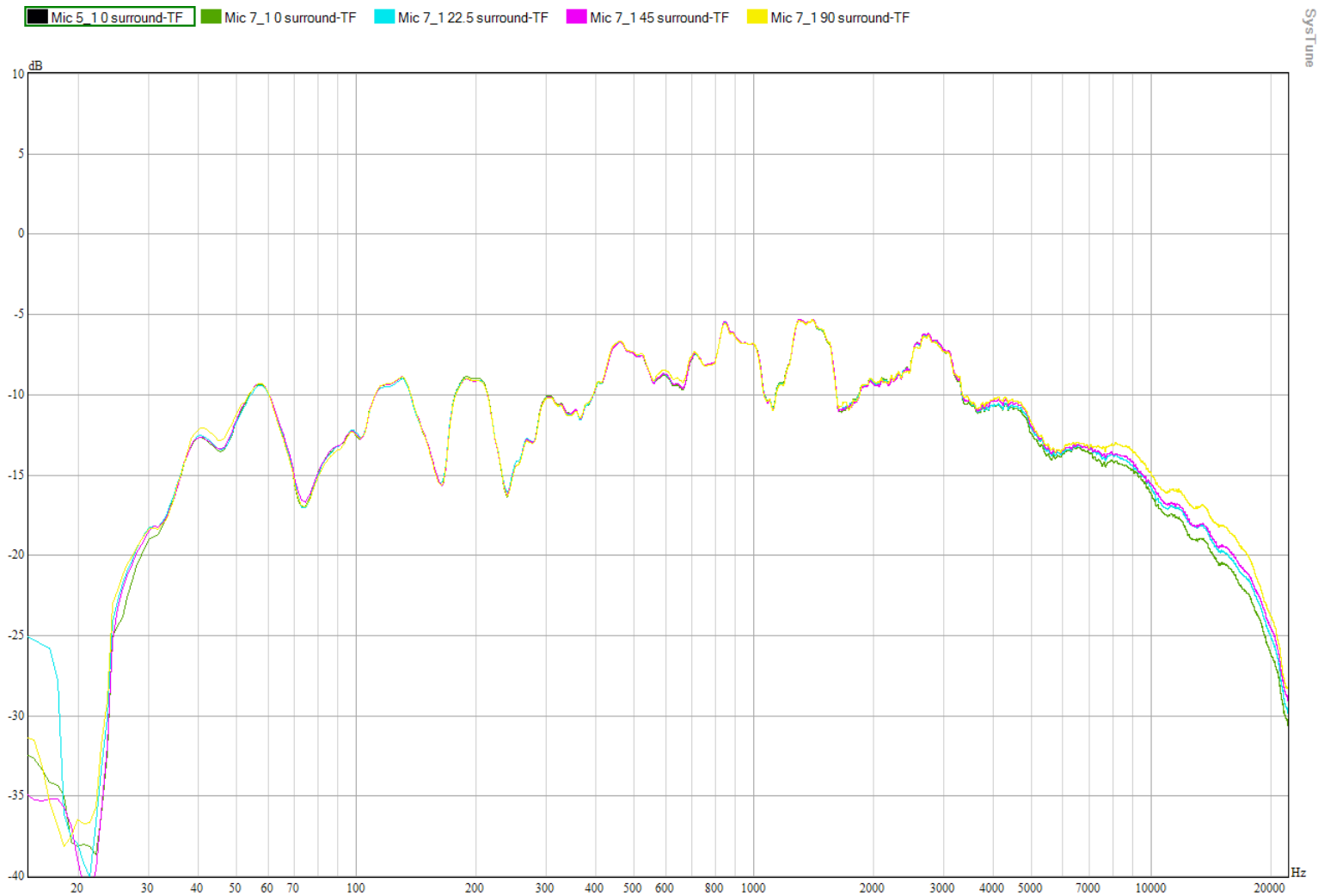

Figure D. 25 - Sample #7 response - sub-woofer channel - 0, 22.5, 45, and 90 degrees compared to reference microphone - sub-woofer channel - 0 degrees (1/3 octave smoothing) (Reference Screening Room)



**Figure D. 26 – Sample #7 response – surround left channel – 0, 22.5, 45, and 90 degrees compared to reference microphone – surround left channel - 0 degrees
 1/3 octave smoothing
 (Reference Screening Room)**



Annex E BIBLIOGRAPHY

1. F. E Toole " Sound Reproduction: Loudspeakers and Rooms", Focal Press 2008
2. F. E. Toole "Home Theaters to Cinemas: Sound Reproduction in Small and Large Rooms", 133rd AES Convention, 2012
3. P. Newell, K. Holland, S. Torres-Guijarro, S. Castro, E. Valdigem; 'Cinema Sound: A New Look at Old Concepts', Proc. IOA Vol. 32, Part 5, 2010. (Presented at Reproduced Sound conference in Cardiff, Wales, Nov. 2010)
4. G. Leembruggen, P. Newell, J. Newell, D. Gilfillan K. Holland, B. McCarty "Is the X curve Damaging Our Enjoyment of Cinema". Presented at SMPTE Conference Sydney Australia 2011
5. M.R. Schroeder "New Method of Measuring Reverberation Time", J. Acoust. Soc. Am., V 37, 1965
6. M.R. Schroeder, 'Integrated-Impulse Method Measuring Sound Decay without Using Impulses', J. Acoust. Soc. Am., V 66, August 1979
7. B. Vessa and D. Weinberg "Can We Make Movie Theaters Sound Better and More Consistent?" SMPTE Mot. Imag. J; November-December 2012; 121:(8) 20-26
8. SMPTE ST 202:2010 Motion-Pictures - Dubbing Theaters, Review Rooms and Indoor Theaters - B-Chain Electroacoustic Response.
9. SMPTE RP 200:2012 Relative and Absolute Sound Pressure Levels for Motion-Picture Multichannel Sound Systems - Applicable for Analog Photographic Film Audio, Digital Photographic Film Audio and D-Cinema
10. D. Griesinger, "The Relationship between Audience Engagement and the ability to Perceive Pitch, Timbre, Azimuth and Envelopment of Multiple Sources" Proc. International Symposium on Room Acoustics, ISRA 2010 Melbourne, Australia.
11. R Schwenke and B Long "Physiological and Psycho-Acoustic basis for Multi-Resolution Frequency Response Analysis," presented at SMPTE 2011 Annual Technical Conference - <http://conferences.smpte.org/content/2011/1/1.21.abstract>.
12. B. Rakerd and W. M. Hartmann "Localization of sound in rooms, III: Onset and duration effects", Journal of the Acoustical Society of America, 80(6) December 1986, 1695-1706
13. T. Holman "Cinema Electro-Acoustic Quality Redux", *SMPTE Mot. Imag. J*; May 2007; 116:(5-6) 220-233
14. M Gander, "Moving-Coil Loudspeaker Topology as an indicator of Linear Excursion Capability", Journal of the Audio Engineering Society, 29(1/2) February 1981, 10-26.
15. A H. Nuttall "Some Windows with Very Good Sidelobe Behavior", IEEE Transactions on Acoustics, Speech, and Signal Processing, 29(1) February 1981, 84-91.
16. A V. Oppenheim, R. W. Schafer, and J. A. Buck "Discrete-time signal processing", Prentice Hall, 1999.
17. S. E. Olive and F. E. Toole "The Detection of Reflections in Typical Rooms", Journal of the Audio Engineering Society, 37(7/8) July 1989, 539-553
18. Densil Cabrera "Resources for Audio & Acoustics", <http://www.densilcabrera.com/wordpress/aarae-2/>
19. F. E. Toole and S. E. Olive, "The Modification of Timbre by Resonances: Perception and Measurement," J. Audio Eng. Soc., 36(3), 1988 March



20. S. E. Olive et al., "The Detection Thresholds of Resonances at Low Frequencies," preprint of the Audio Eng. Soc. 93rd Conv., San Francisco 1992
21. A. Farina "Simultaneous Measurement of Impulse Response and Distortion with a Swept-Sine Technique". Audio Engineering Society Convention 108 2000
22. S. Müller and P. Massarani "Transfer-Function Measurement with Sweeps" Journal of the Audio Engineering Society, 49(6) June 2001 , .443-471
23. J. Eargle, J. Bonner, and D. Ross "The Academy's New State-of-the-Art Loudspeaker System" SMPTE J; June 1985; 94:(6) 667-675
24. B. Long, R Schwenke, P. Soper, G Leembruggen "Further Investigations Into the Interactions Between Cinema Loudspeakers and Screens" SMPTE Mot. Imag J. November-December 2012 vol. 121 no. 8 46-62
25. P. Newell, J. Guijarro Garcia, K. Holland, "Acoustics of Cinema Screens". Presented at Reproduced Sound conference in Manchester, Nov. 2013
26. T. Holman, "Motion-Picture Theater Sound System Performance: New Studies of the B-Chain", SMPTE J; March 1994; 103:(3) 136-149



Annex F CREDITS

The TC-25CSS AHG B-chain Study Group Theater Testing Data Report acknowledges the following contributors:

Venue response processing and analysis, report writing, editing and document production:

Glenn Leembruggen

Chief Writers:

Brian Vessa
Philip Newell
Neil Shaw
Kurt Graffy.
Ioan Allen
Floyd Toole

Additional Contributors:

Harold Hallikainen
Calvert Dayton
Brian McCarty
Gunter Oehme
David Gilfillan
Mark Thompson
Roy Waldspurger
David J. Weinberg

The “Zero Dark Thirty” Theater Testing Team:

Neil Shaw
Nelson Meacham
Bruce C. Olson
Tim Holmes
Andy Potvin
Miles Rogers
Pete Soper
Andrew Poulain
Steve Martz
Brian Long
Roy Waldspurger
Brian Vessa

Original proponent of the work

Brian McCarty

TC 25CSS Cinema Sound Systems Co-Chairpersons

Brian Vessa
Kurt Graffy



TC-25CSS AHG B-chain Study Group Theater Testing Data Report Members:

Dan Abrams
John Allen
Ioan R. Allen
Giles Babich
Matt Basford
Christopher Cain
Charles Flynn
Richard Furse
Mark Gander
Linda Gedemer
Kurt Graffy
Douglas Greenfield
Harold Hallikainen
Brandon Harold
Siegfried Heep
Ingo Hontsch
John Hurst
Benjamin Ing
Michael Karagosian
Glenn KnickKrehm
Glenn Leembruggen
Jeffrey Levison
Brian Long
Andre Lopes
Brian McCarty
Lon Neumann
Philip Newell
Gunter Oehme
Miles Rogers
Ikuko Sawaya
Florian Schleich
David Schnuelle
Thomas A. Scott
Neil Shaw - Chairman
Steven Shurtz
Peter Soper
Lawrence St-Onge
Peter Symes
Paul Treleaven
Brian Vessa
Roy Waldspurger
David J. Weinberg - Secretary