

OPTION 1: ZK-5000

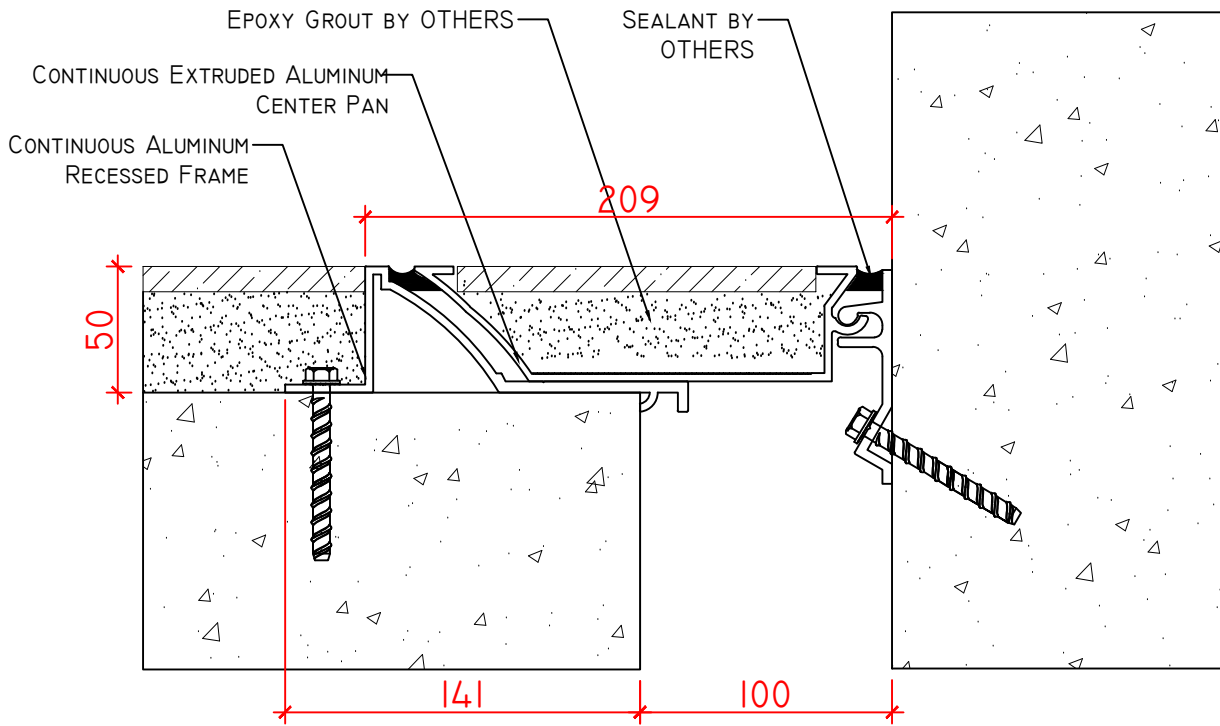

OPTION 2: ZK-5000 + WATER BARRIER

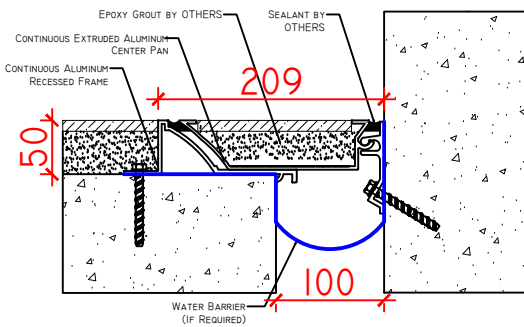

OPTION 3: ZK-5000 + FIRE BARRIER

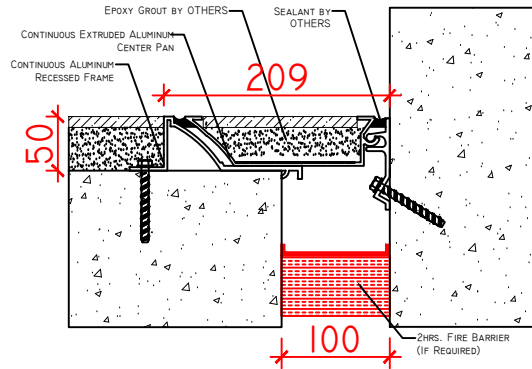

OPTION 4: ZK-5000 + WATER BARRIER + FIRE BARRIER

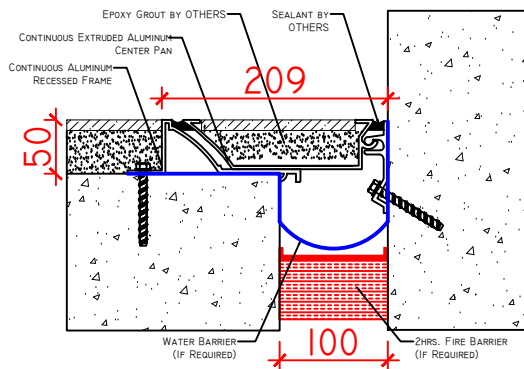

SKU	NAME	JOINT WIDTH, JW(MM)	HEIGHT, H(MM)	SIGHTLINE, S(MM)	MOVEMENT CAPACITY %	LOAD CAPACITY (KN)
ZK5000I0050209	ZK-5000-100	50-110	50	209	±50	10



PRODUCT TYPE: EXPANSION JOINT COVER
 APPLICATION: FLOOR TO WALL CONDITION
 APPROVED BY CLIENT: