

OPTION 1: Z-II00

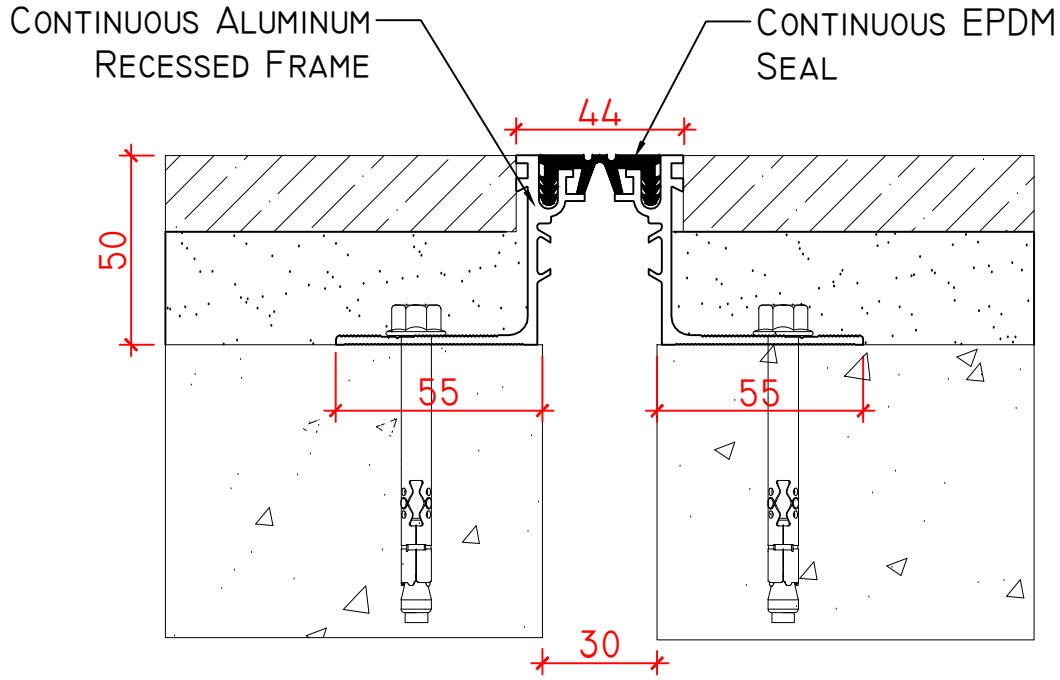

OPTION 2: Z-II00 + WATER BARRIER

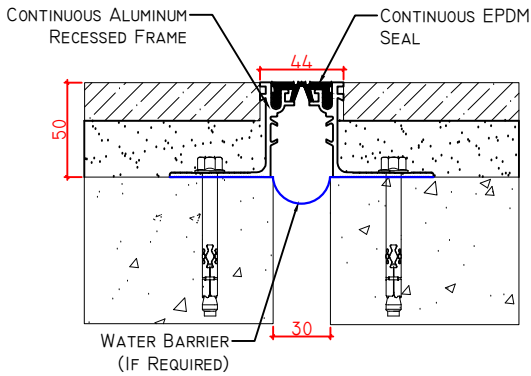

OPTION 3: Z-II00 + FIRE BARRIER

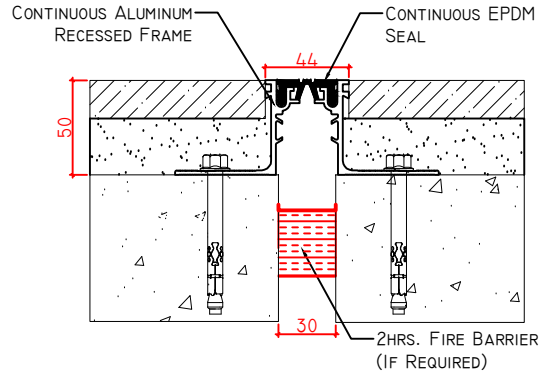

OPTION 4: Z-II00 + WATER BARRIER + FIRE BARRIER

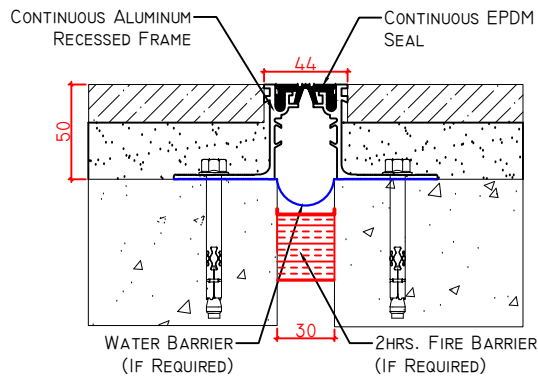

SKU	NAME	JOINT WIDTH, JW(MM)	HEIGHT, H(MM)	SIGHTLINE, S(MM)	MOVEMENT CAPACITY %	LOAD CAPACITY (KN)
ZII00305044	Z-II00-30	30	50	44	±20	30



GENOTEK

PRODUCT TYPE: EXPANSION JOINT COVER

APPLICATION: FLOOR TO FLOOR CONDITION

APPROVED BY CLIENT: