

OPTION 1: ZK-II00

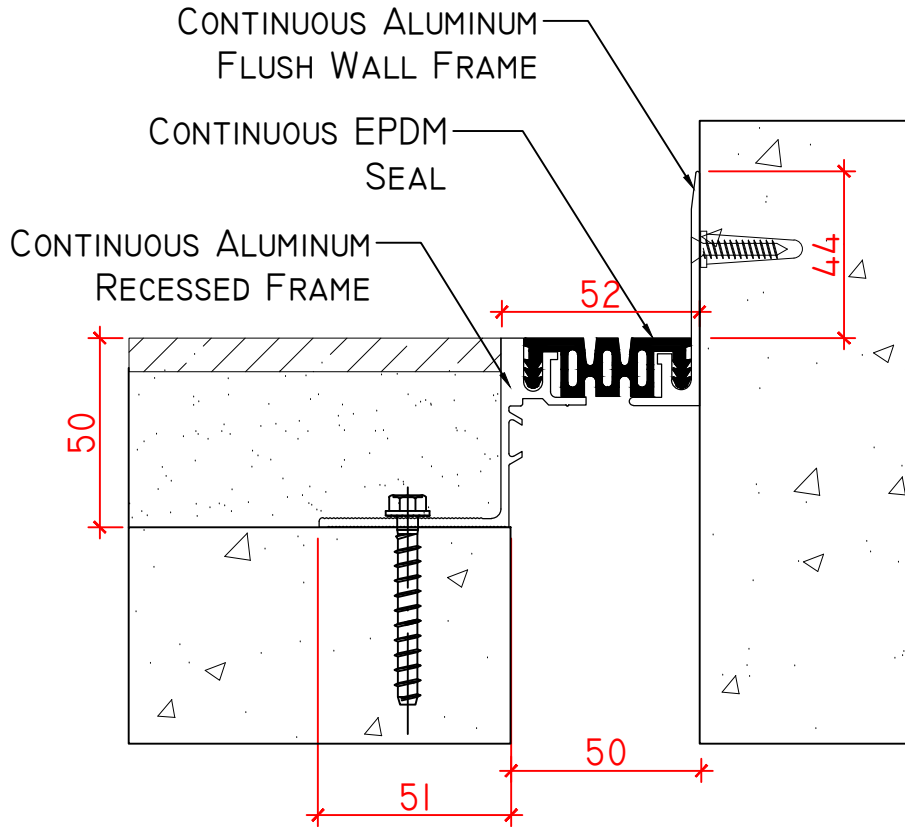

OPTION 2: ZK-II00 + WATER BARRIER

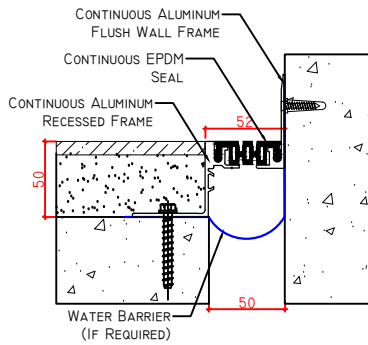

OPTION 3: ZK-II00 + FIRE BARRIER

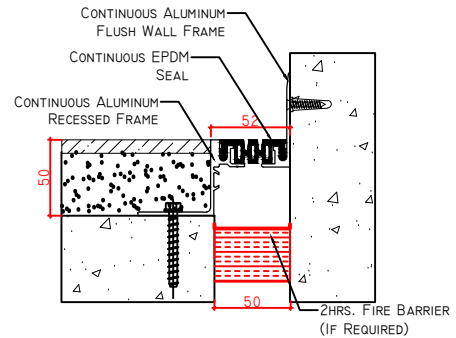

OPTION 4: ZK-II00 + WATER BARRIER + FIRE BARRIER

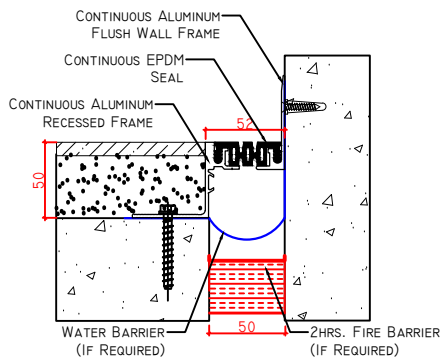

SKU	NAME	JOINT WIDTH, JW(MM)	HEIGHT, H(MM)	SIGHTLINE, S(MM)	MOVEMENT CAPACITY %	LOAD CAPACITY (KN)
ZKII00505052	ZK-II00-50	50	50	52	±24	20



PRODUCT TYPE: EXPANSION JOINT COVER
APPLICATION: FLOOR TO WALL CONDITION
APPROVED BY CLIENT: