

OPTION 1: Z-4100A

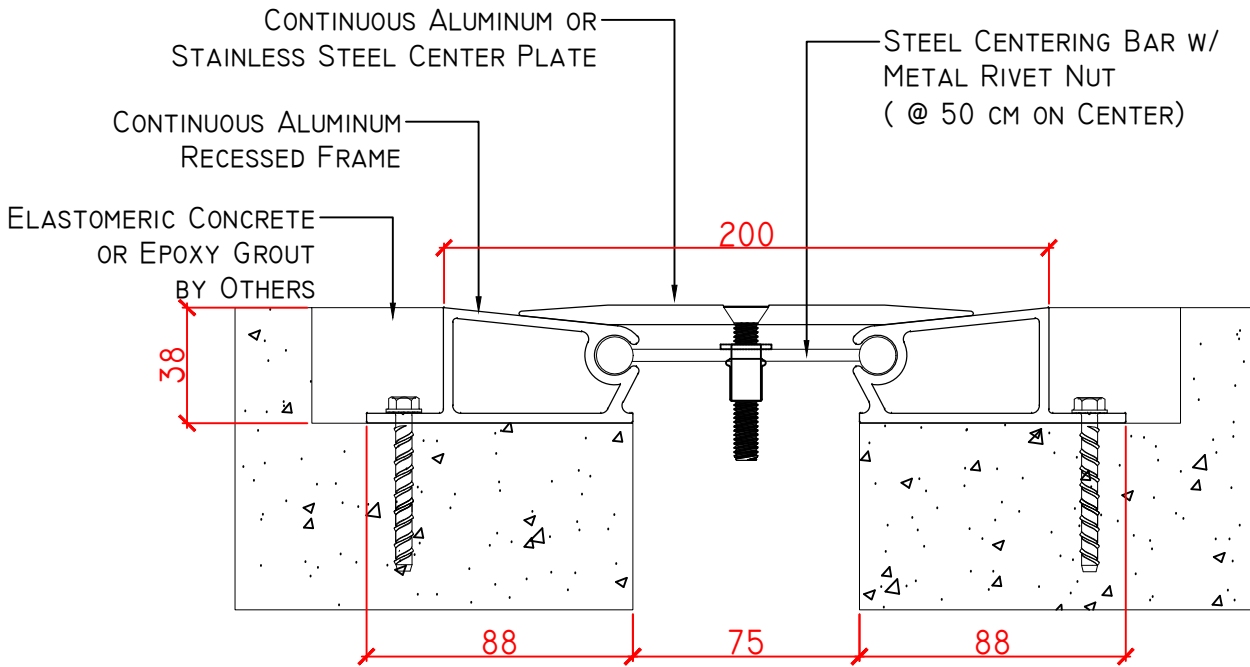

OPTION 2: Z-4100A + WATER BARRIER

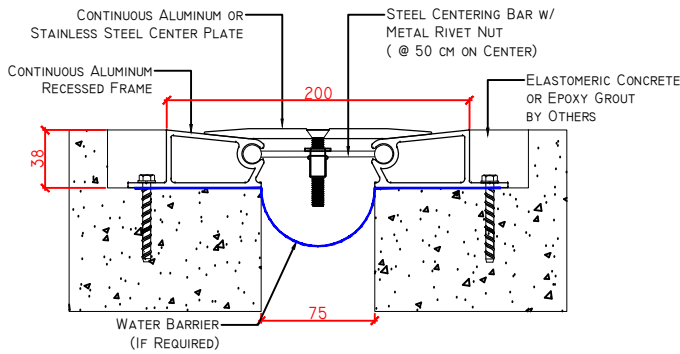

OPTION 3: Z-4100A + FIRE BARRIER

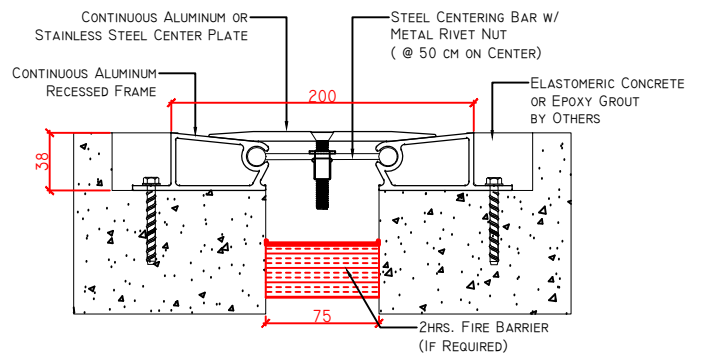

OPTION 4: Z-4100A + WATER BARRIER + FIRE BARRIER

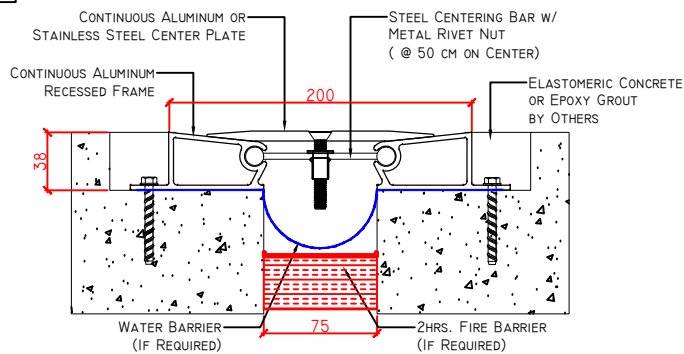

SKU	NAME	JOINT WIDTH, JW(MM)	HEIGHT, H(MM)	SIGHTLINE, S(MM)	MOVEMENT CAPACITY %	LOAD CAPACITY (KN)
Z4100A7538200	Z-4100A-75	75	38	200	±50	90



PRODUCT TYPE: EXPANSION JOINT COVER

APPLICATION: FLOOR TO FLOOR CONDITION

APPROVED BY CLIENT: