

OPTION 1: ZK-4100A

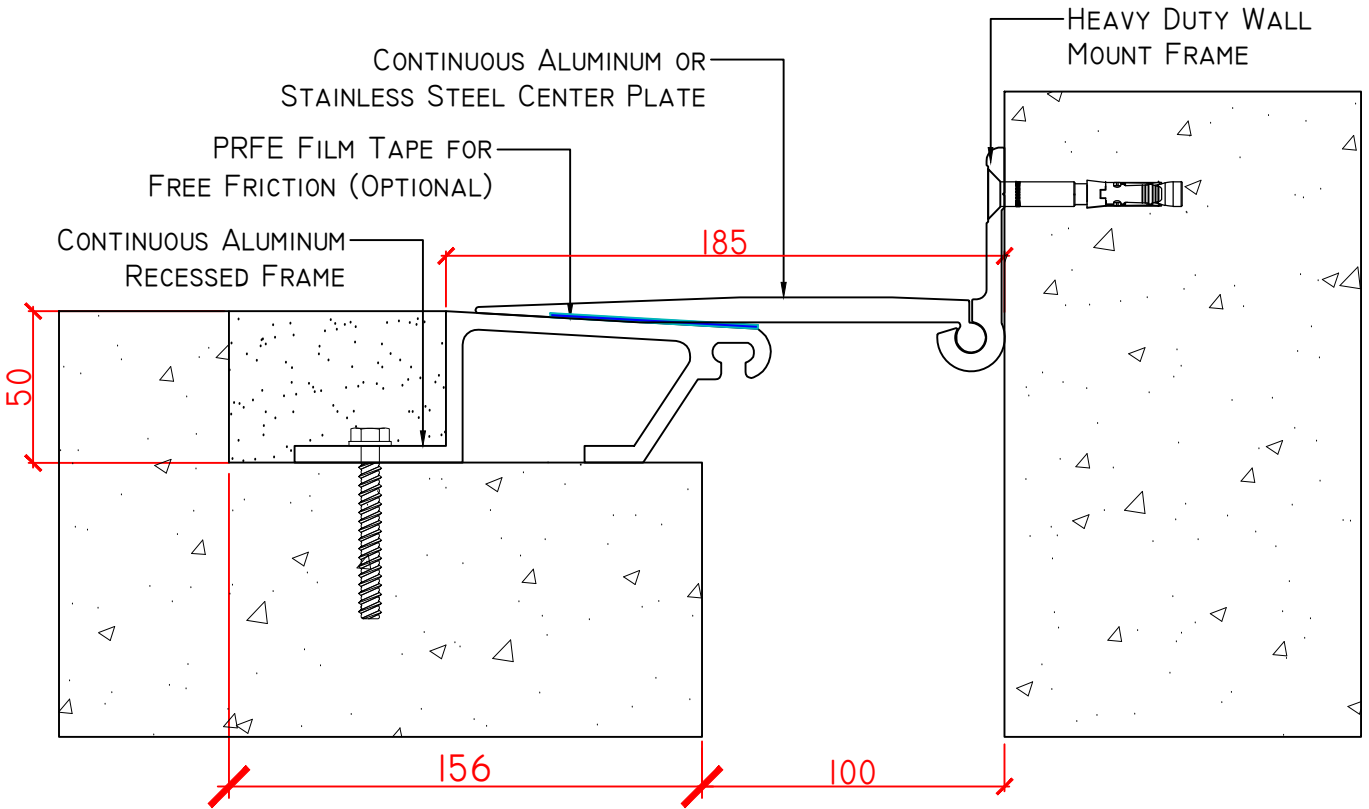

OPTION 2: ZK-4100A + WATER BARRIER

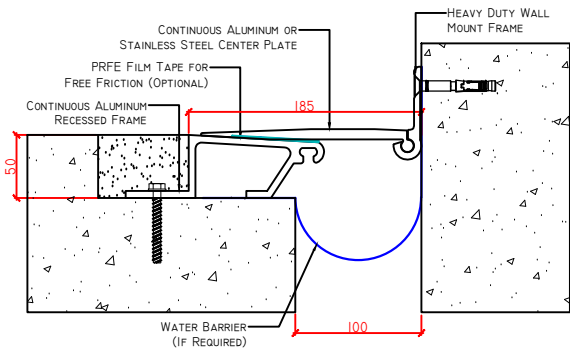

OPTION 3: ZK-4100A + FIRE BARRIER

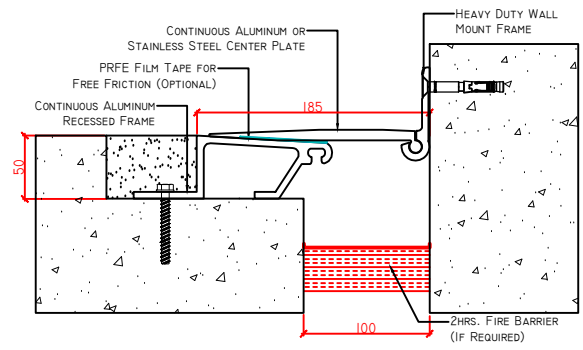

OPTION 4: ZK-4100A + WATER BARRIER + FIRE BARRIER

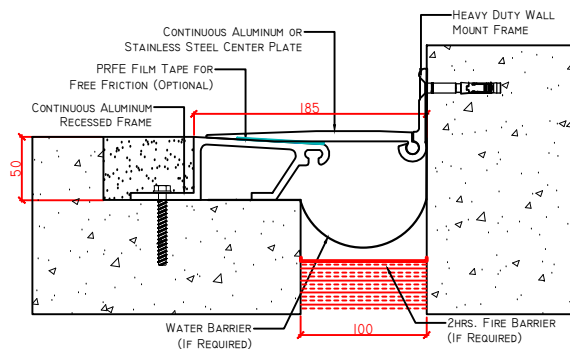

SKU	NAME	JOINT WIDTH, JW(MM)	HEIGHT, H(MM)	SIGHTLINE, S(MM)	MOVEMENT CAPACITY %	LOAD CAPACITY (KN)
ZK4100A10050185	ZK-4100A-100	100	50	185	±50	60



PRODUCT TYPE: EXPANSION JOINT COVER

APPLICATION: FLOOR TO WALL CONDITION

APPROVED BY CLIENT: