

OPTION 1: ZK-5001

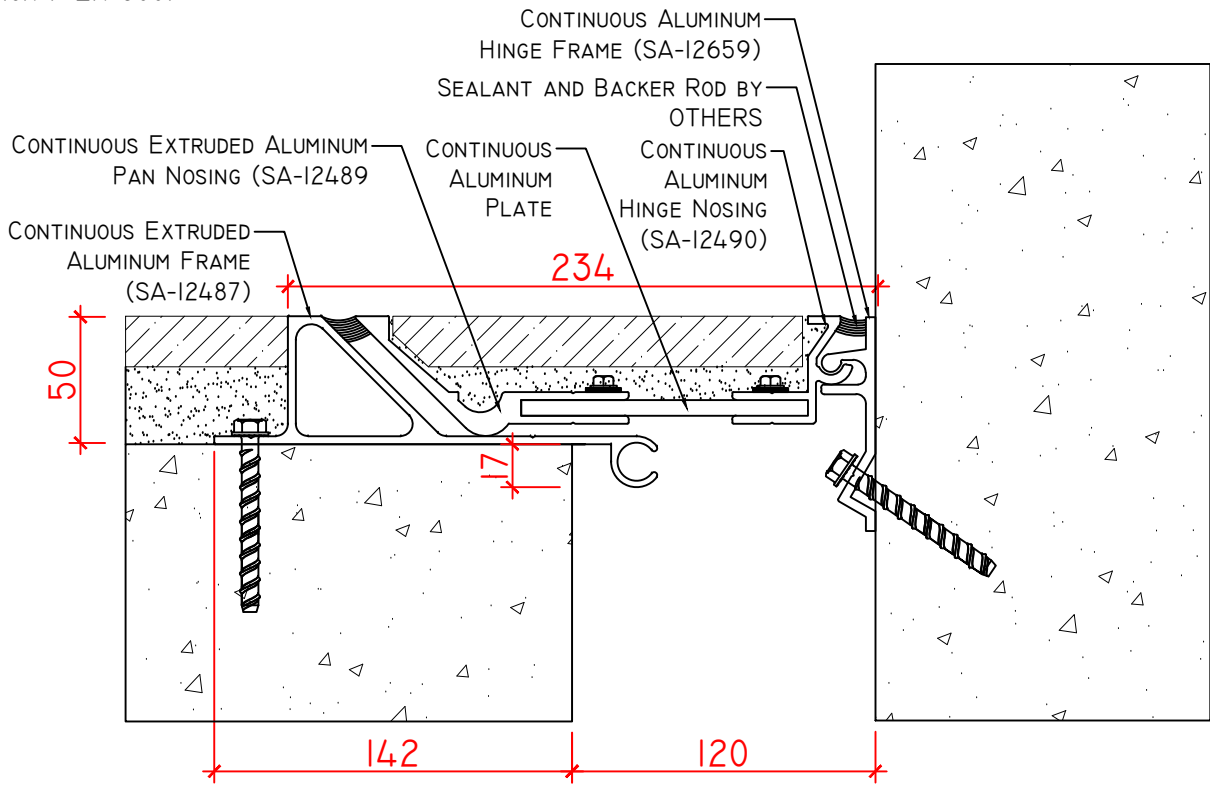

OPTION 2: ZK-5001 + WATER BARRIER

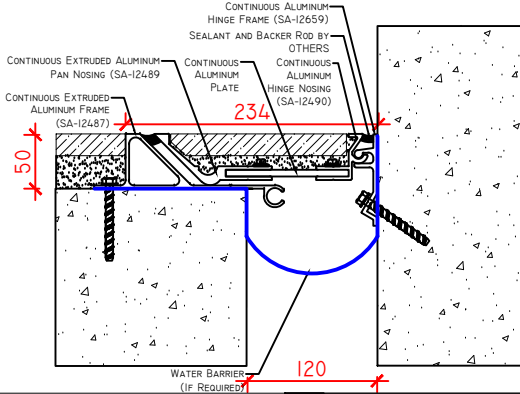

OPTION 3: ZK-5001 + FIRE BARRIER

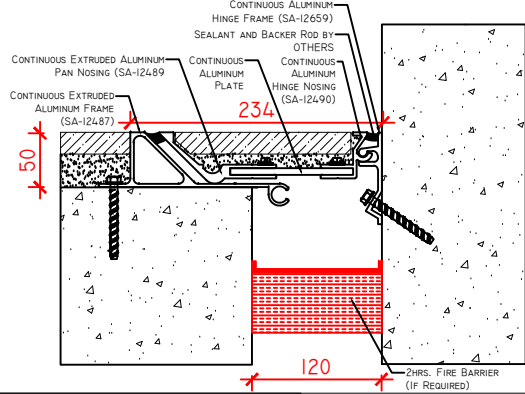

OPTION 4: ZK-5001 + WATER BARRIER + FIRE BARRIER

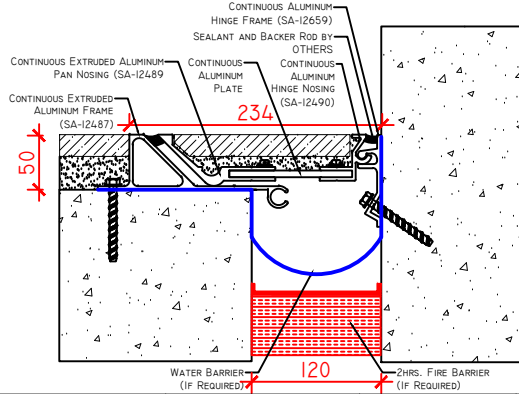

SKU	NAME	JOINT WIDTH, JW(MM)	HEIGHT, H(MM)	SIGHTLINE, S(MM)	MOVEMENT CAPACITY %	LOAD CAPACITY (KN)
ZK5001I2050234	ZK-5001-120	120	50	234	±50	20



PRODUCT TYPE: EXPANSION JOINT COVER

APPLICATION: FLOOR TO WALL CONDITION

APPROVED BY CLIENT: