

OPTION 1: Z-5200

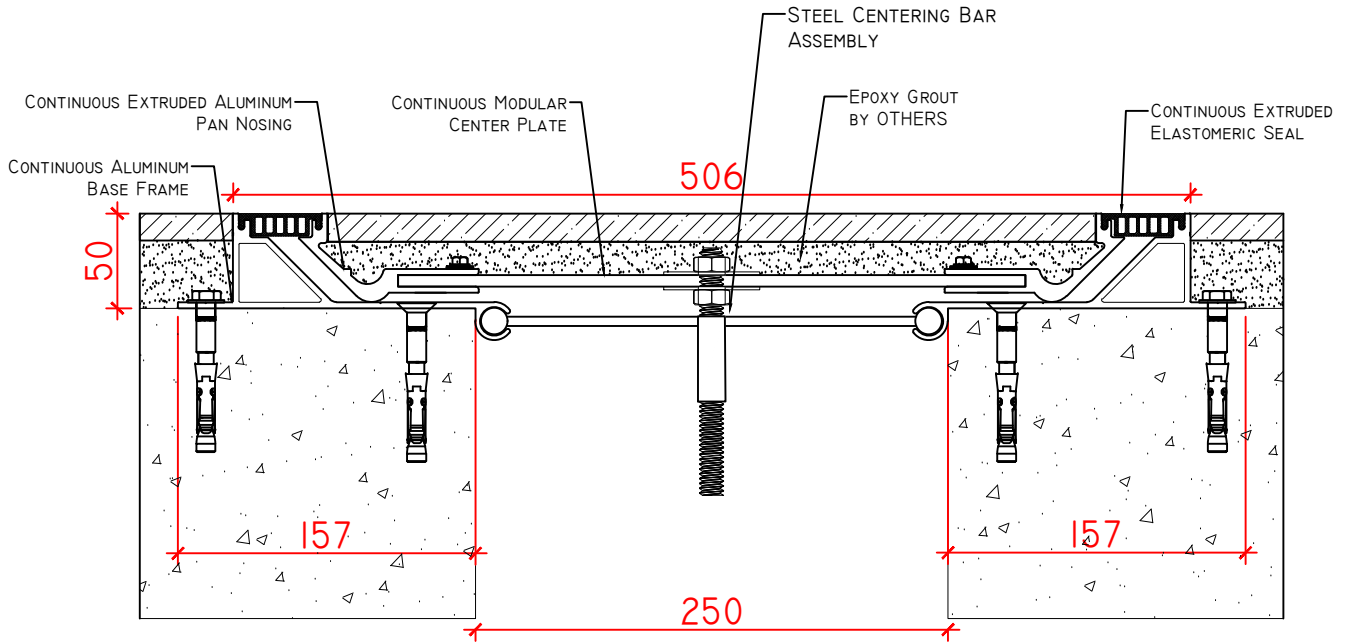

OPTION 2: Z-5200 + WATER BARRIER

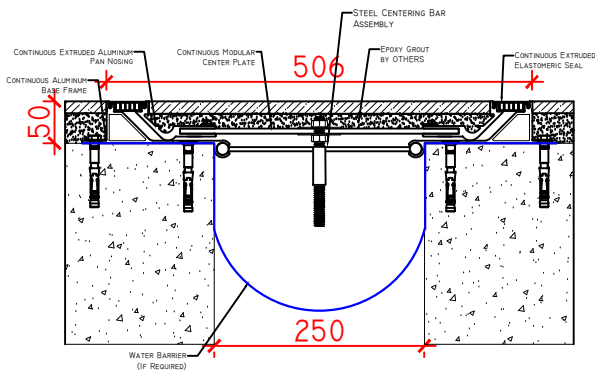

OPTION 3: Z-5200 + FIRE BARRIER

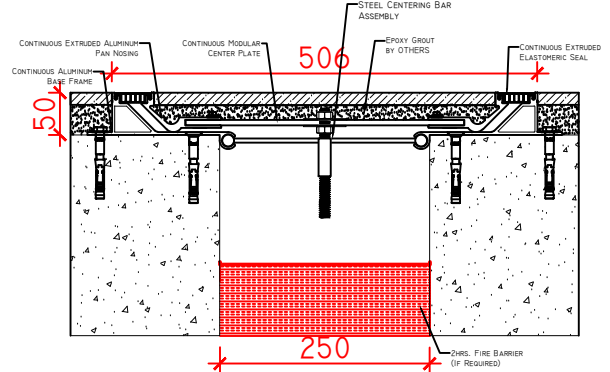

OPTION 4: Z-5200 + WATER BARRIER + FIRE BARRIER

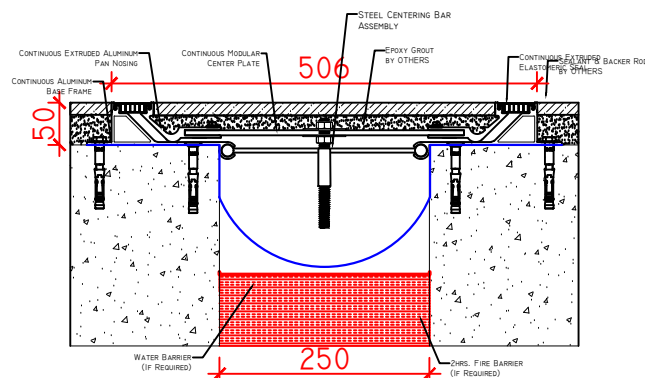

SKU	NAME	JOINT WIDTH, JW(MM)	HEIGHT, H(MM)	SIGHTLINE, S(MM)	MOVEMENT CAPACITY %	LOAD CAPACITY (KN)
Z520025050506	Z-5200-250	220-260	50	506	±25	10



PRODUCT TYPE: EXPANSION JOINT COVER

APPLICATION: FLOOR TO FLOOR CONDITION

APPROVED BY CLIENT: