

## MultiBall Mini - Setup Guide 3.3

Fun With Balls GmbH

# Technical Specifications MultiBall Mini

## What's In The Box

Console  
Sensor Frame  
AC Power Cord  
Installation Guide

## Dimensions (WxHxD)

329 x 235 x 14 cm

## Connectivity

Power: 110V / 220V / 230V  
Internet: Ethernet / USB (Mobile Hotspot)  
Video: HDMI (use quality cables)

## Audio

Internal Sound System



# Technical Specifications MultiBall Mini

The System needs a Projector, that is mounted as close and high as possible to avoid shadows.

- Use a high quality HDMI cable.

## Recommended Projectors:

- Panasonic PT-VMZ40
- Panasonic PT-VMZ60
- Panasonic PT-VZ470

## Required Resolution:

- WUXGA (1920 x 1200)
- WXGA (1280 x 800)

## Required Aspect Ratio

- 16:10

Use this site to accurately calculate the distance you need for lens and projector:

<https://panasonic.net/cns/projector/calculator/tdc/index.html>

Please ask a local projector dealer to help you choose the right projector for your light conditions and the projector distance.

## Recommended play area:

4,2m x 4,2m

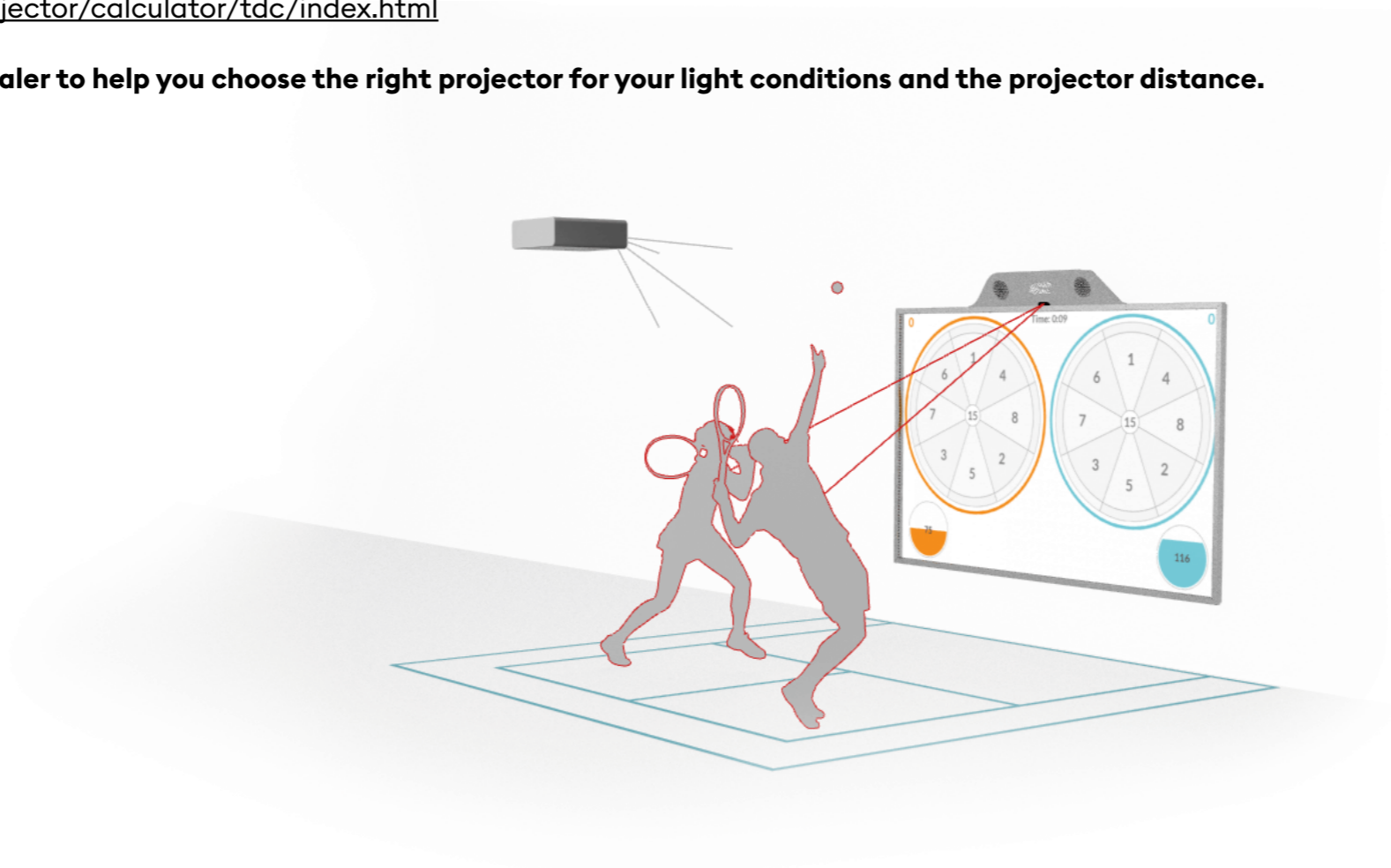

**Dimensions in mm**

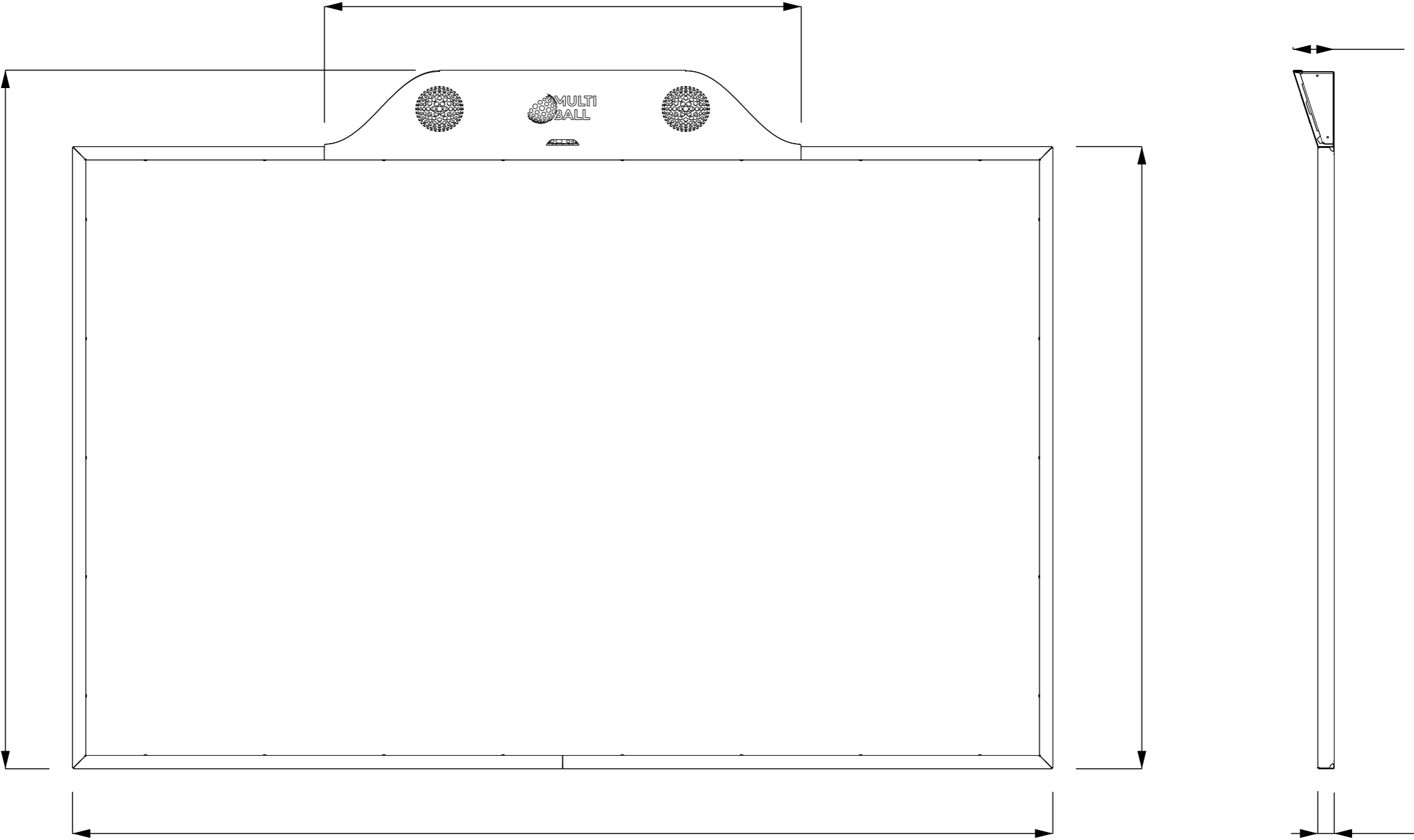

# Hardware

Console

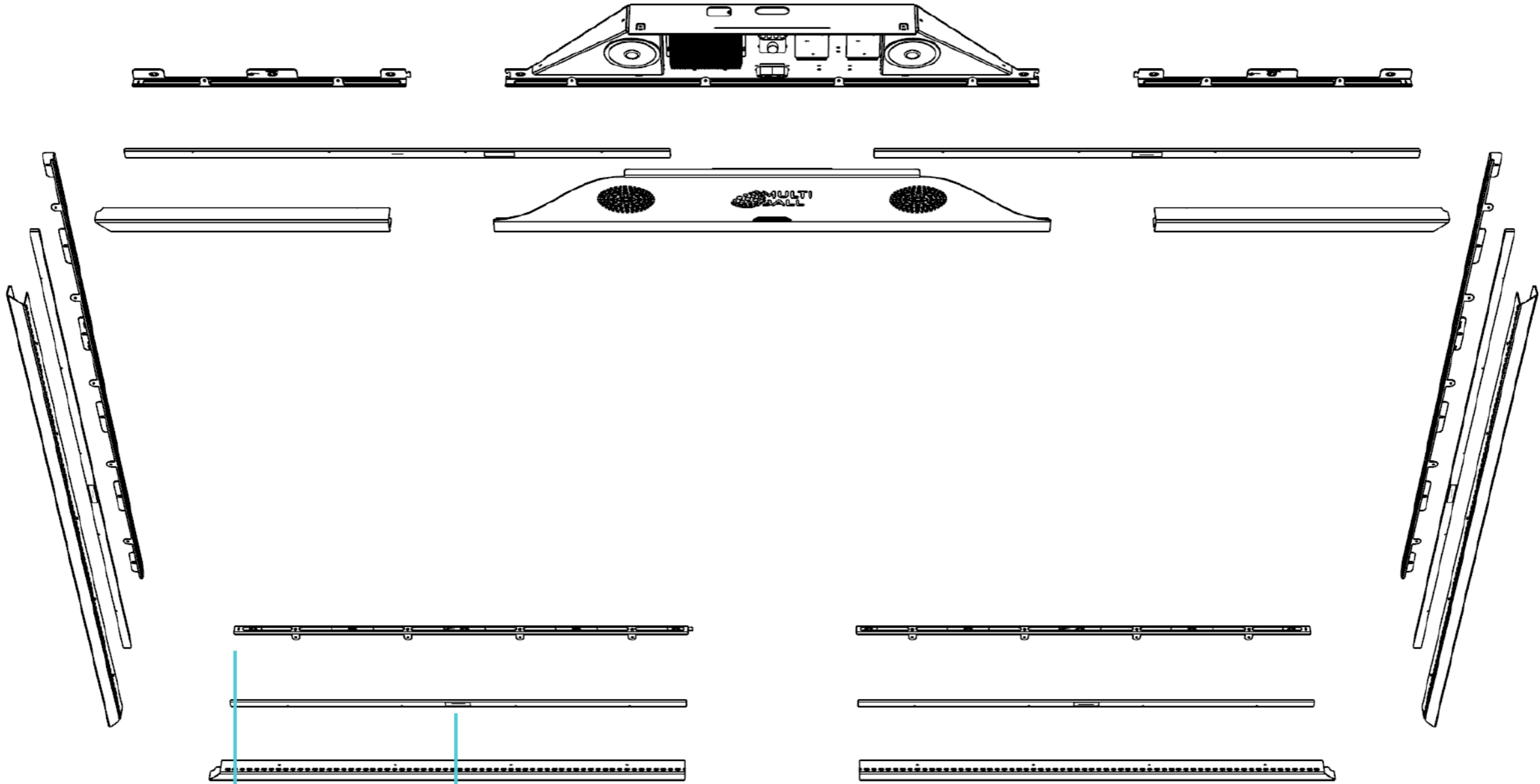

Holder (x6)

Sensor (x6)

Cover (x6)

Sensor Bolt M4 (x26)

Cover Bolt M6 (x26)

# Cable Management

There are 7 cable outlets to run the HDMI, LAN and power cable.

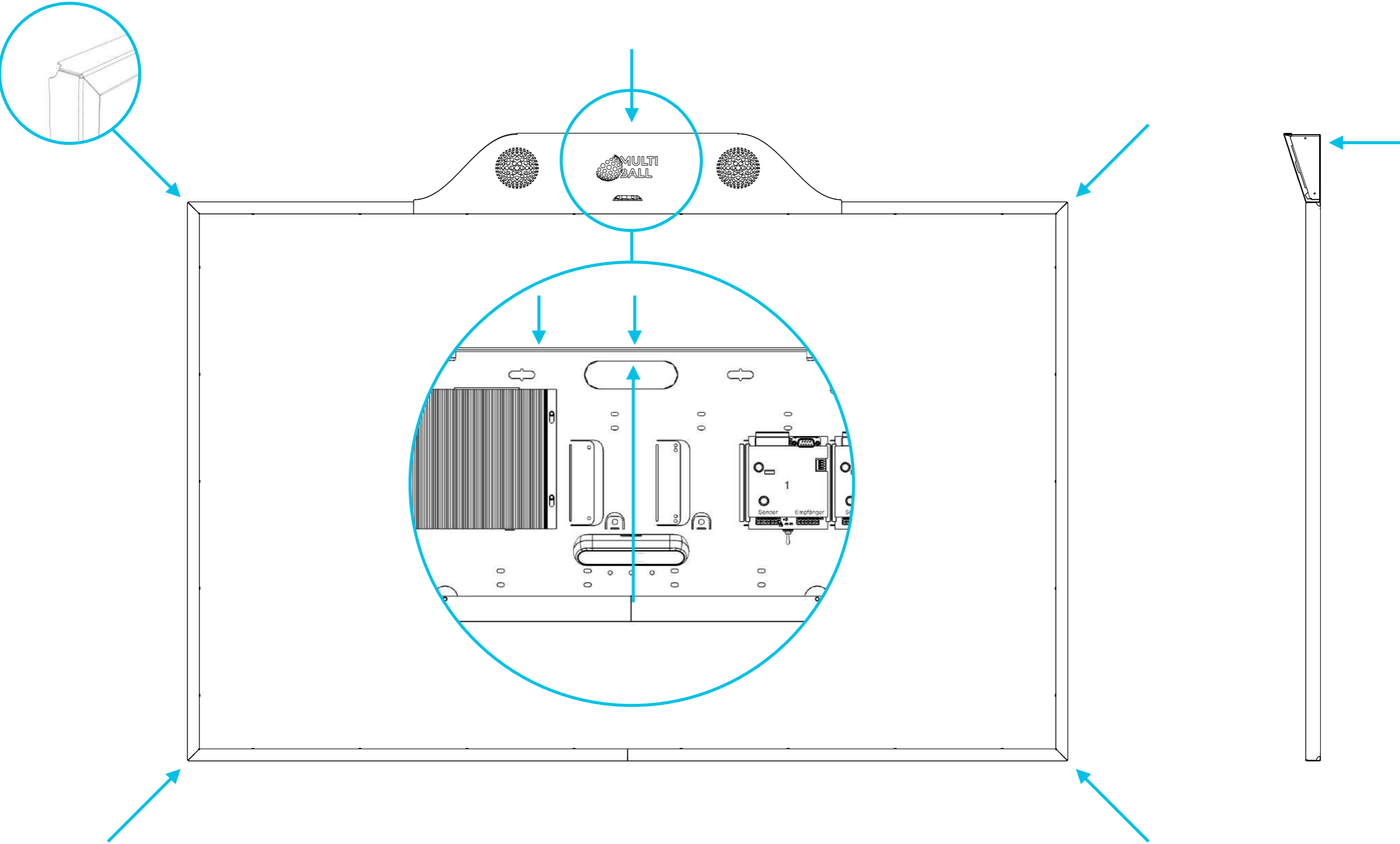

# Recommended Equipment

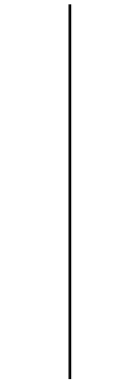
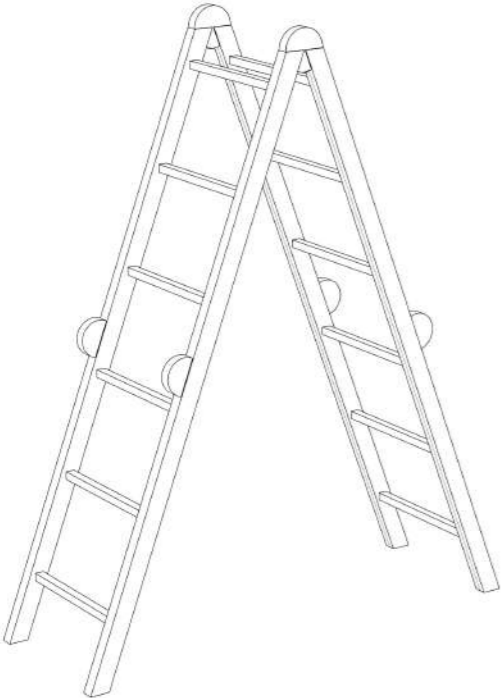

Ladder

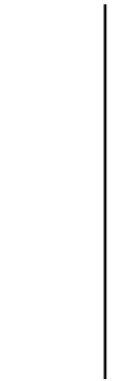

Laser Level

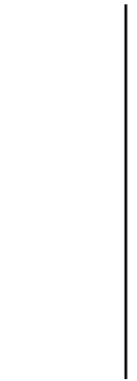
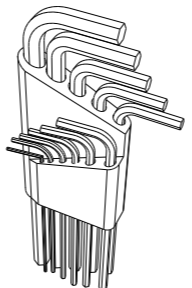

Allen Key Set

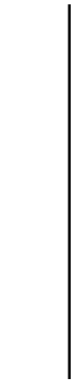
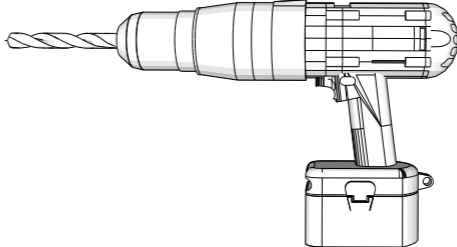

Drill

There are 34 holes with a diameter of 8mm.



Screws and Dowels for Wall Mounting

# Step 1

## Open Console

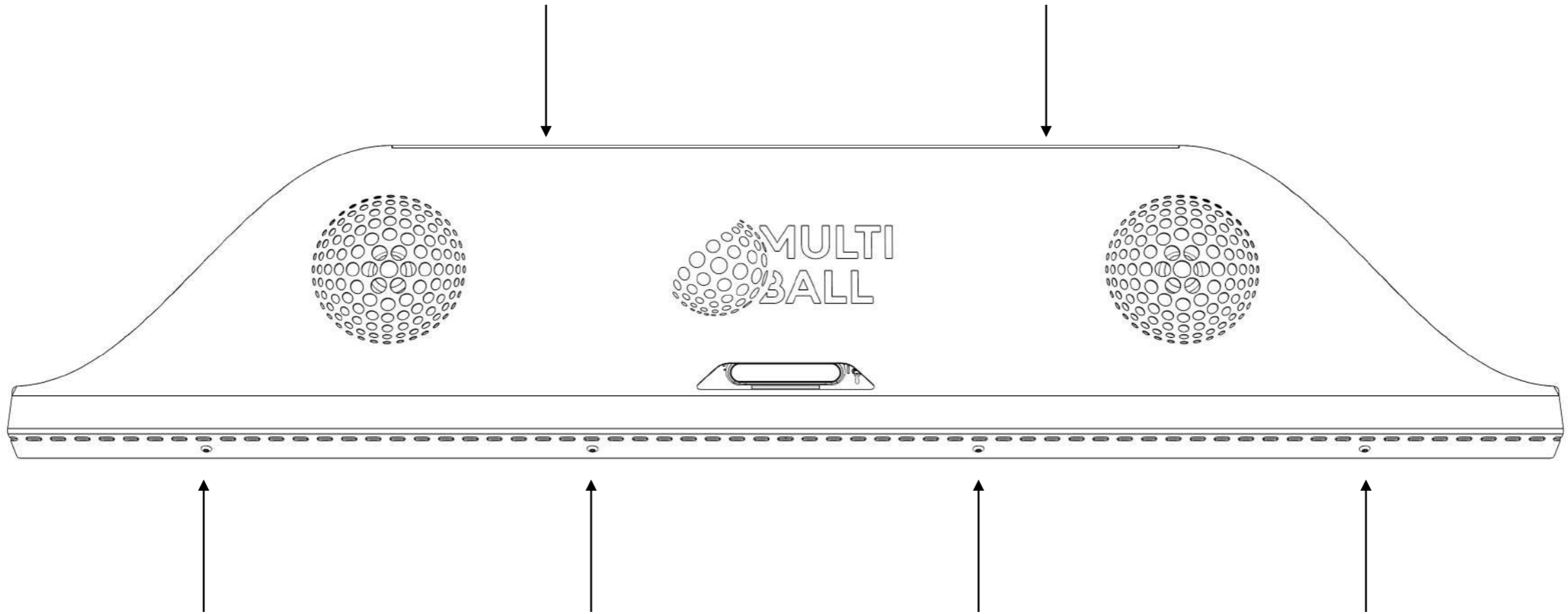

**i** Remove the 6 screws and lift up the cover.



## Step 2

### Mount Holders and Console

1. Mount the Bottom Holders  
Left and Right touching each other.  
(Distance to floor 20mm)
2. Mount Left Side and Right Side.
3. Verify Left and Right are fully  
leveled and parallel.
4. Mount Top Left and Top Right.
5. Mount Console (next page).

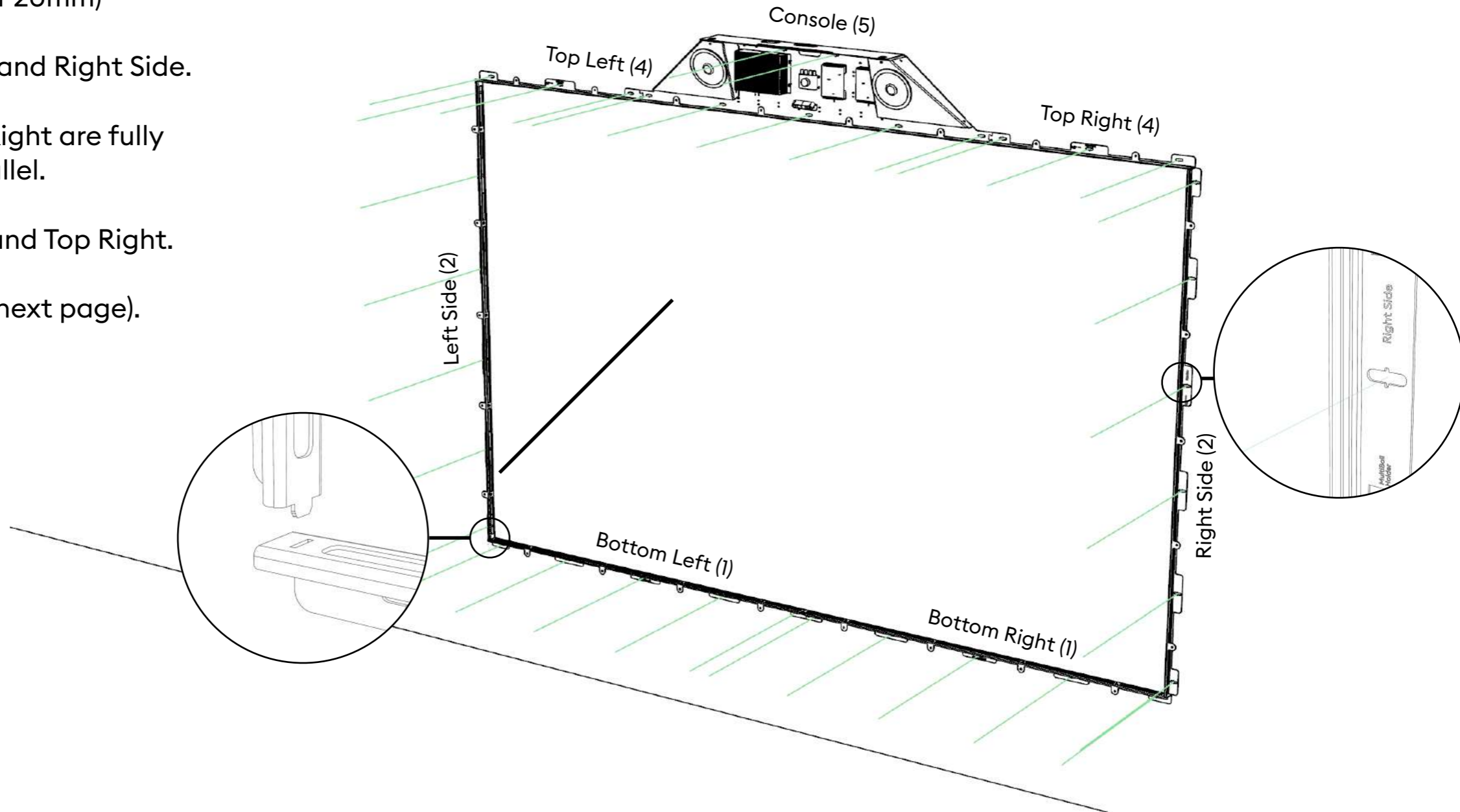

Please always make sure all profiles are leveled in order to make the top Frames touch each other with no gap.



Please select the suitable bolts, dowels and washers to attach the frame to the wall according to wall properties (2-4 screws per part).

# Step 2

## Mount Console

Secure the Console with 7 bolts.

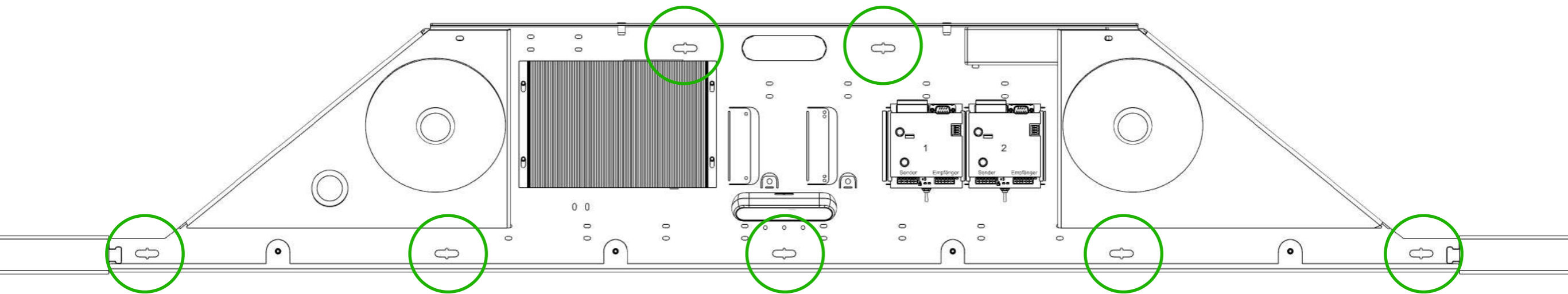

# Step 3

## Mount the Sensors

Mount all Sensors with the red surface facing inwards.

The sticker must face you.

Use **Sensor Bolt M4**.

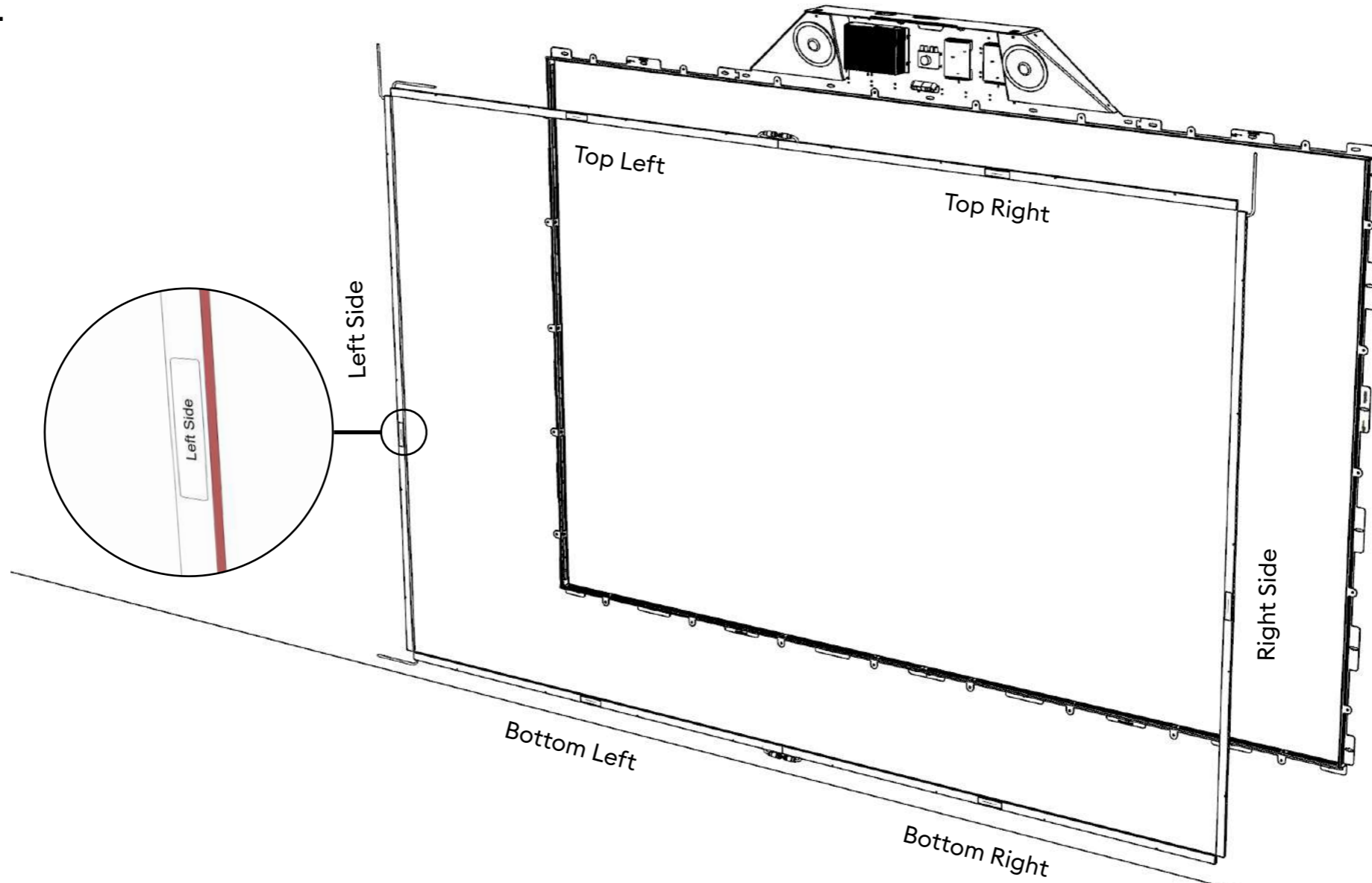

**Sensor Bolt M4**



## Step 4

### Connect Sensors

1. Connect the Sensor Top Left with Top Right.
2. Connect the Sensor Bottom Left with Bottom Right.

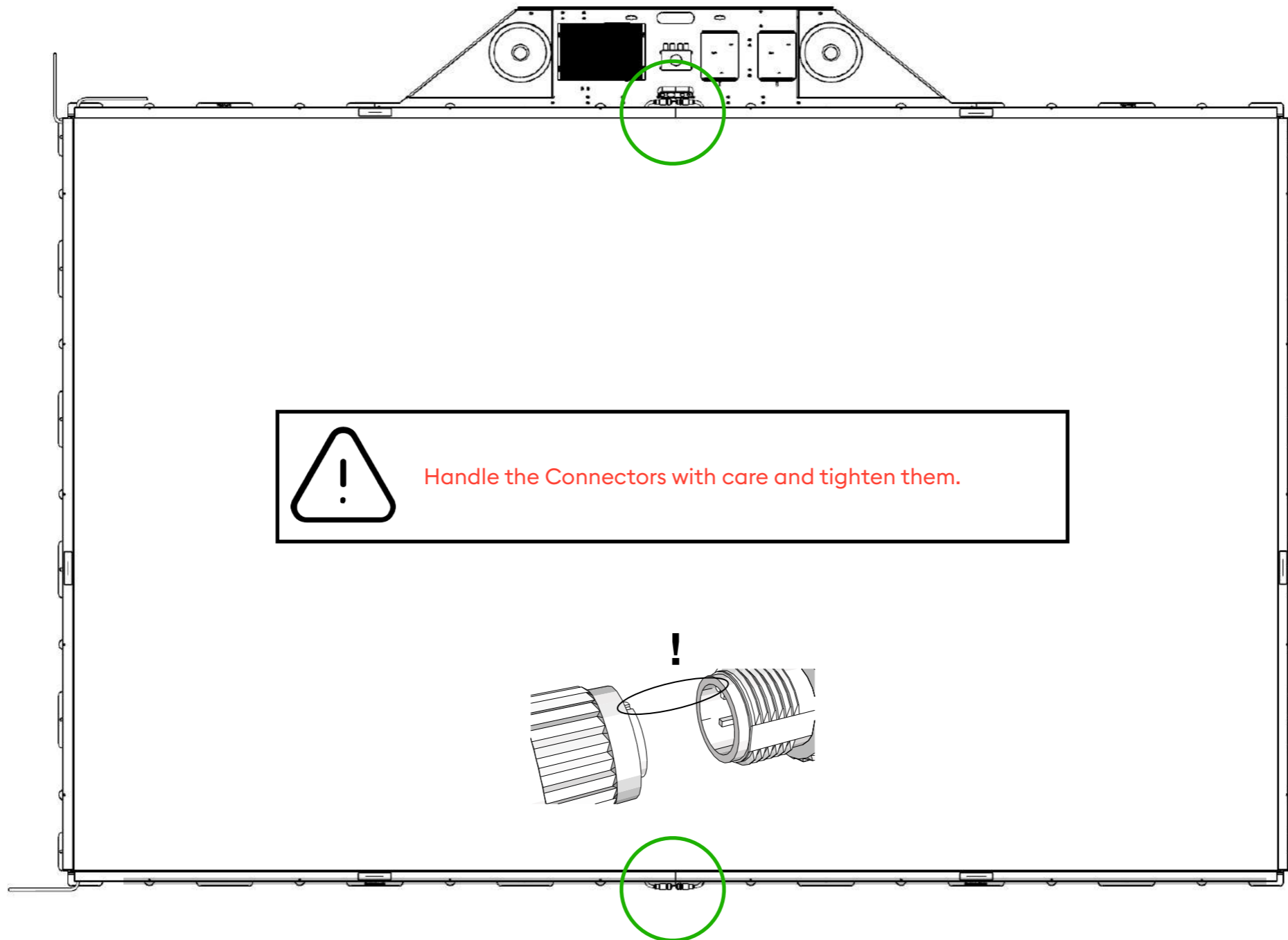

# Step 5

## Cable connections

Connect the Sensor Cables with the Controllers.

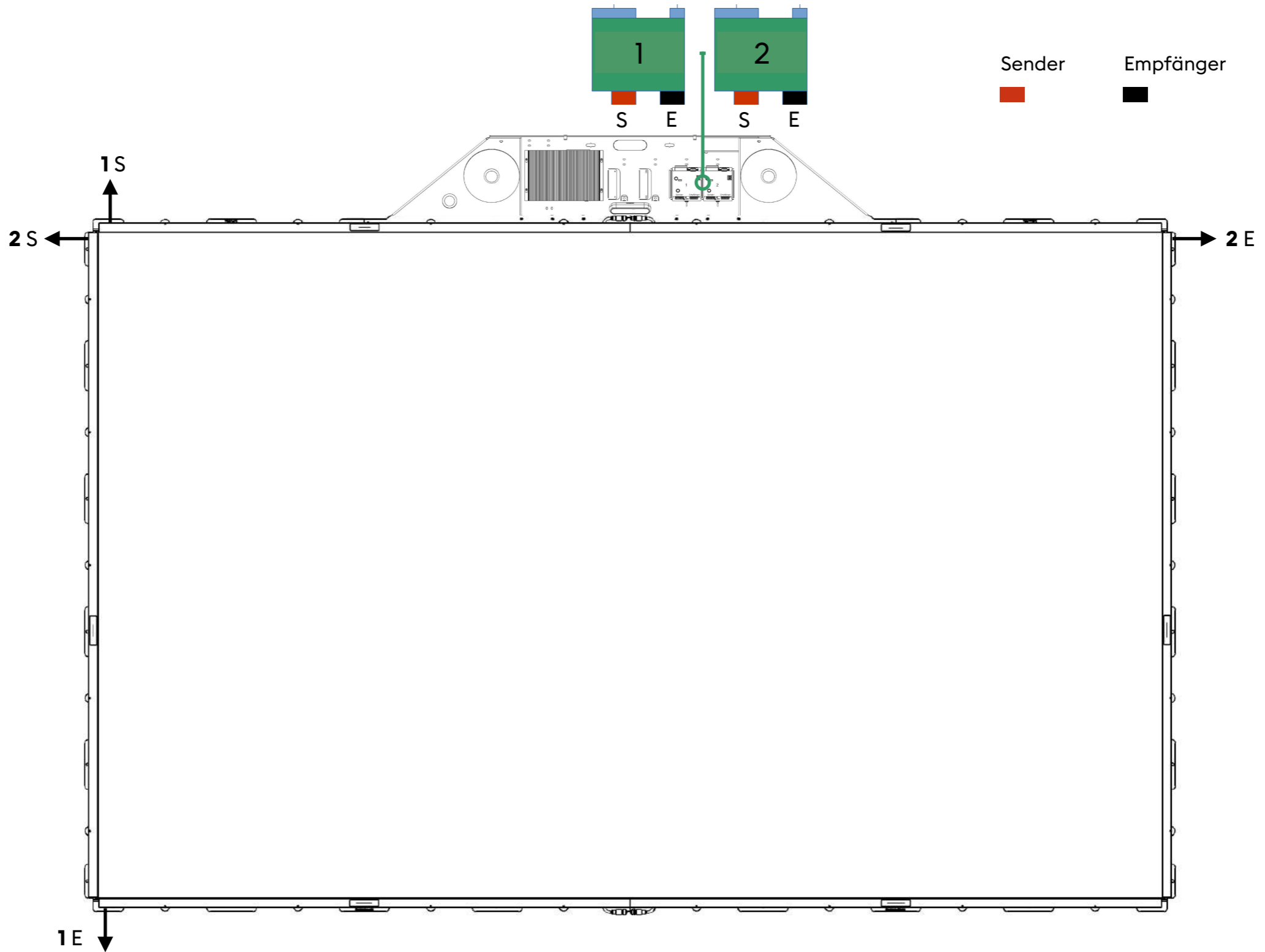

# Step 5

## Cable connections

1. Connect the Console to power outlet and to Internet.
2. Connect the projector via HDMI.

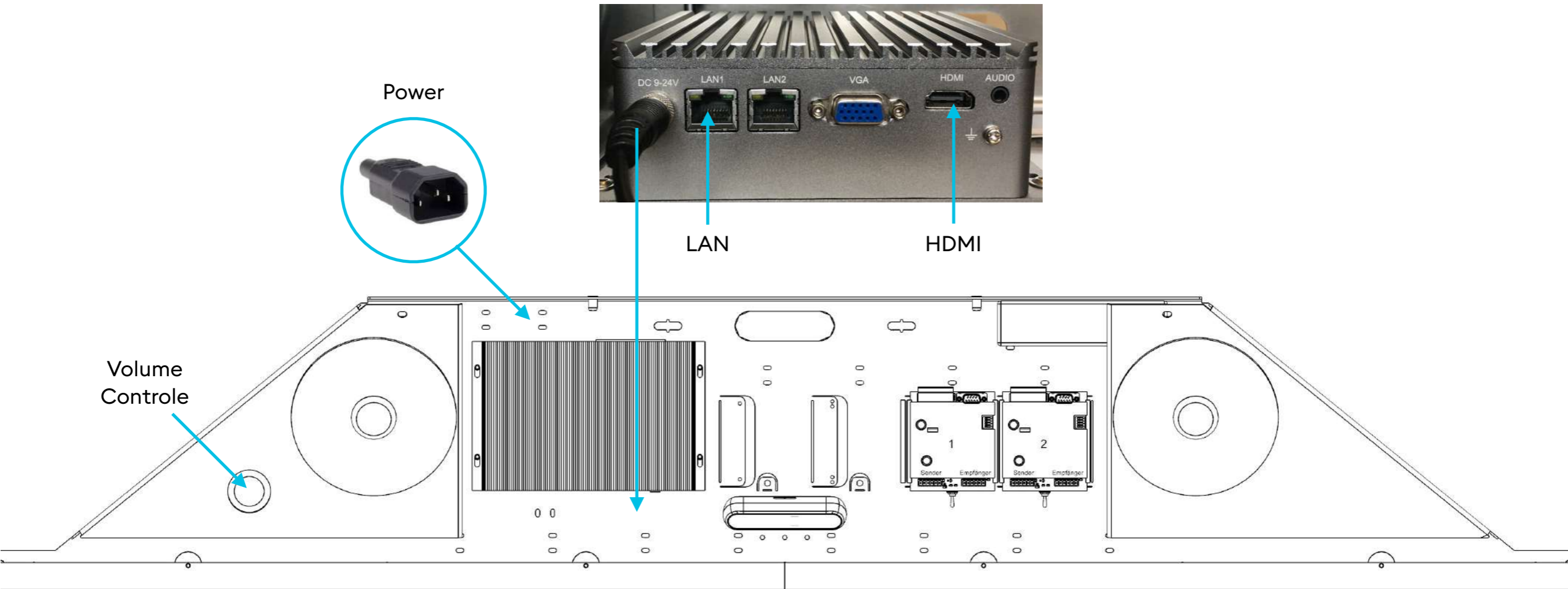

## Step 6

### Setup Controller (1 and 2)

1. Power off Controller 1 and 2 by the switches.
2. Switch up the DIP 3 on Controller 1.
3. Power on the Controller 1.
4. Switch down the DIP 3 on the Controller 1 and wait until the „OUT 4 / IN 2“ green LED comes up. (if this light never went off, please wait 5 seconds)
5. Test the sensor by touching the wall:
  - "OUT 1" green LED blinks as you interfere the light bars.
  - Center LED blink in a steady interval to show that the unit is alive and working.
6. Power off Controller 1 and repeat the same steps with Controller 2, starting from step 1 - 6 and move on to step 7.
7. Power on Controller 1 and 2.

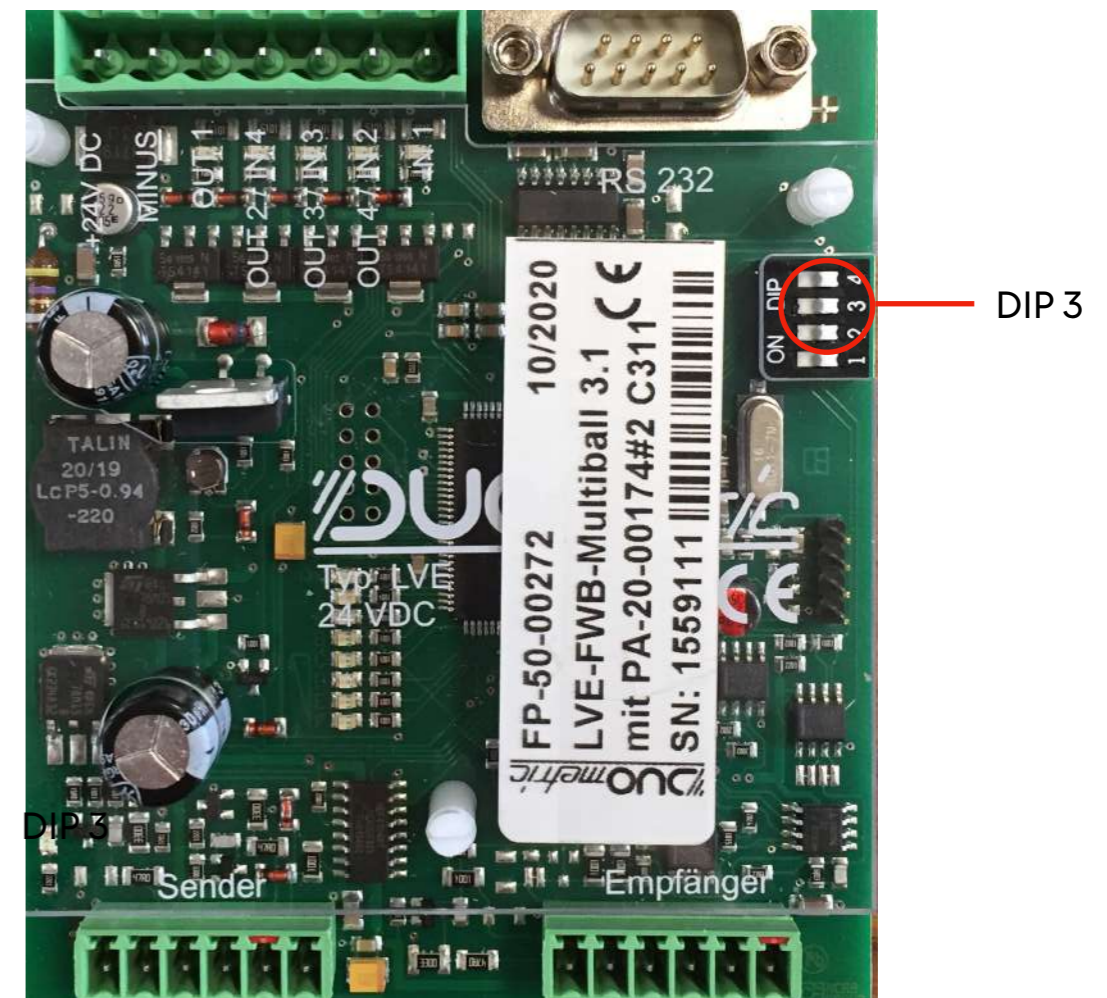
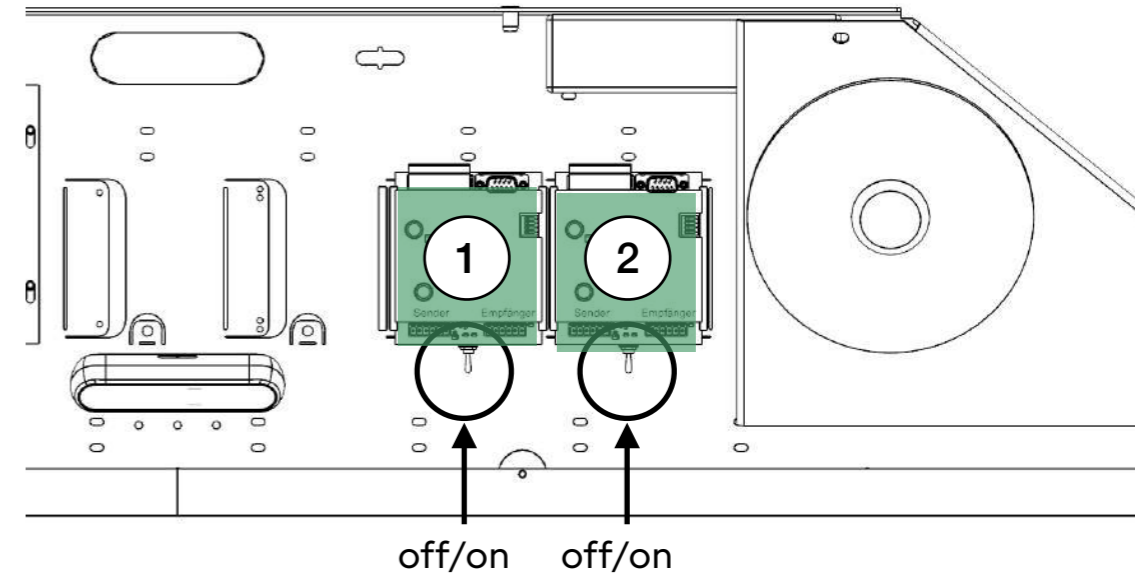

- Don't change any of the DIP in the MB sensors except DIP 3
- During the sensors testing: LEDs in the center show the signal's strength in real time and these might flicker with slight signal changes, which is FINE

## Step 7

### Mount Covers

1. Mount the Covers with the sensor holes facing inwards.
2. Use **Cover Bolt M6**.

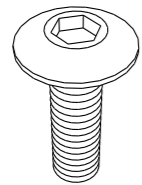

**Cover Bolt M6**

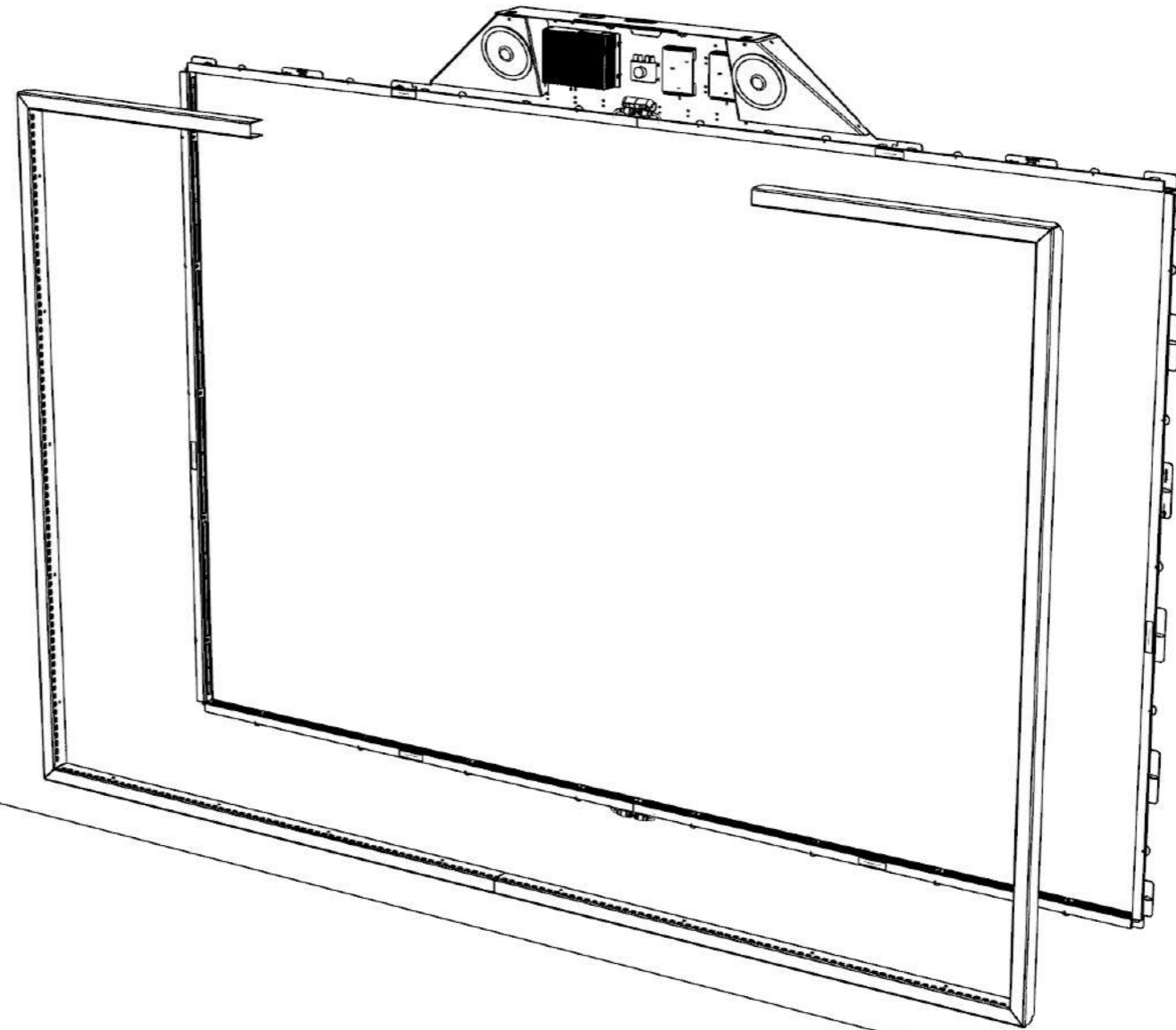

Carefully slide in the covers and avoid pinching or bending the light bar cables!  
If using an electric impact drill, make sure not to damage the white surface of the wall!



Use provided bolts.  
Once covers are on repeat Step 6 "Calibrate LVXs"



## Step 8

### Adjust Projector

1. Disconnect the Console from the power outlet.
2. Switch on the projector.
3. Connect the Console to the power outlet.

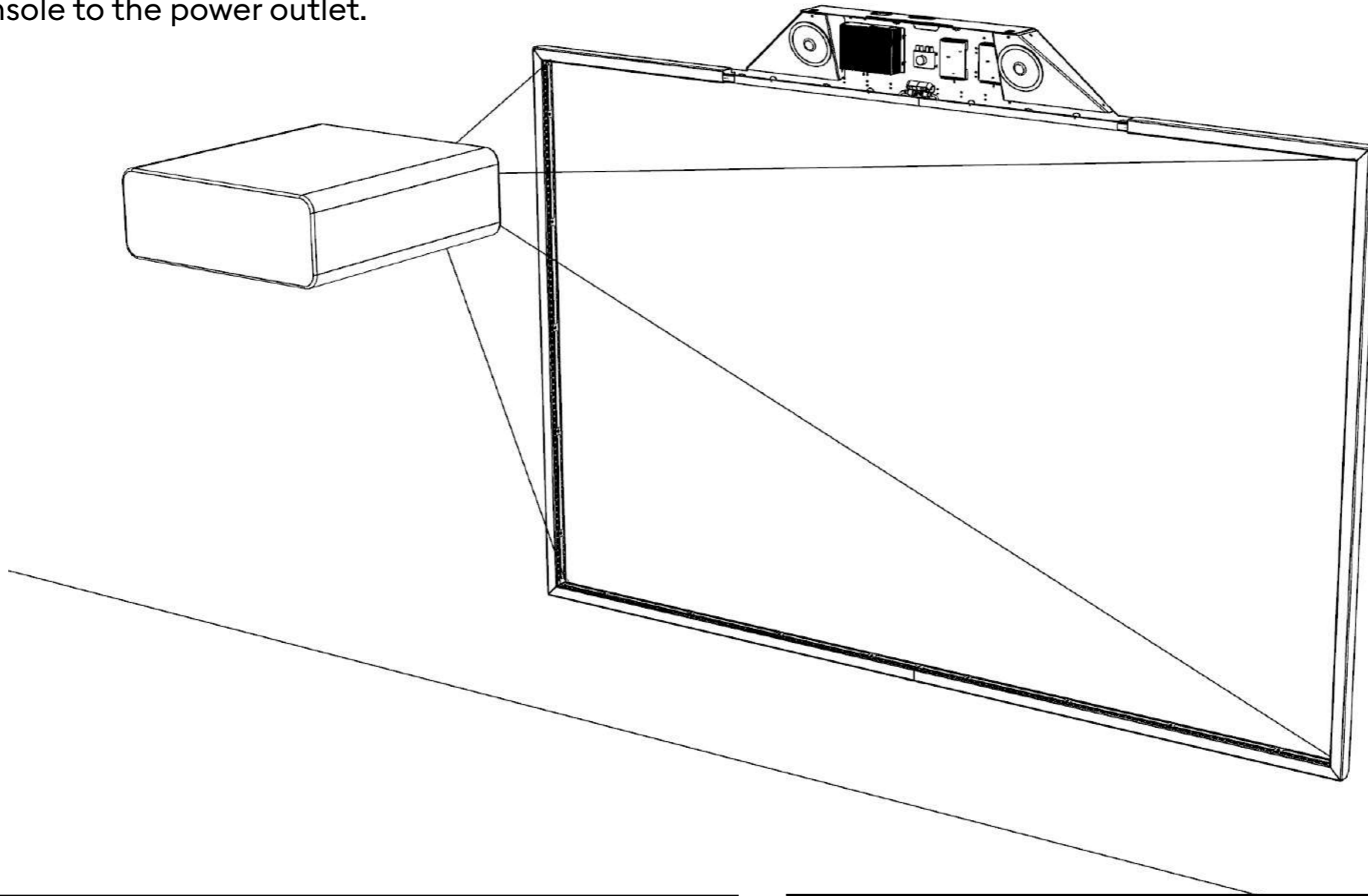

To get a picture, always make sure you power on the projector first and then the MultiBall console.  
If the game does not fit in the visible picture, get in touch with us so we can remotely change the settings



Using 'Shift' and 'Corner Correction' in your projector, align the picture so it perfectly fits into the frame.  
Now it is time to test the system for the first time. Everything should run smoothly.

## Step 9

### Mount MultiBall Console Cover

1. Put back the Cover.
2. Use **Cover Bolt M6**.

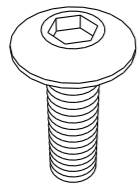

**Cover Bolt M6**

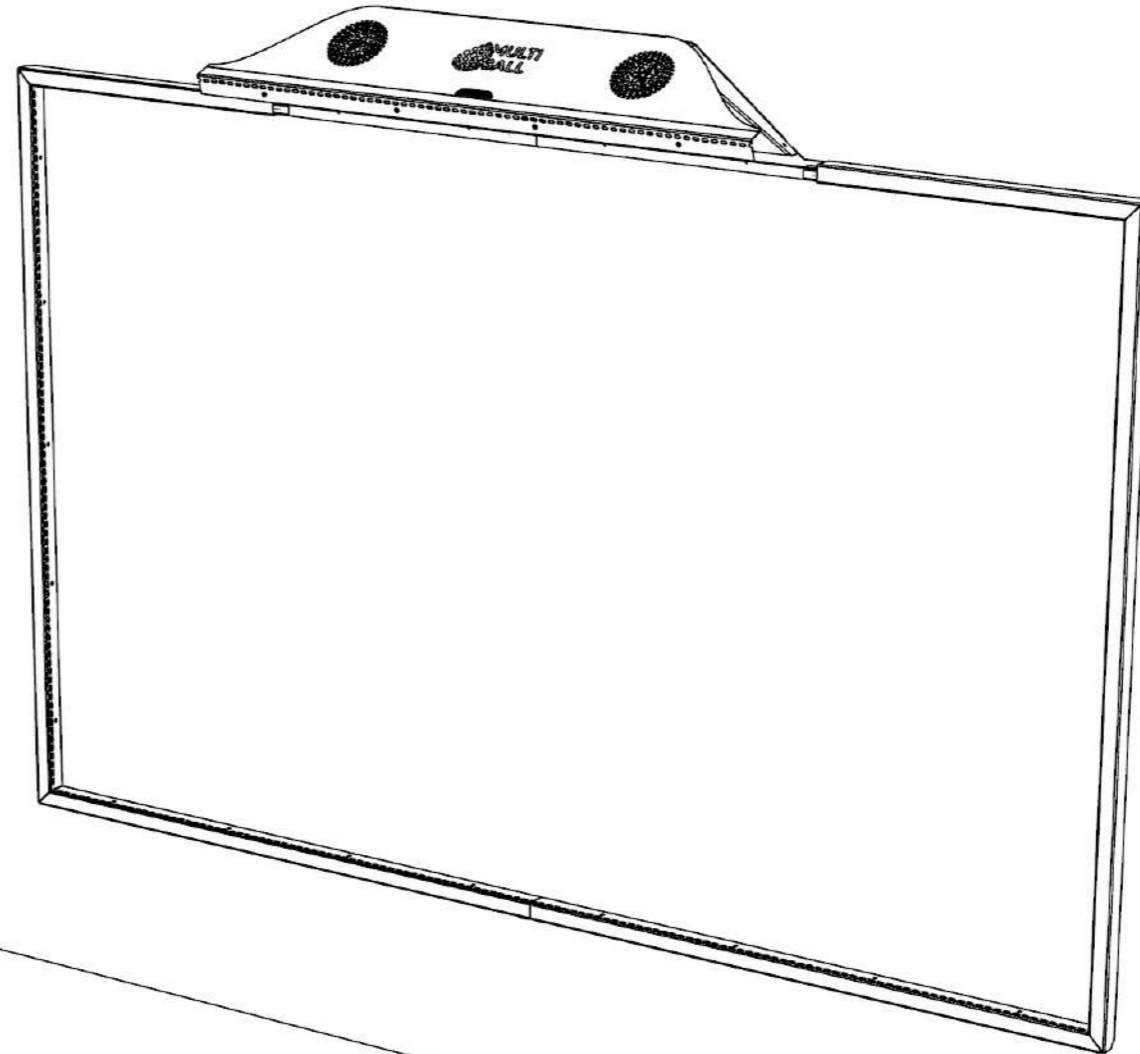



Use this step to adjust the volume of the amplifier. The volume can also be adjusted in the menu so try to find the best level suitable for you.

# Maintenance

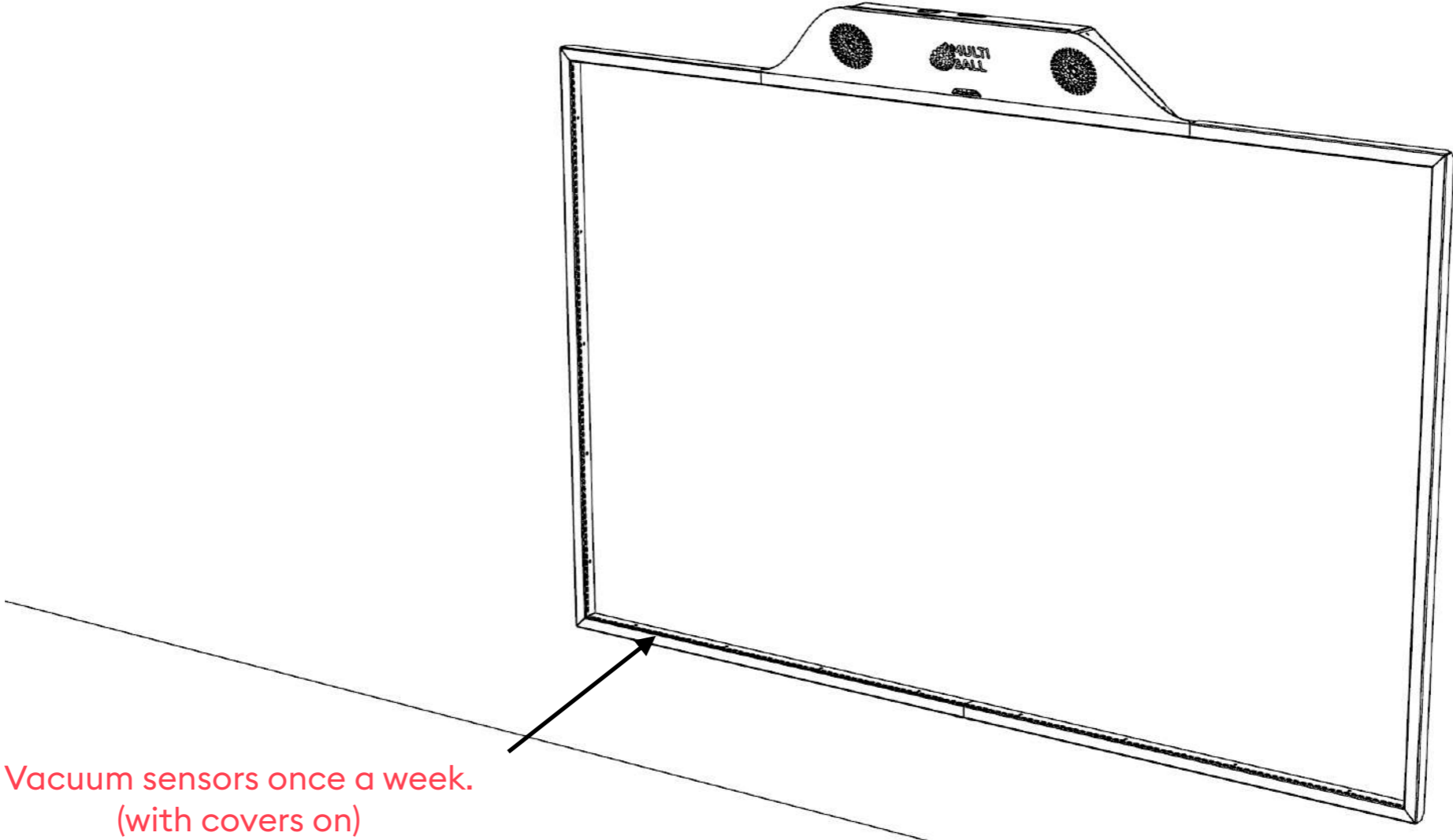
- 1. Do not block the Sensors.
- 2. Do not step on the Sensor Frame.



 In case of any problems of system not working, always first check the Sensors if they are clean and without any obstruction.

 Take care of the system to avoid any kind of physical damage.

# Home Screen

1. Choose between Games and Trainings.
2. Start by touching an icon.
3. Remote control by Smart Phone.

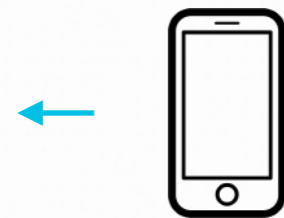
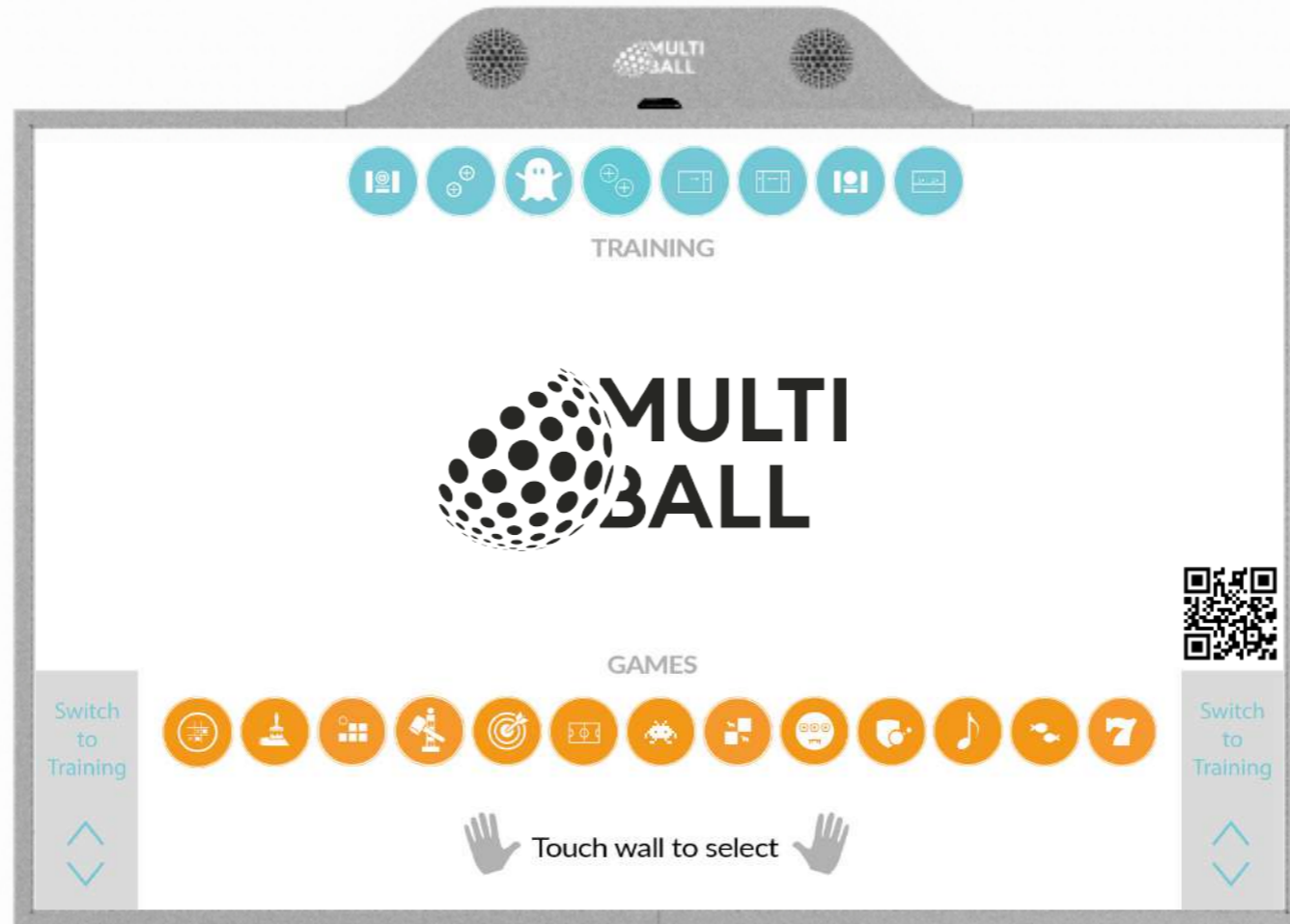

Scan QR-Code to connect with the MultiBall Smart Phone App.

# In-Game Menu

1. You can open the In-Game menu by touching the surface while playing a game.
2. Here you can go back to the home screen, resume or restart the game and adjust the volume.

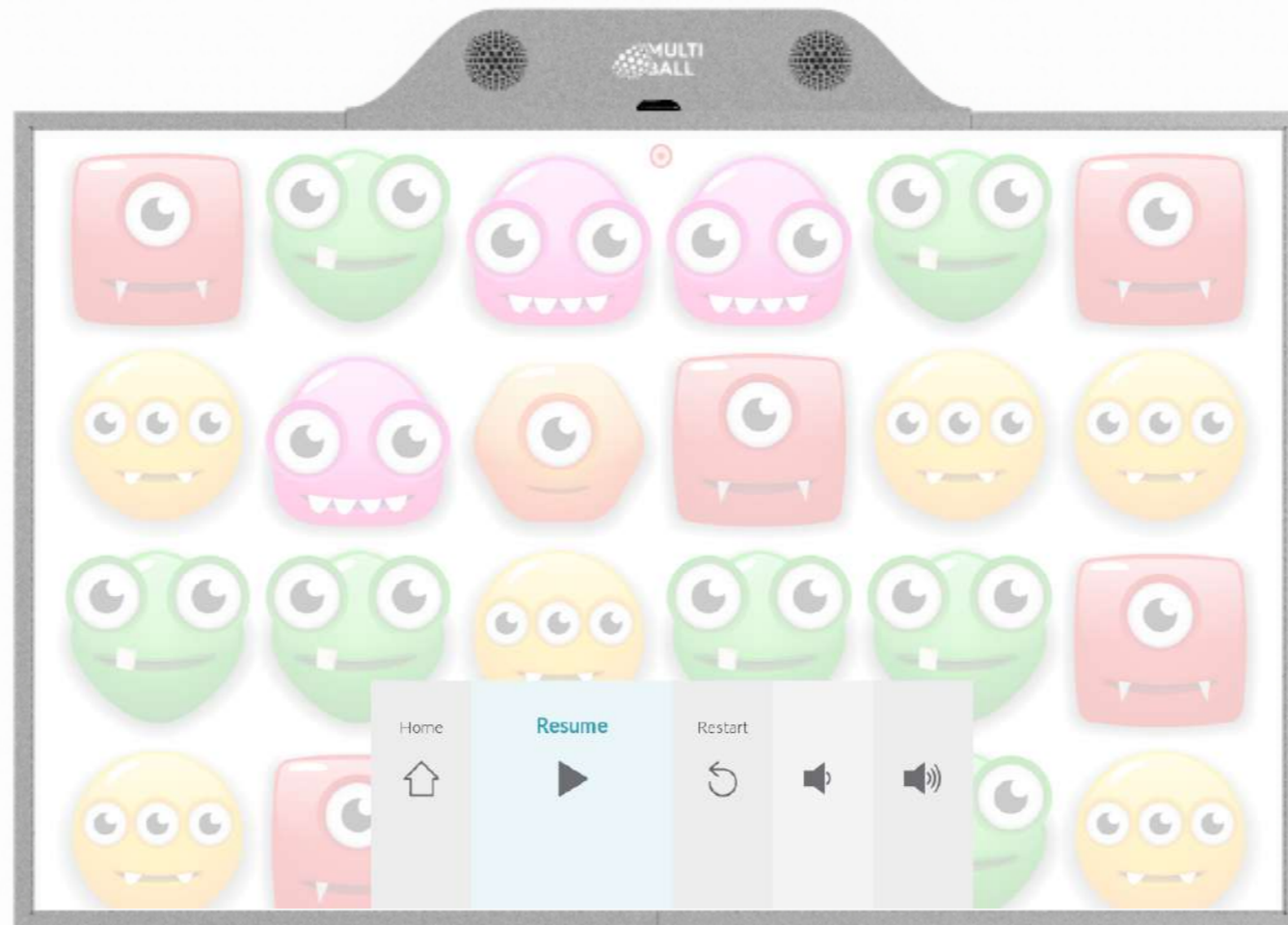

# MultiBall Sportification App

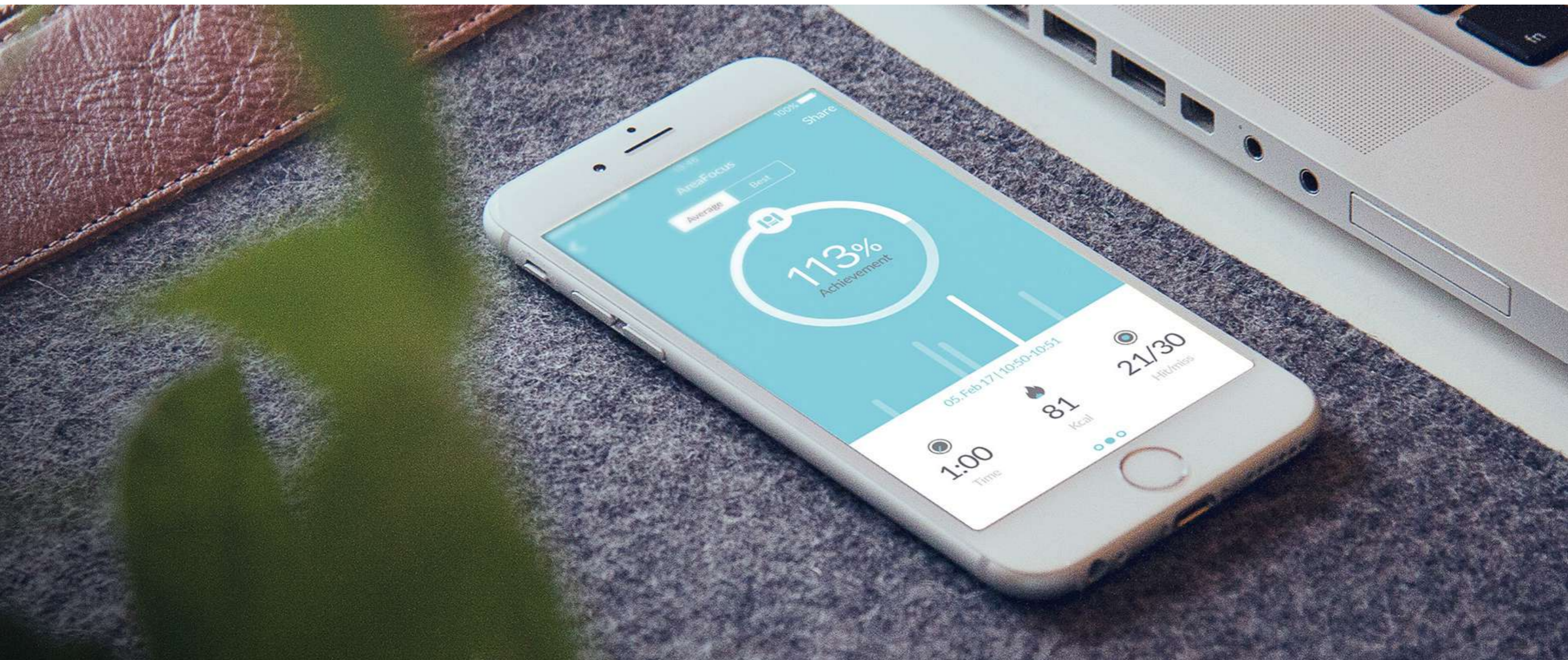

## App download:

[Apple](#)  
[Android](#)

FUN WITH BALLS GmbH  
Gyßlingstraße 72  
80805 München  
Germany  
+49 89 323 099 61  
[www.funwithballs.com](http://www.funwithballs.com)

[www.multi-ball.com](http://www.multi-ball.com)