

S16-0134VEL10
Top Cap

S16-0134VEC
Top Cap End Cap

$\frac{9}{16}$ " Laminated Glass

S17-0073
Cladding End Cap

S16-0073FVEL10
Flat Cladding

A42-0073AEYSD20
Panel Grip Base Shoe

S16-0073WVEL10
Wrap Cladding

A42-0028-1B
Panel Grip Isolator

SECTION A-A
SCALE 1:8

SECTION B-B
SCALE 1:8

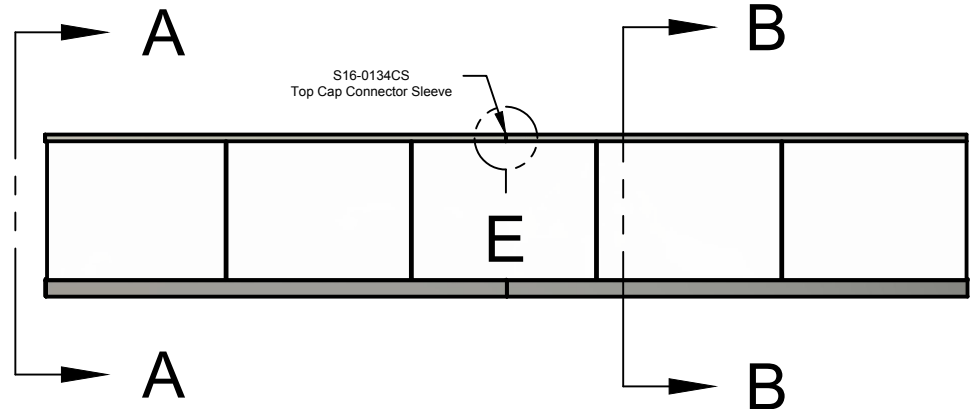
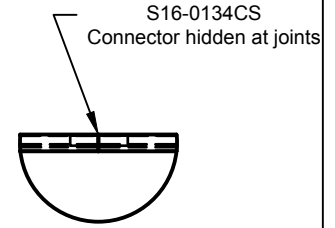
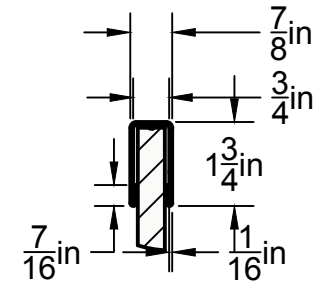
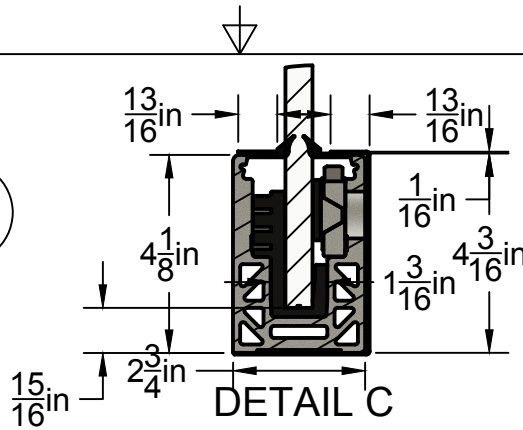

Project: Railing Products and Mock Ups

Title: 0073SD 9.16 in, Clad., No H.R., Top Cap.

Description:



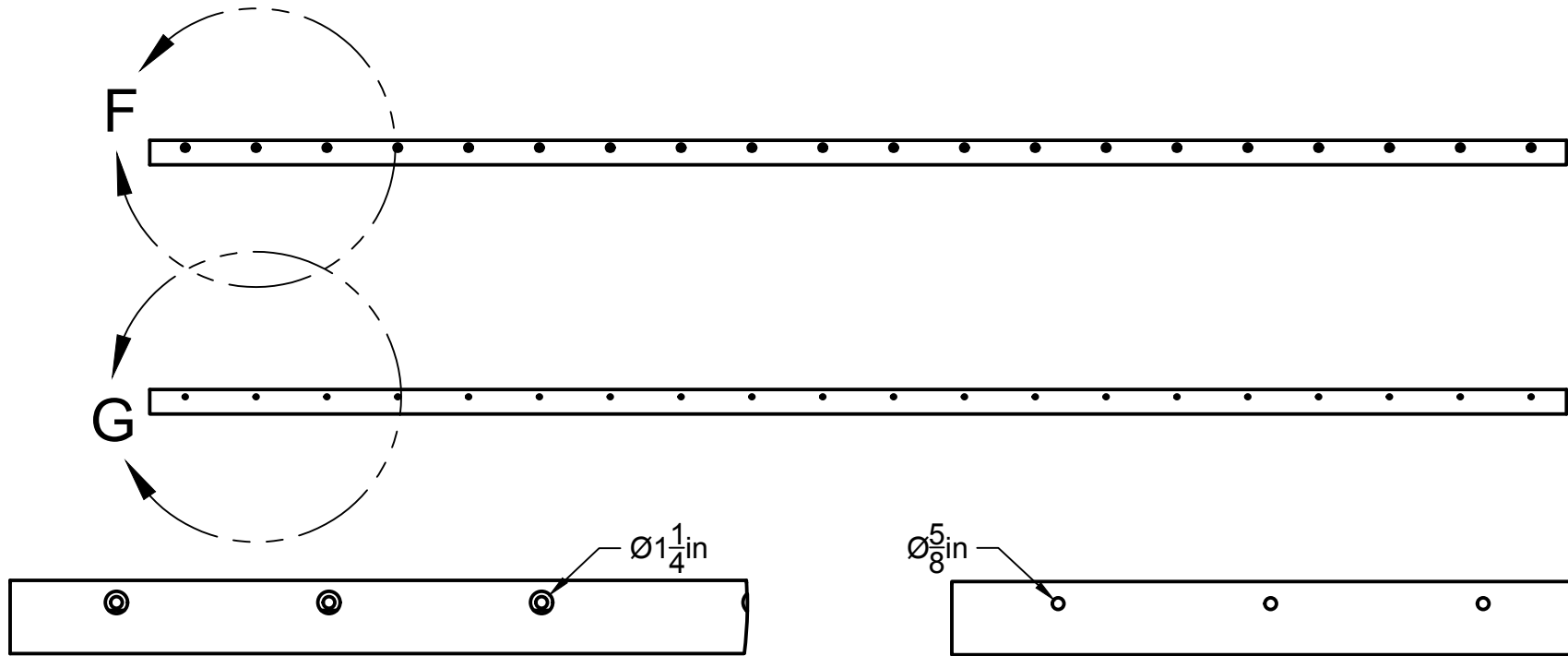

Scale: 1:50

Date
Drawn: 6/5/2019



DETAIL F
SCALE 1:10

DETAIL G
SCALE 1:10

Project:	Railing Products and Mock Ups
Title:	0073SD 9.16 in, Clad., No H.R., Top Cap.
Description:	
 <p>An  Company</p>	Scale: 1:50
	Date Drawn: 6/5/2019