



- Ⓘ PREPARATORE A DISCHI
- Ⓖᅇ DISC CULTIVATOR
- Ⓓᅇ KURZSCHEIBENEGGEN

Maratona MG 300 350 400



Preparatore a dischi combinato con seminatrice
Disc cultivator combined with seed-drill
Kurzscheibenegege kombiniert mit einer Drill-Maschine



Attacchi al trattore di 2° e 3° categoria.
 Linkage cat. 2 and 3.
 Schlepper Kuppelung Kat. 2 und 3.

Dischi dentati in acciaio ad alta resistenza.
 Discs made of high tensile steel.
 Gezackte Hohl scheiben aus Spezial Stahl.



Cuscinetti speciali Long-Life senza obbligo di manutenzione.
 Poca manutenzione, garanzia di qualità.

Special, "Long-life" ball-bearings.
 Very little maintenance required. Quality guarantee.

"Long-Life" Scheibenlagerung "Wartungsfrei".
 Geringe Wartung. Qualität Garantie.

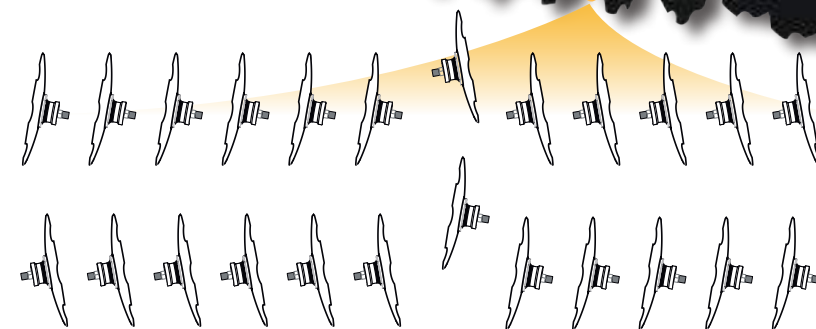

Posizionamento dischi a Spina di pesce, per una corretta distribuzione dei carichi.
 Counteracting discs for a correct of stresses distribution.

Fischgräten-Anordnung der Scheiben für optimale Bodenananpassung und Verteilung der Lasten.

DATI TECNICI / TECHNICAL DATA / TECHNISCHE DATEN

	HP	mm	mm	mm	(n°)	KG	
Maratona MG-300	120-200	3000	3000	460	24	2500	
Maratona MG-350	130-200	3500	3500	460	28	3055	
Maratona MG-400	140-200	4000	4000	460	32	3360	

ACCESSORI / OPTIONS / ZUBEHÖR



Rullo Packer
 Packer roller
 Packer Walze

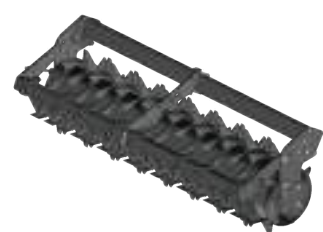

Rullo Gomma
 Rubber roller
 Gummi Walze

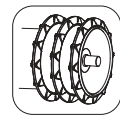

Rullo Trapezio
 Trapezio roller
 Trapez Walze

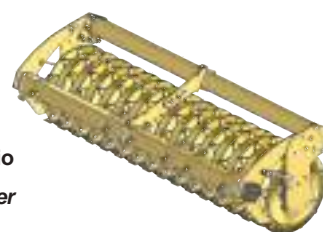

Dischi dietro le ruote del trattore regolabili singolarmente in altezza.

Working depth of the discs individually adjustable behind the tractor wheels.

Einzel in der Tiefe einstellbare Scheiben hinter den Schlepper-Rädern.

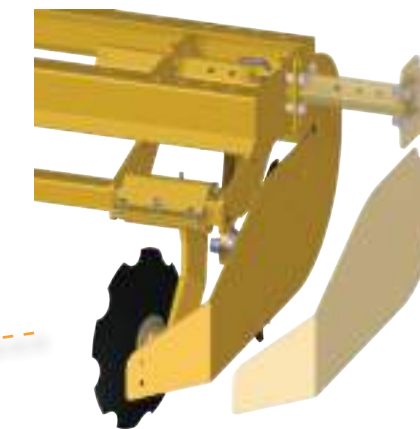

Fiancate mobili, elasticizzate e rientrabili in sagoma: a seconda del flusso di terra generato dai dischi anteriori laterali è possibile regolare le fiancate per un miglior contenimento delle zolle e conseguente deflusso nel rullo compattatore.

Elastic and extendable side plates: according to the soil flow it is possible to adjust the side plates in order to better direct clods towards the roller.

Die Seiten-Bleche sind mobil, geFedert und können zurück gezogen werden: je nach dem von den Seiten-Scheiben erzeugten Erden-Fluss ist es möglich, die Seiten-bleche für eine bessere Einschränkung der Erdschollen und deren Fluss auf die Stützwalze einzustellen.

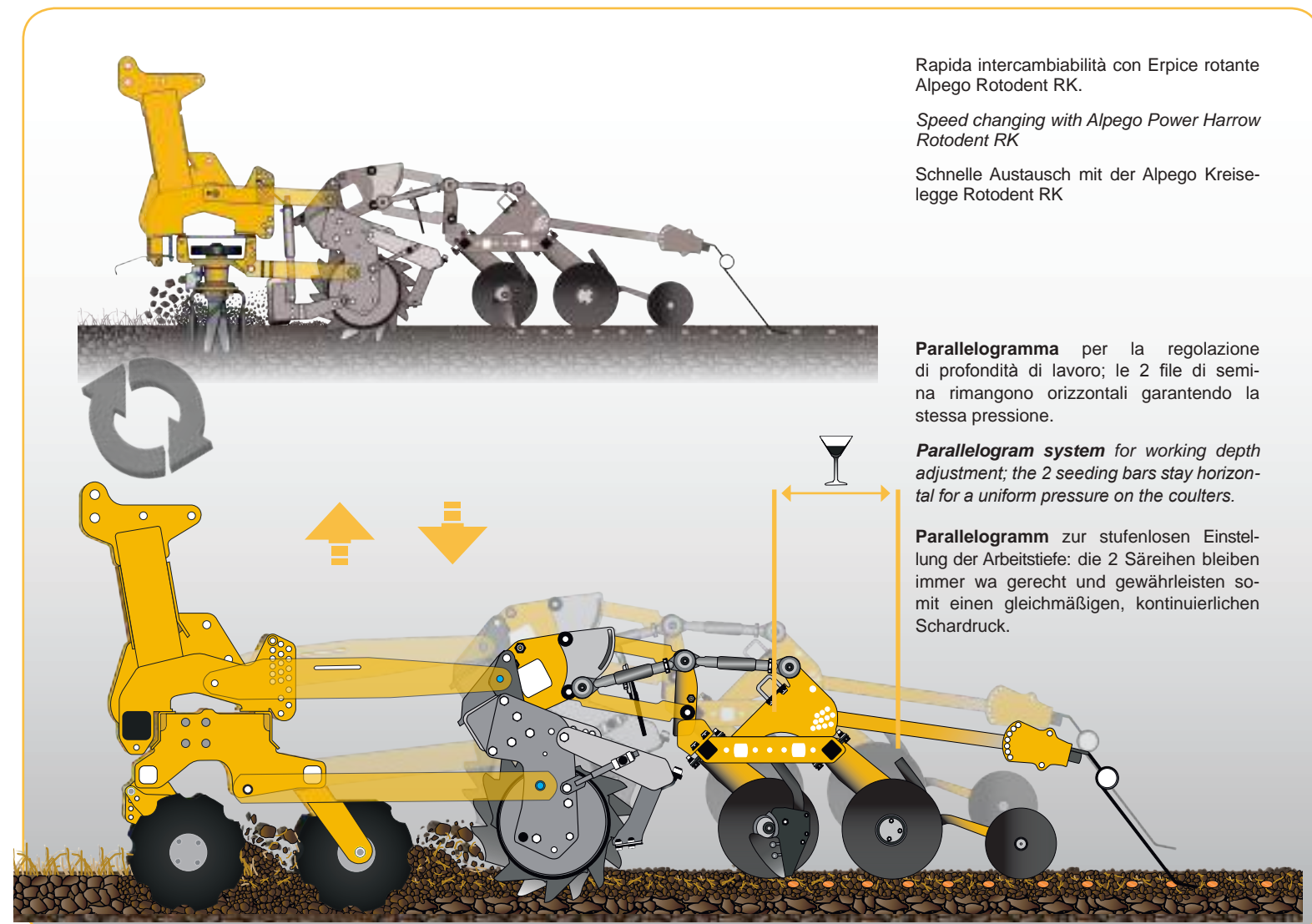

Rapida intercambiabilità con Erpice rotante Alpego Rotodent RK.

Speed changing with Alpego Power Harrow Rotodent RK

Schnelle Austausch mit der Alpego Kreiselege Rotodent RK

Parallelogramma per la regolazione di profondità di lavoro; le 2 file di semina rimangono orizzontali garantendo la stessa pressione.

Parallelogram system for working depth adjustment; the 2 seeding bars stay horizontal for a uniform pressure on the coulters.

Parallelogramm zur stufenlosen Einstellung der Arbeitstiefe: die 2 Säreihen bleiben immer wa gerecht und gewährleisten somit einen gleichmäßigen, kontinuierlichen Schardruck.

The best Technology in the Field

ERPICI ROTANTI

Power harrows / Kreiseleggen

1.10 - 8.00 mt
50 - 500 HP



FRESATRICI

Rotary cultivators / Fräsen

1.60 - 4.00 mt
50 - 280 HP



RIPUNTATORI

Subsoilers / Tiefenlockerer

1.60 - 5.00 mt
80 - 500 HP



SEMINATRICI

Seed-drills / Drill-maschinen

2.50 - 8.00 mt
80 - 500 HP



TRINCIATRICI

Flailmowers / Mulchgerät

1.10 - 3.20 mt
40 - 160 HP

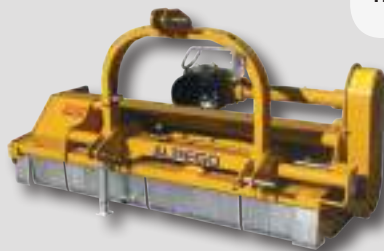

COLTIVATORI

Cultivators / Schwere Universalgrubber

3.00 - 5.00 mt
120 - 320 HP



Alpego S.p.a
Via Giovanni e Giuseppe Cenzato,9
36045 Lonigo (VI) Italy
Tel. +39 0444646100
Fax: +39 0444646199
www.alpego.com
info@alpego.com

Immagini e dati inseriti nel presente catalogo non sono impegnativi e possono essere modificati in ogni momento senza obbligo di preavviso.
Images and texts here represented cannot be considered binding and can be modified at manufacturer's discretion.
Die in diesem Katalog eingetragenen Bilder und Angaben sind nicht bindend und dürfen zu jeder Zeit ohne Vorwarnung geändert werden.

Q10A00135/3 - DEPLIANT "Preparatore a dischi MARATONA MG"
IT-GB-DE 23/02/2017

Copyright © by ALPEGO