

# Guidelines for use of Mercury™ / Mercury+™



## Miniature OCXOs in Network Timing Applications

This application note gives best practice advice on how to optimize the performance of Rakon's miniature OCXOs in network timing and synchronization applications (date of issue: 2020-12-15)

### Scope

The information in this application note applies to Rakon product models:

- RFPO40 / RFPO45 (Mercury™ 9 x 7 mm)
- RFPO50 / RFPO55 (Mercury™ 14 x 9 mm)
- ROM7050Xx / RTH7050x (Mercury+™ 7 x 5)
- ROM9070Xx (Mercury+™ 9 x 7)
- ROM1490Xx (Mercury+™ 14 x 9)

### Introduction

In an OCXO, the effect of ambient temperature is virtually eliminated by enclosing the entire oscillator within an 'oven' maintained at a constant high temperature. As conventional OCXOs tend to be bulky and power-hungry, Rakon developed the Mercury™ / Mercury+™ series of miniature OCXOs.

In the Mercury™ / Mercury+™ OCXO a miniature oven keeps a crystal oscillator at a constant temperature slightly above the specified operating temperature range, for example at  $\approx 92^{\circ}\text{C}$  for a device with an operating temperature range of  $-40^{\circ}\text{C}$  to  $+85^{\circ}\text{C}$ .

Every device is tested over the full operating temperature range in a temperature chamber. The operating temperature specified in the data sheets is that of the air in the vicinity of the OCXO. Please note that heat sources near the OCXO may lift the board temperature above that of the air. If the internal temperature of the OCXO rises above its specified maximum operating temperature because of convection heating within the customer's module, the OCXO will no longer maintain its stability. This can occur even if the air temperature external to the OCXO is still below the OCXO's maximum operating temperature.

Heat is generally considered an unwanted by-product in electronic assemblies but it is important to realize that heat is that what gives an OCXO its stability. Provided the board temperature stays below the maximum operating temperature there is no need to cool the device – in fact cooling can be detrimental to an OCXO's short and medium term stability.

### General Guidelines

Please consult Rakon from the start of the program and continue the engagement throughout the development. An evaluation board is available to assist with bench testing of the Mercury™ / Mercury+™ OCXO. This board can accommodate the various package format options.

## Power Supply Considerations

We recommend using a local low-noise power supply regulator to isolate the OCXO from external power noise sources. An example of such a regulator (Linear Technology's LT1763 series) is shown in figure 1.

Figure 1: 3.3 V Low Noise Regulator

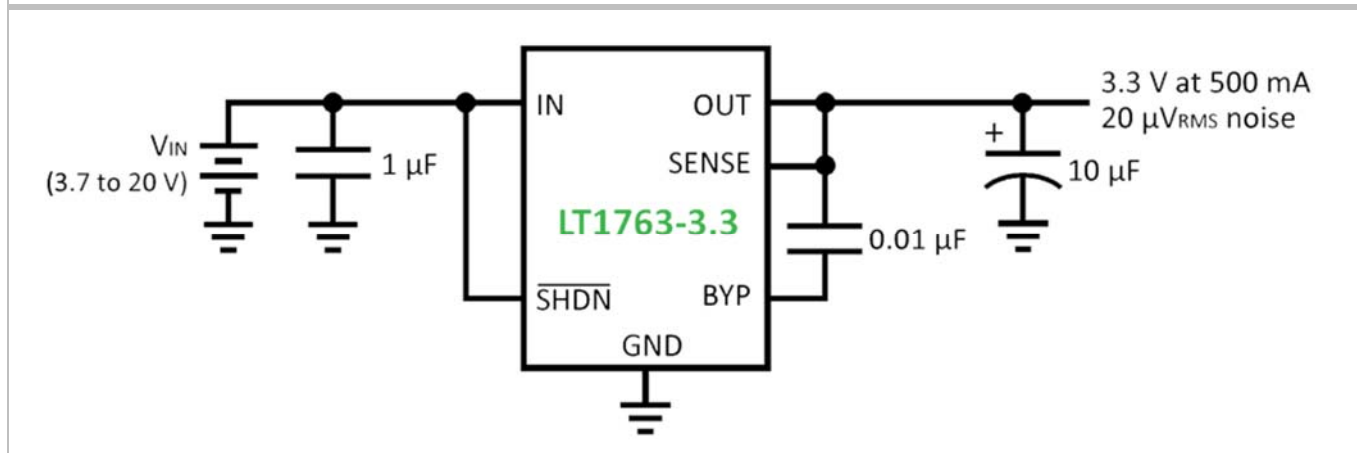

The local supply must be dimensioned in such a way that it can handle the warm-up current of the OCXO. The warm-up power of the OCXO is programmed to limit at a certain value. The default warm-up and steady state power consumption limits can be found in following table (check the detail specification for the specific values of the DUT as this will depend on a number of factors like e.g. the operating temperature range specified for the device).

Power consumption	Warm-up	Steady-state at 25°C
RFPO40 / RFPO45, RFPO50 / RFPO55 -20°C to +70°C	Max. 1000 mW (typ. 800 mW)	Max. 350 mW
RFPO40 / RFPO45, RFPO50 / RFPO55 -40°C to +85°C	Max. 1200 mW (typ. 1000 mW)	Max. 400 mW
ROM7050Xx / RTH7050x / ROM9070Xx / ROM1490Xx, -40°C to +85°C	Max. 1500 mW (typ. 1200 mW)	Max. 440 mW

We recommend decoupling the supply of the OCXO with a 10µF capacitor close to the device.

## Voltage Control

In case voltage control has been specified it is important to realize that typical gain transfer (Kv) can range from +2 to +8 ppm/V depending on technology used. A small error in the control voltage may result in a considerable frequency error. The high current going through the ground lead impedance will cause an error voltage which, if added to the control voltage, will cause a frequency error. Because of this, the ground of the control voltage needs to be connected close to the ground of the OCXO. Do not use a voltage controllable OCXO for applications that require a fixed frequency OCXO. Rakon can provide a dedicated fixed frequency OCXO instead. If reuse of a voltage controllable part is unavoidable, it is imperative that the control voltage (Vc) pin is connected to the correct nominal control voltage as per the OCXO's detail specification.

## Output Load

For optimum stability we recommend to load the output with the nominal load as stated in the detail specification as this will be the load used during calibration of the device in production. Depending on the load represented by the input driven, it may be necessary to add an additional capacitor. For example if the combined load of input and tracks is 7 pF and the nominal load is stated as 15 pF then a capacitor of  $\approx 8$  pF should be added to the output load. If the load exceeds the nominal load (by more than 5 pF) it is recommended to use a fan-out buffer. When testing the OCXO please be aware that the device cannot drive 50  $\Omega$  inputs directly but needs buffering (the Rakon evaluation board can be fitted with a buffer for this purpose).

## Thermal Guidelines

The OCXO detail specification is valid when steady state conditions have been reached (this assumes constant temperature and still air unless otherwise stated). A steady state is reached after a warm-up period. Warm-up is not limited to the oscillator as the circuit board on which it is mounted must also be taken into consideration. For wander compliance testing it is recommended to power-up the board for at least 24 hours (48 hours if parts were soldered recently) before commencing the measurements and to keep the temperature variation within  $\pm 1^\circ\text{C}$  (unless otherwise stated in the relevant standard).

A change in temperature external to the OCXO will result in an increase or decrease of current to the heater, as the oven is trying to maintain a constant internal temperature. This is a critically damped closed loop system and its response will lag the external stimulus resulting in phase and frequency variations (i.e. frequency wander).

For this reason, it is best to keep the external temperature fluctuations to a minimum. The main cause of short-term temperature fluctuation is variation in the flow of air when fans run at varying speeds or are used intermittently.

Power dissipating circuitry near the OCXO which is being switched on or off intermittently is another potential source of temperature variation. The change in power dissipation will disturb the OCXO's thermal balance. It is best to keep such circuitry away from the oscillator.

As there is no need to cool the OCXO, its short and medium term stability can be greatly improved by thermally isolating it from the environment. Two important factors are board layout and airflow.

## Printed Circuit Board Layout Considerations

Apply standard RF practice, keep tracks short and place the oscillator close to the timing circuitry.

Use the recommended pad layout as detailed in the specification. Whilst the use of ground and power supply planes is generally a good practice, to avoid thermal energy loss, these planes (copper pours) should not be used underneath the OCXO in any of the layers.

For the same reason do not route any tracks underneath the OCXO area. It is recommended to widen this exclusion zone beyond the size of the oscillator by at least an amount equivalent to the thickness of the board used. E.g. if an oscillator with 9.7 x 7.5 mm footprint is used on a 2 mm thick multi-layer board, the track and plane exclusion zone should be at least 13.7 x 11.5 mm.

Tracks connecting to the pads should have a width of less than 1 mm to avoid conducting heat away from the OCXO and should not connect to any layer inside the exclusion zone.

To further minimize heat transfer between the OCXO and the board it is recommended to cut 1-2 mm wide slots in the board around the OCXO. If it is not possible to implement these recommendations, please contact Rakon to discuss potential alternative solutions.

## Airflow Considerations

In order to meet the specification shield the OCXO from airflow. Place the oscillator where flow is low. It may be possible to use tall components or mechanical parts to shield the oscillator locally.

If shielding this way is not possible or insufficient, a draft cover may be placed over the OCXO. Any material (e.g. metal or plastic) can be used as long it is airtight.

Rakon recommends such a cover if the airflow is greater than 0.5 m/s.

It is recommended that the cover leaves an air-gap of at least several ( $\geq 2$ ) mm above and around the oscillator.

The following graphs show the effect of airflow (at 1 m/s) when switched off and on intermittently. Figure 2 shows Mercury™ performance without shielding and figure 3 shows the same device with a draft cover in place. Note we have used the least stable model to demonstrate the remedial effect of a draft cover on airflow. Models less sensitive to airflow are available.

Figure 2:

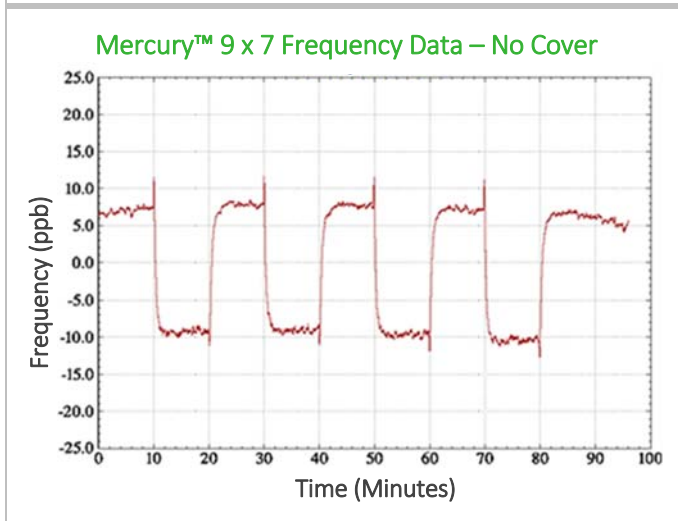
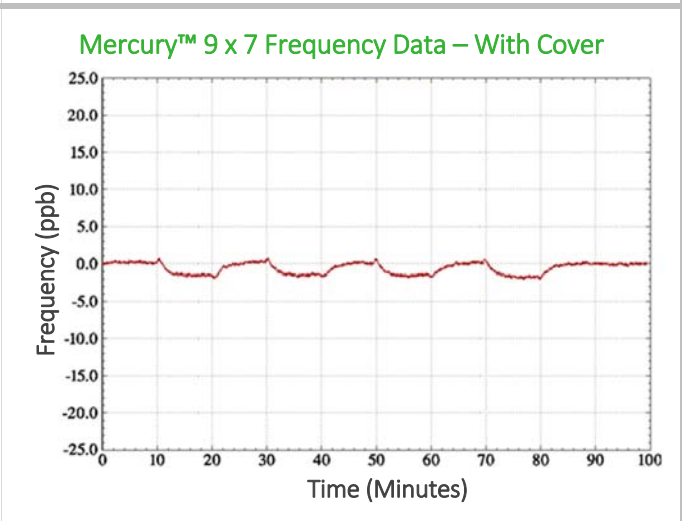

Figure 3:



Rakon can provide the following draught covers to shield the device from air flow:

Product Model	Description (SAP)	Part Number	Material ID	Outline Drawing	Assembly Drawing
RFPO40 / RFPO45 (9 x 7 mm)	Cover (16 x 14 x 11) for Mercury 9 x 7	(82)PCV00018AA3	217864	Figure 4	Figure 5
ROM9070Xx (9 x 7 mm)	Cover (16 x 14 x 11) for Mercury 9 x 7	(82)PCV00018AA3	217864	Figure 4	Figure 5
RFPO50 / RFPO55 (14 x 9 mm)	Cover (21 x 16 x 11) for Mercury 14 x 9	(82)PCV00018AA4	217865	Figure 6	Figure 7
ROM1490xx (14 x 9 mm)	Cover (21 x 16 x 11) for Mercury 14 x 9	(82)PCV00018AA4	217865	Figure 6	Figure 7

The covers need to be secured with adhesive. Any adhesive suitable for bonding components to printed circuit boards can be used. Examples are Loctite 3220 and Epotek TJ1104-LH (formerly known as Epotek 102-104). These examples are provided for information only – users remain responsible for assessing suitability. For proper use of the adhesive please consult the manufacturer's Technical Data sheet and Material Safety Data sheet.

Figure 4: RFPO40 / RFPO45 Cover Outline Drawing

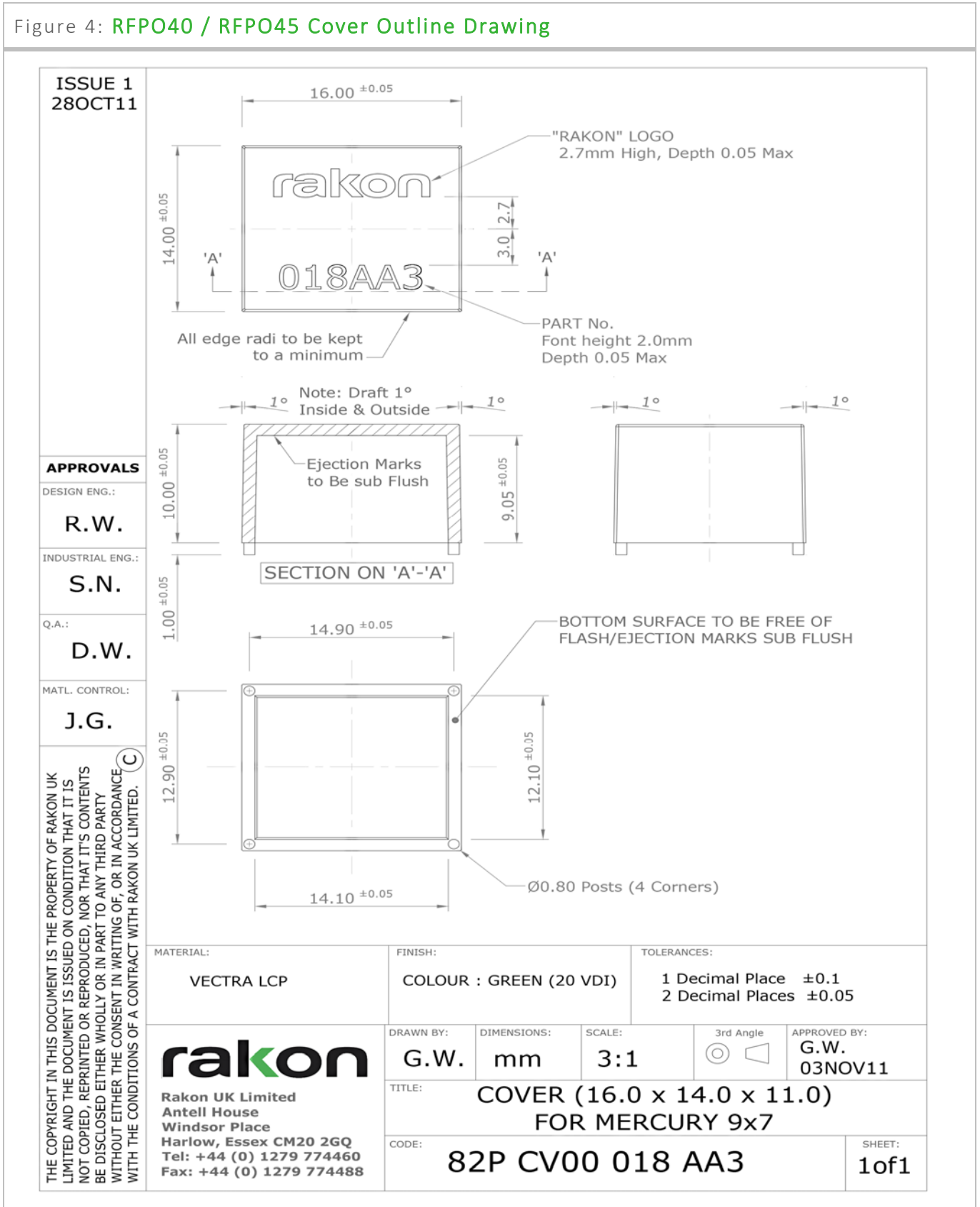

Figure 5: RFPO40 / RFPO45 Model and Cover Assembly

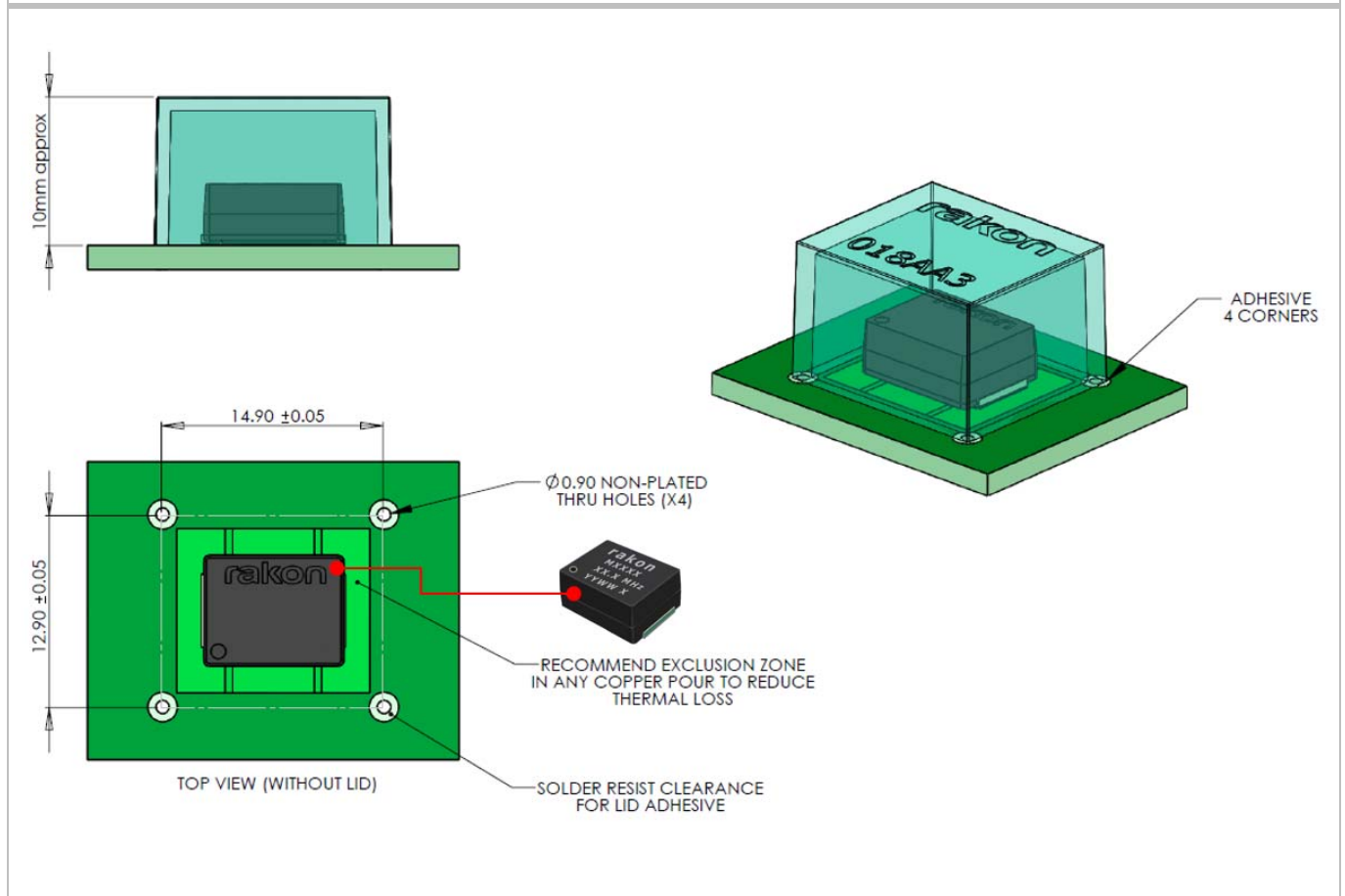

Figure 6: RFPO50 / RFPO55 / ROM1490xx Cover Outline Drawing

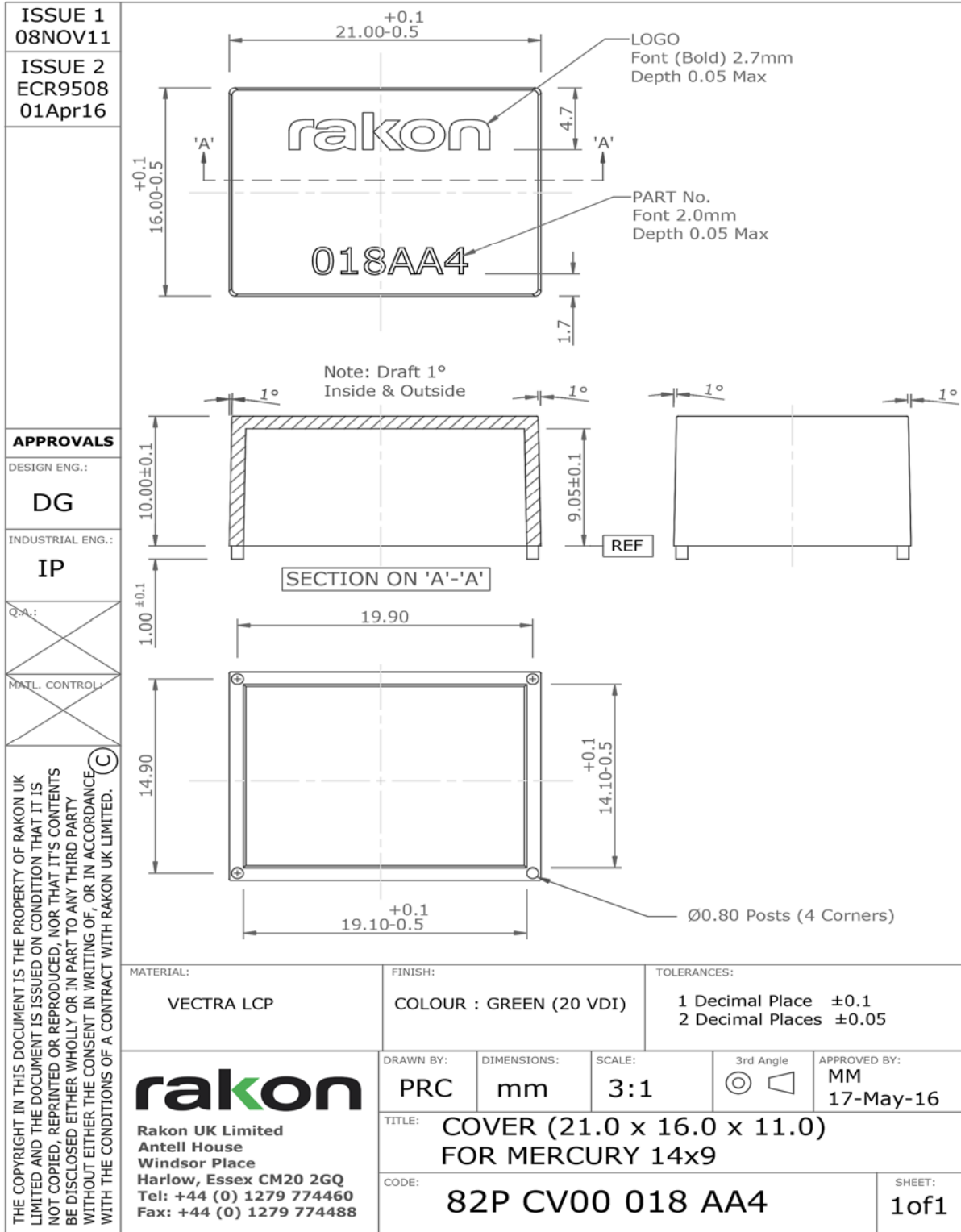
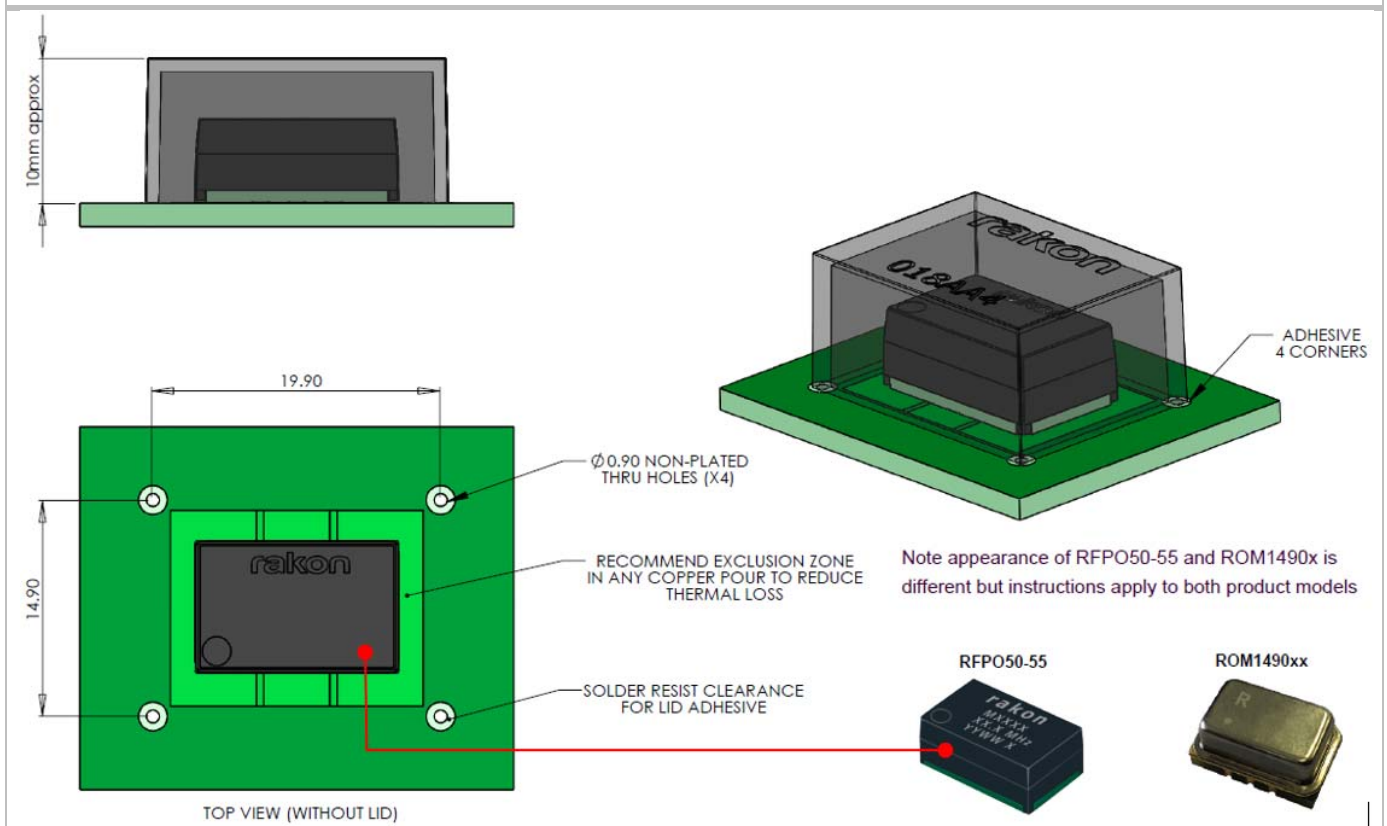



Figure 7: RFPO50 / RFPO55 / ROM1490xx Model and Cover Assembly



## Phase Noise / EVM Considerations

Getting the best phase noise out of the OCXO is a critical requirement for many applications. E.g. in base station transceiver phase noise will directly affect the Error Vector Magnitude (EVM). In order to meet the required Phase Noise / EVM performance it is important to consider the following:

- Select the output type that is suitable to drive the next stage. Please check what input signal (levels, wave shape) will give the best phase noise / EVM performance with the chip set manufacturer.
  - Mercury™ based OCXOs (RFPOxx) are available with a standard CMOS or a 1.1 V square wave output.
  - Mercury+™ based OCXOs (ROMxxxxXx) offer a choice of regulated CMOS (1.0 V, 1.8 V, 2.5 V amplitude) outputs as well as a standard CMOS output.
  - Rakon recommends Mercury+™ with one of the 3 regulated CMOS outputs for best phase noise performance.
- Use a low-noise power supply regulator (see power supply considerations) with < 20 µV supply ripple.
- Do not buffer the output signal if not required as buffers can degrade the phase noise. If buffering is unavoidable use a low noise buffer and decouple its power line from the OCXO supply with a 100Ω / 1µF low-pass filter.
- The control voltage (if part of the specification) needs to be noise free as any noise on the control voltage will modulate the carrier. To troubleshoot this it is recommended to repeat the phase noise or EVM measurement with the control voltage disconnected from its normal driving circuit but connected to a clean external voltage instead.

## Reflow Soldering

The parts are suitable for reflow soldering with a lead-free process provided the temperature profile is compatible with the one included in the oscillator's detail specification.

Note all models (except ROM1490E and ROM1490PS) are non-hermetic and cleaning liquid may become trapped after cleaning. We do not recommend cleaning these models as trapped moisture and/or residue may degrade the performance. The hermetically sealed models are washable.

The hermetically sealed models ROM1490E and ROM1490PS are not suitable for inverted reflow. Solder these parts in upright position on top of PCB only and do not let them go through any further reflows in an inverted position.